

## Industrial Cellular Router OnCell 3150A-LTE-EU

### QUICK START GUIDE



#### Contents

Safety	1
Checking the usage	2
Configuration	2
Installation	3
Wiring	4
Specifications	7
Standards and Certifications	8
Warranty	8

#### Safety

##### Please read and keep in a safe place



Please read through these instructions carefully before installing or operating. Following the installation, pass the instructions on to the operator. This unit must be installed and commissioned in accordance with the regulations and standards in force. These instructions can also be found at [www.docuthek.com](http://www.docuthek.com).

##### Explanation of symbols

• **1, 2, 3**... = Action  
> = Instruction

##### Liability

We will not be held liable for damage resulting from non-observance of the instructions and non-compliant use.

##### Safety instructions

Information that is relevant for safety is indicated in the instructions as follows:

#### DANGER

Indicates potentially fatal situations.

#### WARNING

Indicates possible danger to life and limb.

#### CAUTION

Indicates possible material damage.

All interventions may only be carried out by qualified gas technicians. Electrical interventions may only be carried out by qualified electricians.

##### Conversion, spare parts

All technical changes are prohibited. Only use OEM spare parts.



## Checking the usage

The OnCell G3150A-LTE is a reliable, secure, LTE gateway with state-of-the-art global LTE module. This 4G cellular gateway provides a more reliable connection to your Ethernet network for cellular applications. To enhance industrial reliability, the OnCell G3150A-LTE features isolated power inputs, which together with high-level EMS and wide-temperature support give the OnCell G3150A-LTE the highest level of device stability for any rugged environment. In addition, with dual-SIM GuaranLink and dual power inputs, the OnCell G3150A-LTE supports network redundancy to ensure uninterrupted connectivity.

The OnCell G3150A-LTE also comes with a 3-in-1 serial port for serial over LTE cellular network communication. Use the OnCell G3150A-LTE to collect data and exchange data with serial/Ethernet devices.

### Package Checklist

Moxa's OnCell G3150A-LTE is shipped with the following items:

- 1 OnCell G3150A-LTE unit
  - 2 2G/3G/4G antennas 2 dBi omni-directional with SMA male connectors
  - 1 DIN-rail mounting kit (mounted on OnCell)
  - Quick installation guide (printed)
  - Warranty card
- ▷ If any of these items is missing or damaged, please contact your customer service representative for assistance.

### Panel Layout

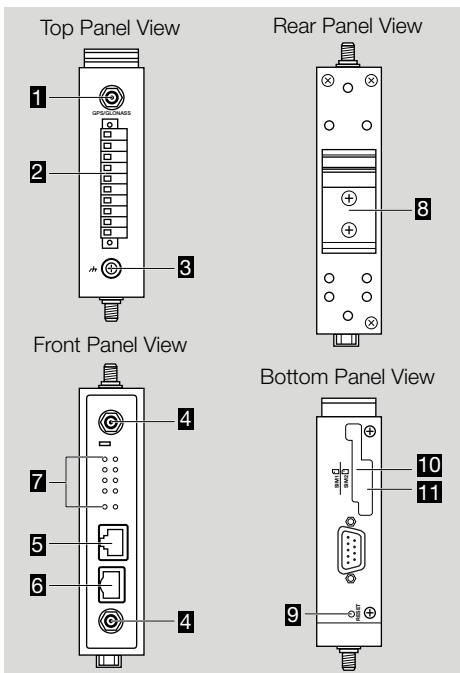

- 1 GPS antenna connector (female SMA)
- 2 Terminal block (top-down: PWR1 and PWR2, 1 digital relay and 2 digital inputs)
- 3 Grounding screw (M5)
- 4 2x2 MIMO antenna ports for LTE (female SMA)
- 5 RS-232 serial console (RJ45)
- 6 10/100 Base T(X) Ethernet port (RJ45)
- 7 LED display
- 8 DIN-rail mounting kit
- 9 Reset button
- 10 Dual SIM-SIM1
- 11 Dual SIM-SIM2

## Configuration

- ▷ Before configuring the OnCell G3150A-LTE, make sure that all items in the package checklist are in the box.
- ▷ In addition, you will need access to a notebook computer or PC equipped with an Ethernet port.
- ▷ The OnCell G3150A-LTE has a default IP address that you must use when connecting to the device for the first time.

Take the following steps to configure your OnCell G3150A-LTE. For the location of the ports and sockets, see page 2 (Checking the usage).

### Step 1: Insert a SIM card and turn on the OnCell G3150A-LTE

- 1 Use a screwdriver to loosen the screws and remove the SIM card cover.
  - 2 Insert one or two 2G/3G/4G SIM cards (full-sized SIM/1FF) into the SIM card slots located on the bottom of the OnCell G3150A-LTE.
- ▷ If you are only using one SIM card, insert it in the top slot (slot 1; the card in slot 1 is referred to as SIM1).
- ▷ By default, the SIM card in the slot 1 is treated as the primary card. To change the default to SIM2 (the card in slot 2), log in to the OnCell's web UI, and configure SIM2 as the primary card. When the OnCell device is turned on, it boots up based on the configuration information stored on the primary SIM card.
- 3 Turn on the OnCell G3150A-LTE by connecting a power terminal block to a DC power source (12 to 48 VDC).
- ▷ For details, see page 4 (Wiring).
- 4 Reattach the cover.

### Step 2: Connect the OnCell G3150A-LTE to a notebook or PC

- ▷ Since the OnCell G3150A-LTE supports MDI/MDI-X auto-sensing, you can use either a straight-through cable or crossover cable to connect the OnCell G3150A-LTE to a computer.
- ▷ See the 10/100BaseT(X) Ethernet Port Connection section below for detailed instructions.

- ▷ If the LED indicator on the OnCell G3150A-LTE's LAN port lights up, it means a connection has been established.

**Step 3: Set up an IP address for the computer**

- 4** Set an IP address on the same subnet as the OnCell G3150A-LTE.
- ▷ Since the OnCell G3150A-LTE's default IP address is 192.168.127.254, and the subnet mask is 255.255.255.0, you should set the IP address of the computer to 192.168.127.xxx and subnet mask to 255.255.255.0.

**Step 4: Use the web-based manager to configure the OnCell G3150A-LTE**

- 5** Open your computer's web browser and type `http://192.168.127.254` in the address field to access the homepage of the web-based management system.
- ▷ Before the homepage opens, you will need to enter the username and password.
- 6** For first-time configuration, enter the default username and password given below:  
Username: admin  
Password: moxa
- 7** Click on the Login button.

**! ATTENTION**

For security reasons, we strongly recommend changing the password. To change the password, select Maintenance → Username/Password, and then follow the on-screen instructions.

- ▷ You must either click the Save Configuration or the Restart button for the configuration changes to take effect.

**Installation**

**⚠ WARNING**

- This equipment is intended to be used in a Restricted Access Location, such as a dedicated computer room, where access can only be gained by SERVICE PERSONS or by USERS who have been instructed about the fact that the metal chassis of the equipment is extremely hot and may cause burns.
- Service persons or users should pay special attention and take special precautions before handling this equipment.
- Only authorized, well-trained professionals should be allowed to access the restricted access location. Access should be controlled by the authority responsible for the location with lock and key or a security identity system.
- **External metal parts are hot!!** Pay special attention or use special protection before handling this equipment.

**! ATTENTION**

- The OnCell G3150A-LTE is NOT a portable mobile device and should be located at least 20 cm away from the human body.
- The OnCell G3150A-LTE is NOT designed for the general public. A well-trained technician is required to deploy the OnCell G3150A-LTE units and safely establish a wireless network.
- For EXPLOSION-PROOF applications, the OnCell G3150A-LTE is designed and certified to meet ATEX and IECEx requirements. You should mount the device in a suitable enclosure rated at least IP54, in accordance with IEC/EN 60079-15 standard, so that it is accessible only by the use of a tool. The device is not intended for use in an area with pollution degree rating > 2 in accordance with EN 60664-1.
- When you install the OnCell G3150A-LTE in an enclosure, the antennas must also be installed in such a way that they are inside the enclosure. External antenna deployment is allowed only if the antennas are certified for ATEX Zone 2 use or confirm to IECEx standards.

**DIN-Rail Mounting**

- ▷ DIN-Rail Kit Dimensions:  
Unit = mm (inch)

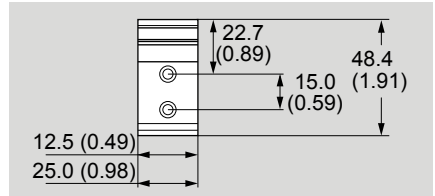

- ▷ The OnCell G3150A-LTE comes with a DIN-rail kit attached to the back panel.
- ▷ Mount the OnCell G3150A-LTE on corrosion-free mounting rails that meet the EN 60715 standard.
- 1** Insert the upper lip of the DIN rail **2** into the top hook of the DIN-rail mounting kit **1**:

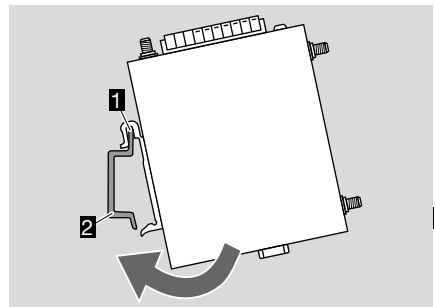

- Press the OnCell G3150A-LTE towards the DIN rail **2** until it snaps into place:

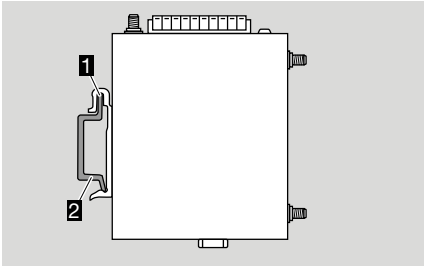

- To remove the OnCell G3150A-LTE from the DIN rail, reverse steps **1** and **2** above.

### Wall Mounting (optional)

- Wall-Mounting Kit Dimensions:  
Unit = mm (inch)

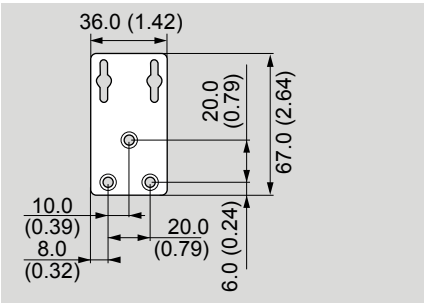

- For some applications, it may be more convenient to mount the OnCell G3150A-LTE to a wall:

- Remove the aluminum DIN-rail attachment plate from the OnCell G3150A-LTE
- Then attach the wall-mounting plates with M3 screws.

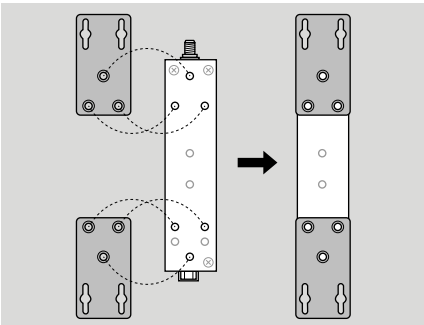

- Mounting the OnCell G3150A-LTE to a wall requires 4 screws.
- Use the OnCell G3150A-LTE device, with wall mount plates attached as a guide, to mark the correct locations of the 4 screws.
- The heads of the screws should be less than 6.0 mm in diameter, and the shafts should be less than 3.5 mm in diameter.

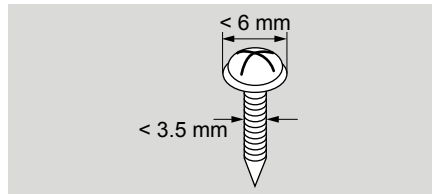

- Test the screw head and shank size by inserting the screws into one of the keyhole shaped apertures of the wall-mounting plates before attaching the plates to the wall.
- Once the screws are fixed into the wall, insert the four screw heads through the large opening of the keyhole-shaped apertures.
- Then slide the OnCell G3150A-LTE downwards.

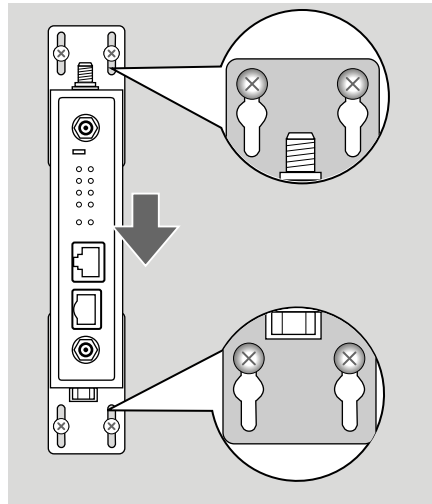

- Tighten the four screws for added stability.

## Wiring

### **⚠ WARNING**

#### **Safety First!**

Be sure to disconnect the power cord before installing and/or wiring your Moxa OnCell G3150A-LTE.

#### **EXPLOSION HAZARD!**

Do not disconnect equipment unless you have removed the power source to the equipment or the area is known to be non-hazardous.

- Use separate paths to route wiring for power and devices.
- If power wiring and device wiring paths must cross, make sure the wires are perpendicular at the intersection point.
- Do not run signal or communications wiring and power wiring in the same wire conduit. To avoid interference, wires with different signal characteristics should be routed separately.

- ▷ You can use the type of signal transmitted through a wire to determine which wires should be kept separate. The rule of thumb is that wiring with similar electrical characteristics can be bundled together.
- ▷ Keep input wiring and output wiring separate.
- ▷ It is strongly advised that you label wiring to all devices in the system when necessary.

## ! ATTENTION

- This product is intended to be supplied by a Listed Power Unit marked “Class 2” or “LPS” and rated O/P: 9.6 W (12 V/0.78 A to 48 V/0.2 A).
- Make sure that the external power adapter (includes power cords and plug assemblies) provided with the unit is certified and suitable for use in your country.
- Use the antennas correctly!  
Wide-band (2G/3G/4G) antennas are needed when the OnCell G3150A-LTE operates. Make sure that your antenna installation is within a safety area, which is covered by a lightning protection or surge arrest system.

## ⚠ WARNING

Do not locate the antenna near overhead power lines or other electric light or power circuits, or where it can come into contact with such circuits. When installing the antenna, take extreme care not to come into contact with such circuits, because they may cause serious injury or death when there is a surge. For instructions on proper installation and grounding of the antenna, refer to national and local codes (for example, U.S.: NFPA 70, National Electrical Code, Article 810, and Canada: Canadian Electrical Code, Section 54).

### Grounding the Moxa OnCell G3150A-LTE

- ▷ Grounding and wire routing help limit the effects of noise due to electromagnetic interference (EMI). Run the ground connection from the ground screw to the grounding surface prior to connecting devices.
- ▷ The minimum cross-sectional area of the grounding conductor should be equal to that of the input cable.

## ! ATTENTION

This product is intended to be mounted on a well-grounded mounting surface, such as a metal panel. The potential difference between the two ground potentials must be zero. If the potential difference is NOT zero, the product could be permanently damaged.

### Connecting the Power Input

- ▷ Input Terminal Block (J3) is suitable for 12-28 AWG (3.31-0.0804 mm<sup>2</sup>) wire size, torque value 4.5 lb-in (0.51 Nm).

### Pinouts for the Power Inputs and Relay Output

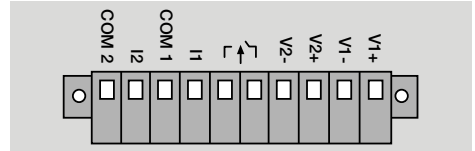

Pin	Name	Usage
1	V1+	DC Power Input 1
2	V1-	
3	V2+	DC Power Input 2
4	V2-	
5	Relay Output symbol	Relay Output
6		
7	I1	Digital Input
8	COM 1	Digital Input GND
9	I2	Digital Input
10	COM 2	Digital Input GND

### Wiring the Redundant Power Inputs

## ! ATTENTION

Before connecting the OnCell G3150A-LTE to the DC power inputs, make sure that the DC power source voltage is stable.

- ▷ The top two pairs of contacts of the 10-contact terminal block connector located on the top panel of the OnCell G3150A-LTE are used as the two DC inputs.

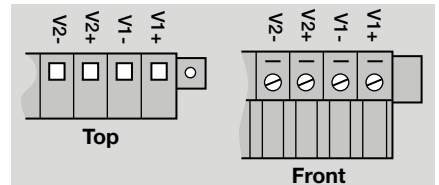

- 1 Insert the negative/positive DC wires into the V-/V+ terminals.
- 2 To keep the DC wires from pulling loose, use a small flat-blade screwdriver to tighten the wire-clamp screws on the front of the terminal block connector.
- 3 Insert the plastic terminal block connector prongs into the terminal block receptor, which is located on the top panel of the OnCell G3150A-LTE.

### Wiring the Relay Contact

- ▷ The OnCell G3150A-LTE has one relay output, which consists of the two contacts of the terminal block on the OnCell G3150A-LTE's top panel.
- ▷ For detailed electrical requirement, see page 7 (Specifications).

- ▷ The relay contacts are used to indicate user-configured events. The two wires attached to the relay contacts form an open circuit when a user-configured event is triggered. If a user-configured event does not occur, the relay circuit will be closed.

### Wiring the Digital Inputs

- ▷ The OnCell G3150A-LTE has two sets of digital inputs—DI1 and DI2.
- ▷ Each DI comprises of two contacts on the 6-pin terminal block connector located on the top panel of the OnCell G3150A-LTE.
- ▷ For detailed information on isolated digital input definition, see page 7 (Specifications).

### Communication Connections

#### 10/100BaseT(X) Ethernet Port Connection

- ▷ The 10/100BaseT(X) ports located on the front panel of the OnCell G3150A-LTE are used to connect to Ethernet-enabled devices.
- ▷ Pinouts for both MDI (NIC-type) ports and MDI-X (HUB/Switch-type) ports:

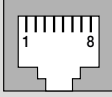
MDI Port Pinouts		MDI-X Port Pinouts		8-Pin RJ45
Pin	Signal	Pin	Signal	
1	Tx+	1	Rx+	
2	Tx-	2	Rx-	
3	Rx+	3	Tx+	
4	Rx-	6	Tx-	

#### Serial DB9 Connection

- ▷ The OnCell G3150A-LTE has one DB9 male port that supports RS-232, RS-485-4W, RS-485-2W, and RS-422:

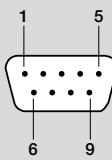
Pin assignments				DB9 Male Connector
Pin	RS-232	RS-422/485-4w	RS-485-2w	
1	DCD	TxD-(A)	-	
2	RxD	TxD+(B)	-	
3	TxD	RxD+(B)	Data+(B)	
4	DTR	RxD-(B)	Data-(A)	
5	GND	GND	GND	
6	DSR			
7	TRSR			
8	CTS			
9	-	-	Tx-	

#### RS-232 Console Connection

- ▷ The OnCell G3150A-LTE has one RS-232 (8-pin RJ45) console port located on the front panel.
- ▷ Use either an RJ45-to-DB9 or RJ45-to-DB25 cable to connect the Moxa OnCell G3150A-LTE's console port to your PC's COM port.
- ▷ You may then use a console terminal program to access the OnCell G3150A-LTE for configuring the console configuration.

#### Console Pinouts for 10-Pin or 8-Pin RJ45

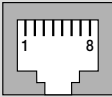
10-Pin	Description	8-Pin	
1	-		
2	DSR	1	
3	RTS	2	
4	GND	3	
5	TxD	4	
6	RxD	5	
7	-	6	
8	CTS	7	
9	DTR	8	
10	-		

- ▷ The pin numbers for both 8-pin and 10-pin RJ45 connectors (and ports) are typically not labeled on the connector (or port).

#### LED Indicators

- ▷ The front panel of the Moxa OnCell G3150A-LTE contains several LED indicators.

Function of LEDs				
Type	Color	State	Description	
Signal (1 LED)	Green	Blinking	The number of blinks indicates the cellular signal level (once the device is connected to a cellular network with an IP address.) Interval between two blinks: 200 ms Gap: 2 seconds	
			No. of Cellular Blinks	RSSI Range (dBm)
		1	0 < SNR ≤ 12	113 < RSSI ≤ -89
		2	12 < SNR ≤ 21	-89 < RSSI ≤ -73
		3	22 < SNR ≤ 31	-73 < RSSI ≤ -51
The Cellular RSSI value is based on the OnCell device signal strength returned by the AT+CSQ AT command. You can also refer to the equivalent signal RSSI Range (dBm) provided in the table above.				
PWR1/ PWR2	Green	On	DC power source active	
		Off	Power is off	
Ready	Green	On	System startup is complete and the system is in operation	
		Blinking (slow at 1-sec intervals)	The OnCell device has been located by the Wireless Search Utility.	
		Off	Power is off, or device is booting up.	
Fault	Red	On	Device is booting up, or IP address conflict.	
		Blinking (slow at 1-sec intervals)	Cannot get an IP address from the DHCP server	
		Off	Power is off or no error condition exists.	

Function of LEDs			
Type	Color	State	Description
2G/3G	Amber	Blinking (slow at 500-ms intervals)	GSM/GPRS/EDGE is connected.
		On	UMTS/HSPA is connected.
		Off	GSM/GPRS/EDGE/UMTS/HSPA is disconnected.
4G	Amber	On	LTE is connected
SIM1	Amber	Off	LTE is disconnected.
		On/Off	SIM 1 is active or inactive
SIM2	Amber	Blinking	SIM 1 is not inserted or PIN code is incorrect
		On/Off	SIM 2 is active or inactive
GPS	Green	On	GPS signal has been located
		Blinking	Locating GPS signal or less than four satellites have been located.
		Off	GPS signal has not been located
TX Rx	Amber	On	The serial port is transmitting data
		Off	No data is being transmitted or received through the serial port

## Specifications

### Cellular Specification

Standards: GSM/GPRS/EDGE/UMTS/HSPA/LTE.

Band Options:

OnCell G3150A-LTE-EU:

B1 (2100 MHz)/B3 (1800 MHz)/B7 (2600 MHz)/B8 (900 MHz)/B20 (800 MHz),

UMTS/HSPA 2100/1900/850/800/900 MHz,

OnCell G3150A-LTE-US:

B2 (1900 MHz)/B4 (AWS)/B5 (850 MHz)/ B13 (700 MHz)/B17 (700 MHz)/B25 (1900 MHz),

UMTS/HSPA 2100/1900/AWS/850/900 MHz,

Universal quad-band GSM/GPRS/EDGE/1800/1900 MHz.

LTE Data Rate:

Category 3 Downlink: 100 Mbps (20 MHz bandwidth), 50 Mbps (10 MHz bandwidth) Uplink: 50 Mbps (20 MHz bandwidth), 25 Mbps (10 MHz bandwidth).

HSPA Data Rate:

Downlink: Up to 42 Mbps (category 24) Uplink: Up to 5.76 Mbps (category 6).

GPRS Data Rate:

Downlink/Uplink: 85.6 kbps DL, 42.8 kbps UL.

### Interface

Cellular Antenna Connectors:

2 SMA (female), MIMO for LTE, antenna diversity for WCDMA.

SIM Slots: Dual SIM card support, full-sized SIM (1FF).

GNSS:

1 SMA (female), GPS: 1575.42 MHz, GLONASS: 1602 MHz.

Ethernet:

1, 10/100 Mbps auto negotiation speed, F/H duplex mode and auto MDI/MDI-X connection (RJ45-type).

Serial Console Port:

1, RS-232 (RJ45-type).

Serial Port:

1, RS-232, RS-485-4W , RS-485-2W, RS-422 (DB9 male).

Serial Communication Parameters:

Data Bits: 5,6,7,8,

Stop Bits: 1,1.5, 2 (when parity = None),

Parity: None, Even, Odd, Space, Mark,

Baudrate: 75 bps to 921.6 kbps.

LED Indicators:

PWR1, PWR2, READY, FAULT, CELLULAR SIGNAL, SIM1, SIM2, 2G/3G, 4G, GPS, TX/RX.

Alarm Contact: 1 relay output with current carrying capacity of 1 A @ 24 VDC.

Digital Inputs:

2 electrically isolated inputs:

+13 to +30 V for state "1",

+3 to -30 V for state "0",

Max. input current: 8 mA.

Ground Screw: M5.

Reset Button: Power reset/factory default reset.

### Software Specification

Network Protocol:

ICMP, TCP/IP, UDP, DHCP, Telnet, DNS, SNMP, HTTP, HTTPS, SMTP, SNTP, ARP.

Routing/Firewall:

NAT, port forwarding, IP/MAC/port filtering.

VPN:

Max. Tunnel Number: 5 (Responder/Initiator)

IPsec (DES, 3DES, AES, MD5, SHA-1, DH2, DH5),

PSK/X.509/RSA,

GRE over IPsec,

Open VPN,

NAT-T, PFS, DPD.

Management Options:

Remote SMS Control, SNMPv1/v2c/v3, Web/Telnet/

Serial Console.

Others: DDNS.

### Software Specifications (Moxa Proprietary)

GuaranLink: Dual SIM 4-tiers heart-beat for reliable and persistent cellular connectivity.

OnCell Central Manager: Large scale centralized device management over private cellular IP addresses.

Search Utility:

Simple device configuration and management utility.

### Physical Characteristics

Housing: Aluminum, providing IP30 protection.

Mounting:

DIN rail (default) or wall mount (optional).

Input Terminal Block (J3):

Suitable for 12-28 AWG (3.31-0.0804 mm<sup>2</sup>) wire size, torque value 4.5 lb-in (0.51 Nm). The minimum cross-sectional area of the grounding conductor should be equal to that of the input cable.

Weight: 492 g (1.08 lb).

Dimensions:

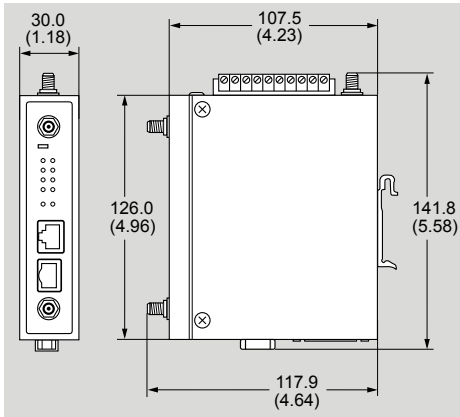

Installation:

DIN-rail mounting, wall mounting (with optional kit).

### Environmental Limits

Operating Temperature:

Standard Models: 0 to 55°C (32 to 131°F),

Wide Temp. Models: -30 to 70°C (-22 to 158°F).

Storage Temperature: -40 to 85°C (-40 to 185°F).

Ambient Relative Humidity:

5 to 95% (30°C, non-condensing).

### Power Requirements

Input Voltage:

12 to 48 VDC, redundant dual DC power inputs.

Connector: 4-pin removable terminal block.

Power Consumption:

9.6 W (12 V/0.78 A to 48 V/0.2 A).

Reverse Polarity Protection: Present.

### Reliability

MTBF: > 528,596 hours.

## Standards and Certifications

### Safety

OnCell G3150A-LTE-US: UL 60950-1.

### EMI

OnCell G3150A-LTE-US: FCC Part 15 Subpart B.

### EMS

OnCell G3150A-LTE-EU: EN 61000-6-2/-4.

## For More Information

The Honeywell Thermal Solutions family of products includes Honeywell Combustion Safety, Eclipse, Exothermics, Hauck, Kromschroder and Maxon. To learn more about our products, visit [www.ThermalSolutions.honeywell.com](http://www.ThermalSolutions.honeywell.com) or contact your Honeywell Sales Engineer.

Elster GmbH  
Strothweg 1, D-49504 Lotte  
T +49 541 1214-0  
[hts.lotte@honeywell.com](mailto:hts.lotte@honeywell.com), [www.kromschroeder.de](http://www.kromschroeder.de)

Elster is part of Honeywell

**Honeywell Thermal Solutions – Support Line**

T ++1 888-516-9282  
[thermalqsupport@honeywell.com](mailto:thermalqsupport@honeywell.com)

### Radio

OnCell G3150A-LTE-US:

FCC ID N7NMC7355,

OnCell G3150A-LTE-EU:

EN 301 489-1, EN 301 489-7, EN 301 511/4.

### ATEX Zone 2 Certification Information

Demko 16 ATEX 1812X,

II 3 G Ex nA IIC T5 Gc,

Ambient Range:

-30°C ≤ Tamb ≤ +70°C.

IECEX UL 16.0166X

### Hazardous Location Standards

EN 60079-0:2012+A11:2013 / IEC 60079-0

6th Edition,

EN 60079-15: 2010 / IEC 60079-15 4th Edition.

## ! ATTENTION

This device complies with part 15 of the FCC Rules.

Operation is subject to the following two conditions:

1. This device may not cause harmful interference
2. This device must accept any interference received, including interference that may cause undesired operation.

## Warranty

Warranty Period: 5 years.

Details:

See [www.moxa.com/support/warranty.aspx](http://www.moxa.com/support/warranty.aspx).