

# Protective system control FCU 500 Furnace zone control FCU 505

## OPERATING INSTRUCTIONS

Cert. Version 02.19 · Edition 04.24 · EN · 03251016



### 1 SAFETY

#### 1.1 Please read and keep in a safe place



Please read through these instructions carefully before installing or operating. Following the installation, pass the instructions on to the operator. This unit must be installed and commissioned in accordance with the regulations and standards in force. These instructions can also be found at [www.docuthek.com](http://www.docuthek.com).

#### 1.2 Explanation of symbols

**1, 2, 3, a, b, c** = Action

→ = Instruction

#### 1.3 Liability

We will not be held liable for damage resulting from non-observance of the instructions and non-compliant use.

#### 1.4 Safety instructions

Information that is relevant for safety is indicated in the instructions as follows:

#### **⚠ DANGER**

Indicates potentially fatal situations.

#### **⚠ WARNING**

Indicates possible danger to life and limb.

#### **⚠ CAUTION**

Indicates possible material damage.

All interventions may only be carried out by qualified gas technicians. Electrical interventions may only be carried out by qualified electricians.

#### 1.5 Conversion, spare parts

All technical changes are prohibited. Only use OEM spare parts.

### CONTENTS

1 Safety . . . . .	1
2 Checking the usage . . . . .	2
3 Installation . . . . .	2
4 Replacing the protective system/furnace zone control. . . . .	2
5 Cable selection. . . . .	3
6 Wiring. . . . .	4
7 Connection diagram . . . . .	6
8 Adjustment. . . . .	12
9 Commissioning . . . . .	13
10 Manual mode . . . . .	13
11 Assistance in the event of malfunction . . . . .	14
12 Parameters and values. . . . .	21
13 Legend . . . . .	23
14 Technical data . . . . .	23
15 Designed lifetime . . . . .	24
16 Logistics . . . . .	24
17 Accessories . . . . .	25
18 Certification . . . . .	25
19 Disposal . . . . .	26

## 2 CHECKING THE USAGE

The protective system control FCU 500 and furnace zone control FCU 505 are designed for the monitoring and controlling of central safety functions in multiple burner systems on an industrial furnace. The FCU 500 controls multiple zones acting as the central protective system control. The FCU 505 is used for protective system and capacity control in individual furnace zones.

This function is only guaranteed when used within the specified limits – see page 23 (14 Technical data). Any other use is considered as non-compliant.

### 2.1 Type code

<b>FCU</b>	Protective system control
<b>500</b>	Series 500
<b>Q</b>	Mains voltage: 120 V AC, 50/60 Hz
<b>W</b>	Mains voltage: 230 V AC, 50/60 Hz
<b>C0</b>	No valve proving system
<b>C1</b>	Valve proving system
<b>F0</b>	No capacity control
<b>F1</b>	Modulating with IC interface
<b>F2</b>	Modulating with RBW interface
<b>H0</b>	No temperature monitoring
<b>H1</b>	With temperature monitoring
<b>K0</b>	No connection plugs
<b>K1</b>	Connection plugs with screw terminals
<b>K2</b>	Connection plugs with spring force terminals
<b>-E</b>	Individual packaging

### 2.2 Part designations

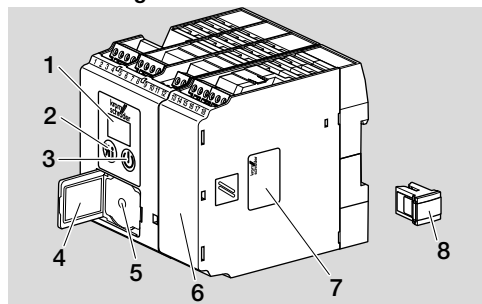

- 1 LED display for program status and fault messages
- 2 Reset/Information button
- 3 On/Off button
- 4 Type label
- 5 Connection for opto-adapter
- 6 Power module, replaceable
- 7 Power module type label
- 8 Parameter chip card, replaceable

Type designation (FCU...), construction stage, input voltage – see type label

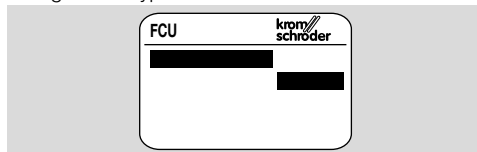

## 3 INSTALLATION

### ⚠ CAUTION

Please observe the following to ensure that the FCU is not damaged:

- Dropping the device can cause permanent damage. In this event, replace the entire device and associated modules.

→ Installation position: vertically upright, horizontal or tilted to the left or right.

→ The FCU mounting is designed for horizontally aligned 35 × 7.5 mm DIN rails.



→ If the DIN rail is aligned vertically, end clamps are required (e.g. Clipfix 35 by Phoenix Contact) to prevent the FCU from slipping.

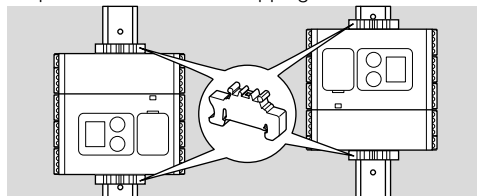

→ Install in a clean environment (e.g. a control cabinet) with an enclosure ≥ IP 54, whereby no condensation is permitted.

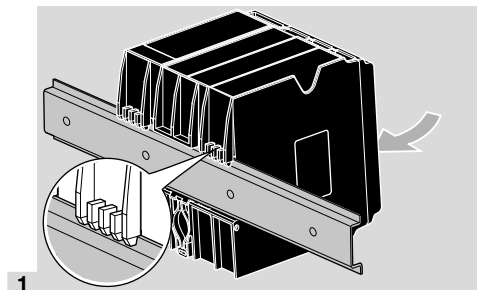

## 4 REPLACING THE PROTECTIVE SYSTEM/FURNACE ZONE CONTROL

1 Disconnect the system from the electrical power supply.

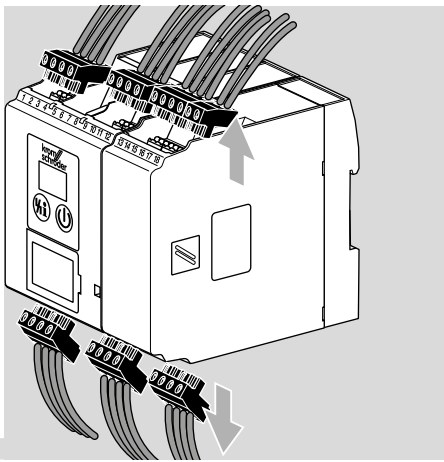

2

3 Disengage the FCU from the DIN rail.

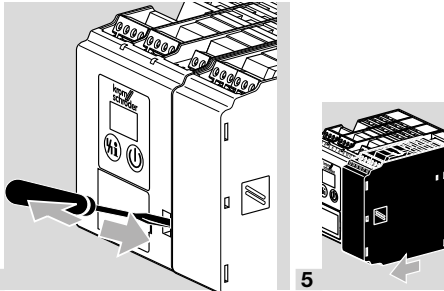

4

6 Transfer the parameter values from the old FCU to the new FCU.

→ Remove the parameter chip card from the old FCU and insert into the new FCU.

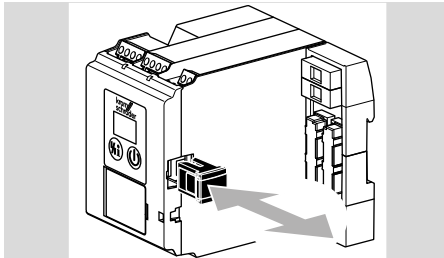

→

All the parameter settings of the FCU are saved on the parameter chip card.

## ⚠ CAUTION

### Malfunction (fault message bc)!

The old and new FCUs must have the same hardware configuration (see type designation on type label). The parameter chip card is not backward compatible. If the parameter chip card has been operated in an FCU with more recent firmware, it cannot be used in a device with older firmware.

→ Alternatively, the parameters values can be read from the old FCU and then read back into the new FCU using the separate BCSofT software,

see page 12 (8 Adjustment) and page 25 (17 Accessories).

7 Slide the power module back on.

8 Mount the FCU 5xx on the DIN rail again.

9 Reconnect the connection terminals.

10 Switch the system on again, see page 13 (9 Commissioning).

→ Fault message bc: Parameter chip card from an FCU 5xx of construction stage B or above has been inserted into an FCU 5xx of construction stage A, see also page 14 (11 Assistance in the event of malfunction).

## 5 CABLE SELECTION

→ Signal and control line for screw terminals max. 2.5 mm<sup>2</sup> (min. AWG 24, max. AWG 12), for spring force terminals max. 1.5 mm<sup>2</sup> (min. AWG 24, max. AWG 12).

→ Do not route FCU cables in the same cable duct as frequency converter cables or cables emitting strong fields.

→ The control lines must be selected in accordance with local/national regulations.

→ External electrical interference must be avoided.

### Ionization cable, UV cable

→ Cable lengths of 100 m are acceptable if there is no EMC interference.

→ The flame signal is adversely affected by EMC influences.

→ Lay cables individually (with low capacitance) and, if possible, not in a metal conduit.

## 6 WIRING

- Do not reverse phase L1 and neutral conductor N.
- Do not install different phases of a three-phase current system at the inputs.
- Do not connect voltage to the outputs.
- A short-circuit on the outputs causes one of the replaceable fuses to trip.
- Ensure that the inputs at terminals 1 to 4 and 44 are only supplied with 24 V DC.
- 24 V DC power supply: + at terminal 62, - at terminal 61.
- Ensure that the 24 V DC outputs at terminals 41 and 42 are not connected to mains voltage.
- Do not set the remote reset so that it operates automatically in cycles.
- Wire the safety circuit inputs via contacts (relay contacts) only.
- The unit features an output for fan control (terminal 58). This single-pole contact can be loaded with a max. of 3 A. The max. start-up current of the fan motor must not exceed a value of max. 6 A for 1 s – use an external contactor if required.
- The limiters in the safety interlock (linking of all the relevant safety-related control and switching equipment for the use of the application, for example, safety temperature limiter) must isolate terminal 46 from the voltage supply. If the safety interlock is interrupted, the display shows a blinking **50** as a warning signal and all of the FCU's control outputs are disconnected from the electrical power supply.
- Connected control elements must be equipped with protective circuits in accordance with the manufacturer's instructions. The protective circuit prevents high voltage peaks which can cause malfunctioning of the FCU.
- Functions of terminals 51, 65, 66, 67 and 68 are dependent on parameter values:

Terminal	Dependent on parameter
51	69
65	70
66	71
67	72
68	73

- 1** Disconnect the system from the electrical power supply.
  - 2** Before wiring the FCU, ensure that the yellow parameter chip card has been inserted in the FCU.
- Screw terminals or spring force terminals are available for the FCU:  
Screw terminal, Order No.: 74923998.  
Spring force terminal, Order No.: 74924000.
- 3** Wire as shown on the connection diagram – see page 6 (7 Connection diagram).

- Ensure a good PE (ground) wire connection to the burner control units and burners.
- Ensure that a clean sinusoidal voltage is applied to the FCU so as to avoid mains voltage errors due to irregularities in the mains voltage.

### FCU..H1

- Use Type K NiCr-Ni, Type N NiCrSi-NiSi or Type S Pt10Rh-Pt Class 1 double thermocouples only.

Thermocouple	Temperature range (°C)
Type K NiCr-Ni	-40 to 1000
Type N NiCrSi-NiSi	-40 to 1000
Type S Pt10Rh-Pt	0 to 1600

- Parameter 22 = 1: Type K double thermocouple NiCr-Ni
- Parameter 22 = 2: Type N double thermocouple NiCrSi-NiSi
- Parameter 22 = 3: Type S double thermocouple Pt10Rh-Pt
- STM:  
Parameter 20 = 1: High temperature operation with STM. Position the double thermocouple at the coldest point in the furnace so that it can reliably detect whether the spontaneous ignition temperature (> 750°C) has been exceeded.
- STL:  
Parameter 20 = 2: Maximum temperature monitoring using STL. Position the double thermocouple at the warmest point in the furnace so that it can reliably detect whether the maximum permitted temperature has been exceeded.
- STL and STM:  
Parameter 20 = 3: High temperature operation with STM and maximum temperature monitoring with STL. Position the double thermocouple in the furnace in such a way that it can reliably detect whether the spontaneous ignition temperature (> 750°C) has been exceeded and also whether the maximum permitted furnace temperature has been exceeded.

### FCU..C1

- Parameter 51 = 1: Tightness test before furnace start-up.
- Parameter 51 = 2: On; tightness test after furnace shut-down, after a fault lock-out or after mains on.
- Parameter 51 = 3: On; tightness test before furnace start-up and after furnace shut-down.
- Parameter 51 = 4: Permanent via proof of closure function (POC).

### Safety interlock output in the case of higher power requirement

- The burner start enable signal is issued to the connected burner control units or automatic burner control units via the safety interlock output (terminal 57).

- For burner control units or automatic burner control units whose safety interlock input has a current consumption of  $\leq 2$  mA, the power (max. 0.5 A,  $\cos \phi = 1$ ) of the FCU is sufficient to directly activate them.
- In the event that a higher output current is required, the output current can be increased by means of a contact multiplier using two contactors. Design the circuit as follows:

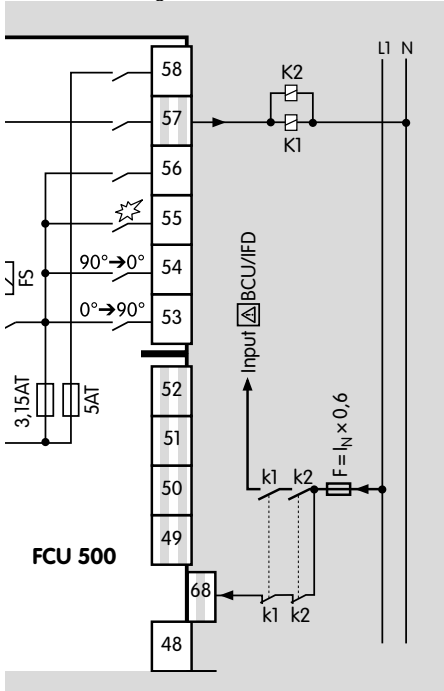

contactors. Design the circuit as follows:

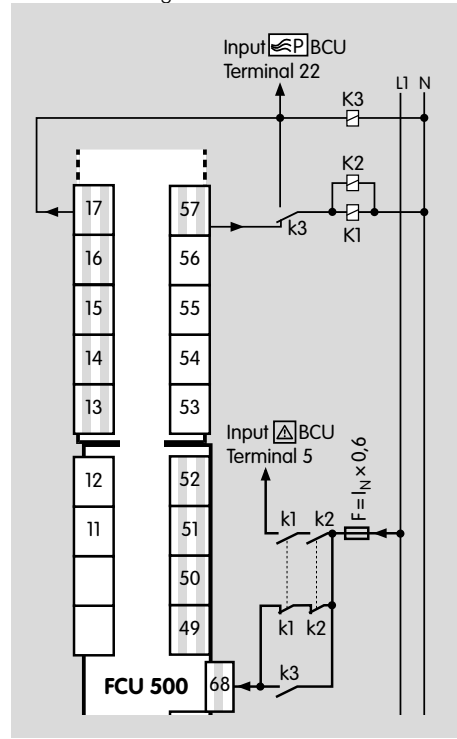

- BCU with power supply for valves and ignition transformer via safety interlocks (terminal 5)

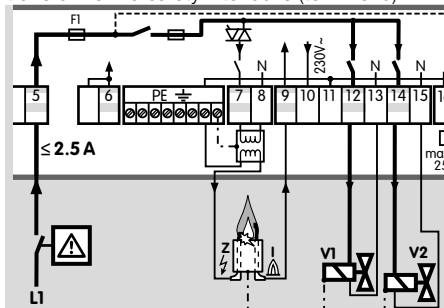

- In the event that a higher output current is required, the output current can be increased by means of a contact multiplier using three

# 7 CONNECTION DIAGRAM

## 7.1 FCU 500

→ Legend – see page 23 (13 Legend).

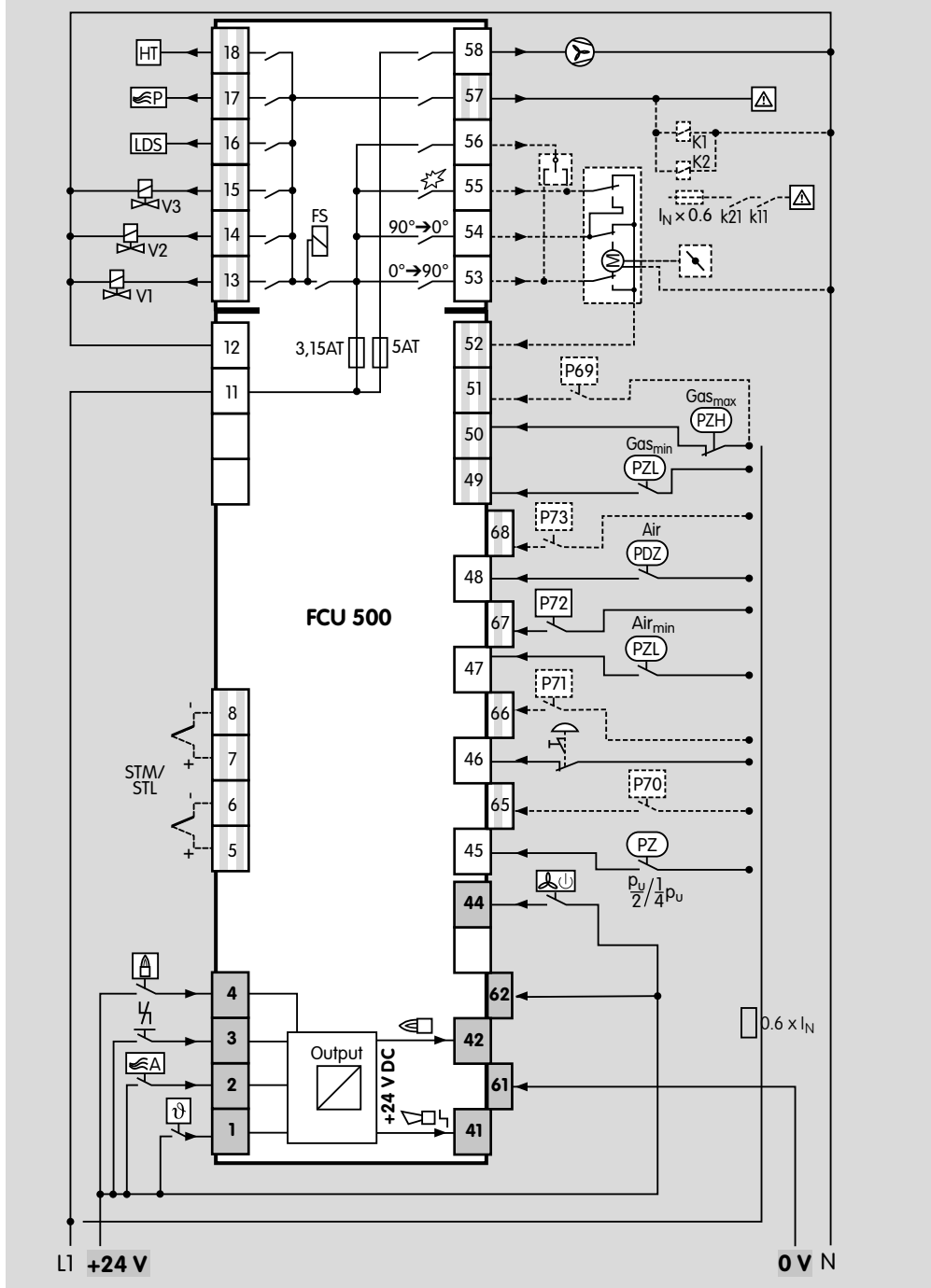

## 7.2 FCU 505

→ Legend – see page 23 (13 Legend).

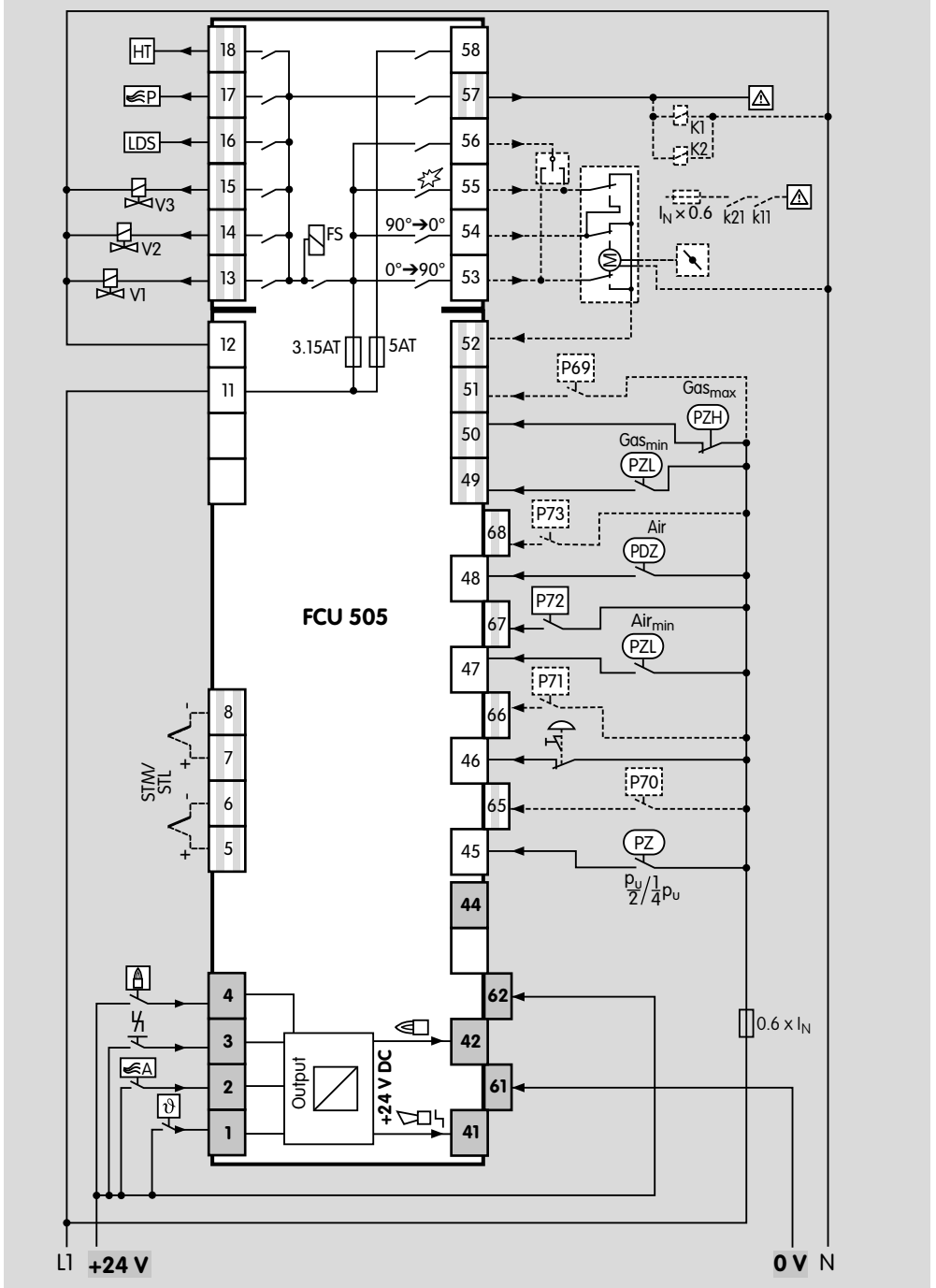

### 7.3 IC 20 connected to FCU..F1

→ Continuous control via three-point step controller.

→ Parameter 40 = 1.

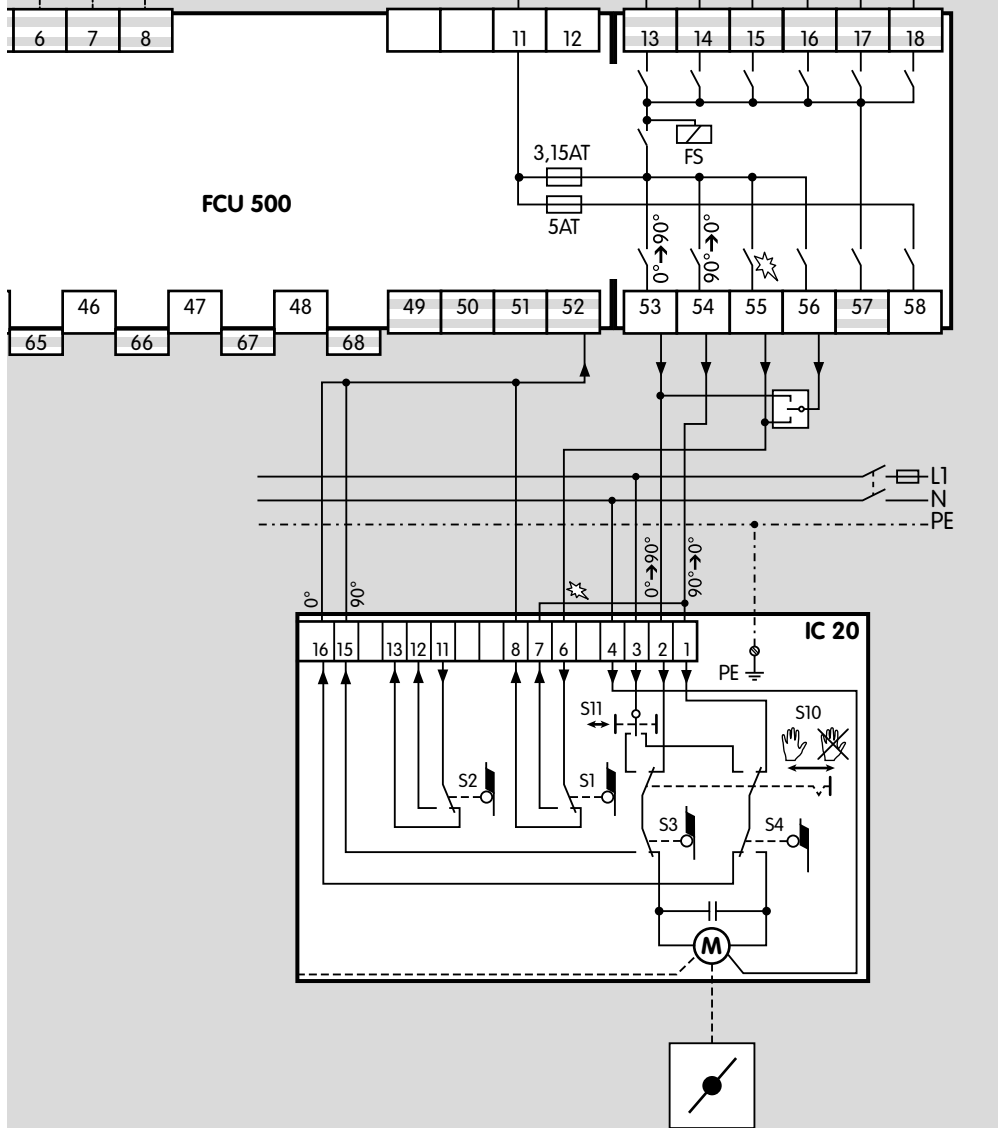



### 7.4 IC 20 E connected to FCU..F1

→ Continuous control via analogue input.

→ Parameter 40 = 1.

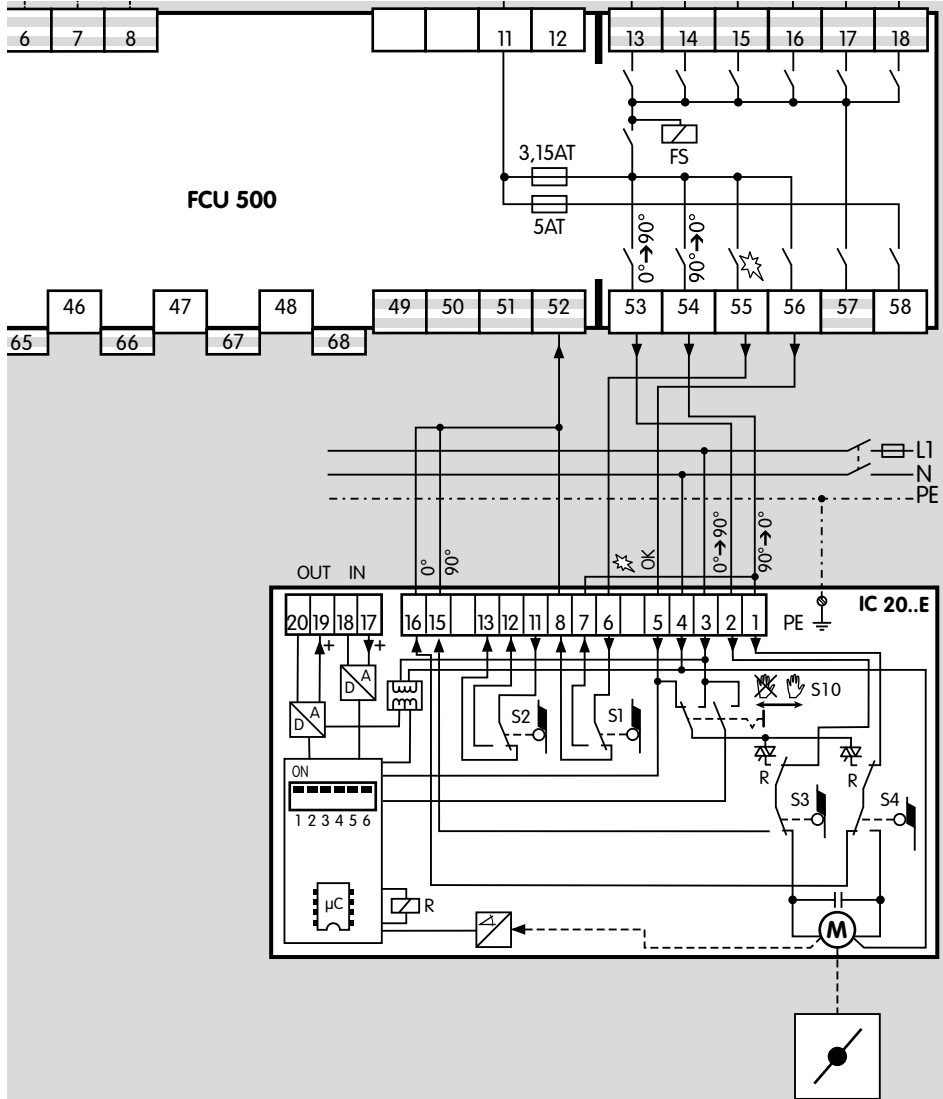

**7.5 IC 40 connected to FCU..F1**

- Parameter 40 = 2.
- Continuous control via analogue input.

→ Set IC 40 to operating mode 27, see operating instructions "Actuators IC 20, IC 40, IC 40S".

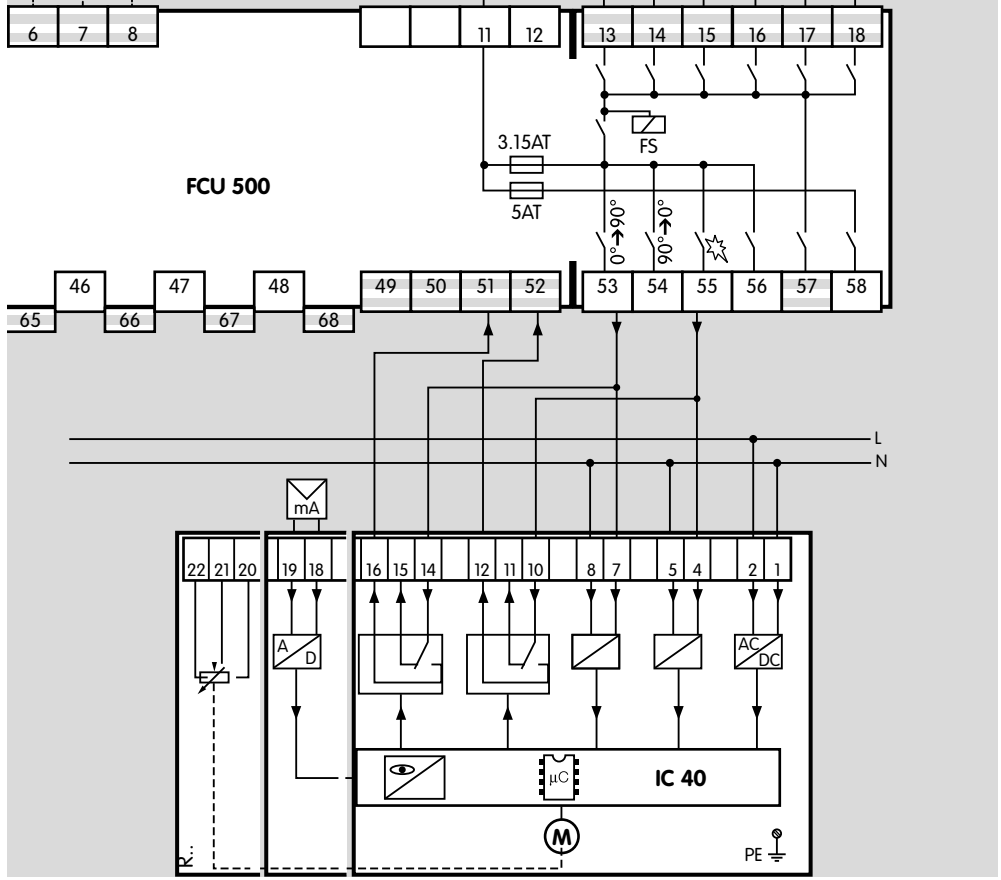

## 7.6 RBW valve connected to FCU..F2

→ Parameter 40 = 3.

### Continuous control via three-point step controller

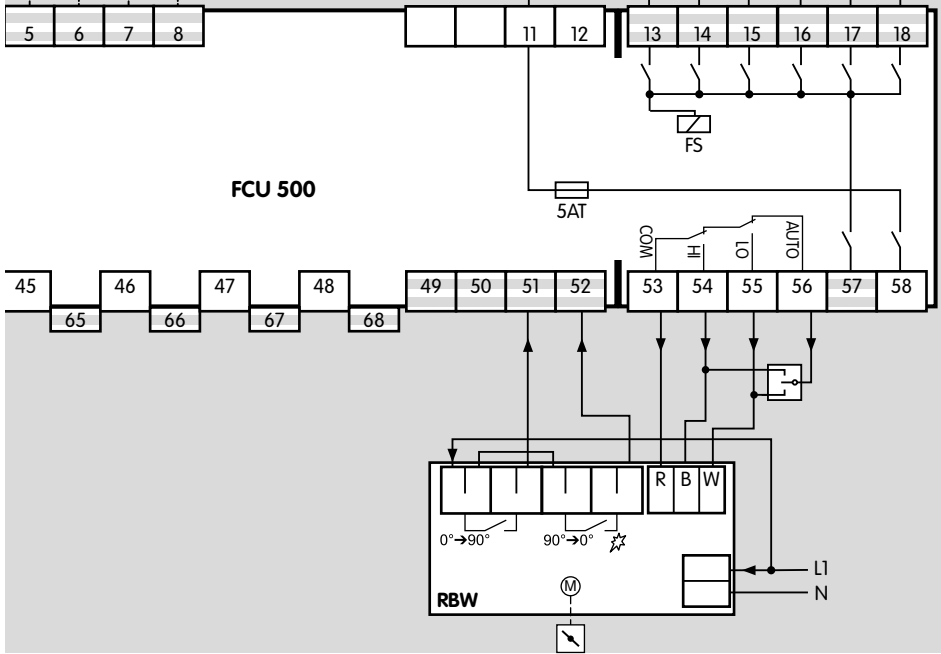

### Continuous control via analogue input

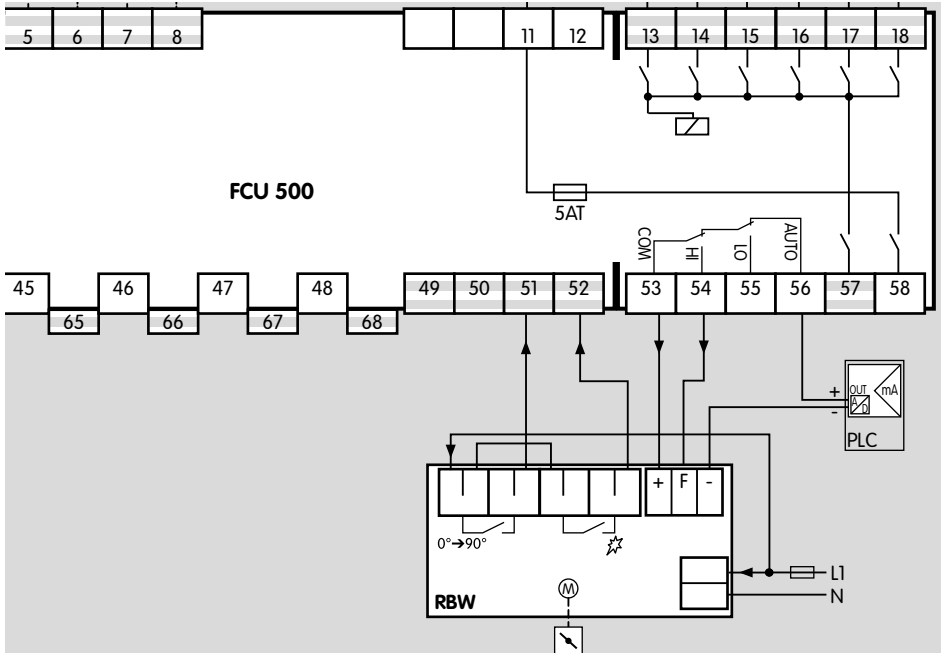

## 7.7 Frequency converter connected to FCU..F2

→ Continuous control via speed-controlled fan.

→ Parameter 40 = 4.

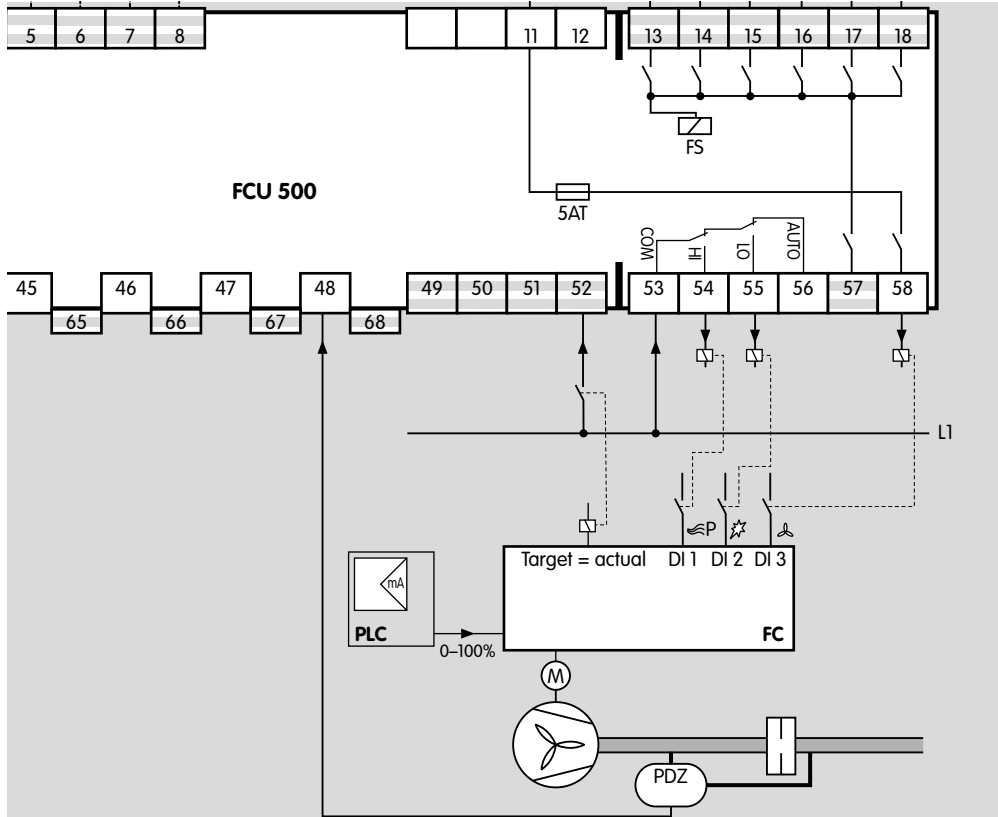

## 8 ADJUSTMENT

In certain cases, it may be necessary to change the parameters set at the factory. The parameters on the FCU, such as the pre-purge time or the behaviour in the event of a flame failure, can be modified using the separate BCSOFT software package and an opto-adapter.

- The software package and the opto-adapter are available as accessories.
- Changed parameters are saved on the integrated parameter chip card.
- The factory settings are secured with a programmable password.
- If the password has been changed, the end customer can look up the changed password in the plant documentation or ask the system supplier.

## 9 COMMISSIONING

→ During operation, the 7-segment display shows the program status:

00	Start-up position/Standby
H0	Switch-on delay/min. pause time
H1	Waiting for purge signal from furnace FCU
H2	Waiting for start enable
Rc	Approaching minimum capacity
d 0	"No flow" state check on fan
01	Fan run-up time $t_{GV}$
R0	Approaching maximum capacity
d 1	Low air pressure protection check
P1	Pre-purge
R1	Approaching ignition capacity
tc	Valve check
H7	Controller enable switch-on delay
H8	Waiting for burner operating signal
08	Operation/controller enable
P9	Post-purge
1	Controlled air flow
U	Remote control (with OCU)
[ ]	Data transfer (programming mode)
XX	High temperature operation
00 (blinking dots)	Manual mode
--	Device Off

### WARNING

Risk of explosion!

Check the system for tightness before commissioning.

Do not start the FCU until you are certain that the wiring is correct, the parameters have been set correctly and all input and output signals are being processed perfectly by means of conducting a function check and reading the parameters on the device.

**1** Switch on the system.

→ The display indicates --.

**2** Switch on the FCU by pressing the On/Off button.

→ The display indicates 00.

→ If the display blinks (fault), reset the FCU by pressing the Reset/Information button.

**3** Apply the start-up signal to terminal 1.

→ The display indicates H0. The safety interlocks are checked during the switch-on delay time/min. pause time.

→ The display indicates 01. The fan starts.

→ The display indicates d 1. The low air pressure protection check starts.

→ The display indicates P1. Pre-purge starts.

→ FCU..C1: The valve check runs in parallel to pre-purge. If the valve check lasts longer than pre-purge, the display indicates tc.

→ The display indicates H7. After pre-purge (and the end of the valve check on FCU..C1), the valves in the gas inlet section are opened.

→ The display indicates 08. The FCU issues the enable signal to the burner control units to start the burners.

### 9.1 High temperature operation

The FCU..H1 is fitted with an integrated temperature module for high temperature operation. As soon as the FCU has received the signal from the connected double thermocouples that the temperature defined in parameter 24 has been reached, a signal is sent to the high temperature inputs of the burner control units by the output at terminal 18. If voltage is applied to the high temperature inputs, the burner flames will no longer be monitored by the burner control units.

### WARNING

Risk of explosion!

High temperature operation is only permitted if the temperature in the furnace chamber is so high that the gas/air mixture is reliably combusted.

In countries where EN 746/NFPA 86 is applicable, if the furnace wall temperature is greater than or equal to 750°C (1400°F), the flame may be monitored by a fail-safe temperature monitoring device that complies with the standard.

Only if the temperature is greater than or equal to 750°C (1400°F) may voltage be applied to the high temperature inputs of the burner control units.

– Comply with the local safety regulations.

→ In high temperature mode, the two dots in the display are lit permanently.

→ The flame control system is placed out of operation.

→ Once the furnace temperature falls below the value defined in parameter 24, terminal 18 is isolated from the voltage supply. The burner control units continue operating with flame control, depending on their setting.

## 10 MANUAL MODE

→ For adjustment of the furnace system or for fault-finding.

→ In Manual mode, the FCU operates independently of the status of the inputs for start-up signal (terminal 1), controlled air flow (terminal 2) and remote reset (terminal 3). The function of the controller enable/emergency stop input (terminal 46) is retained.

→ Manual mode is terminated by switching off the FCU or in the event of a power failure.

→ Parameter 67 = 0: Manual mode unlimited in time. The furnace may continue to be operated manually in the event of failure of the control system or the bus.

- Parameter 67 = 1: The FCU will terminate Manual mode 5 minutes after the last time the Reset/Information button is pressed. It switches to the start-up position/standby (display  $\mathcal{00}$ ).
- 1** Switch on the FCU while holding the Reset/Information button. Hold the Reset/Information button until the two dots in the display start to blink.
- If the Reset/Information button is pressed, the current step in Manual mode is shown. After the button has been held for 1 second, the next step will be shown. The FCU now executes its program sequence until the display indicates  $\mathcal{08}$ .

### FCU..F1 with IC 20

- Following controller enable (display  $\mathcal{08}$ ), actuator IC 20 can be opened and closed as required.
- 2** Press the Reset/Information button.
- If the button continues to be held down, the actuator opens further until maximum capacity has been reached.
- The display indicates  $\mathcal{R.i}$ , with blinking dots.
- Once the button has been released, the butterfly valve stops in the relevant position.
- 3** Press the Reset/Information button again.
- If the button continues to be held down, the actuator closes further until minimum capacity has been reached.
- The display indicates  $\mathcal{R.U}$ , with blinking dots.
- A change of direction takes place each time the button is released and pressed again. When the butterfly valve has reached its final position, the dots disappear.

### FCU..F1 with IC 40, FCU..F2 with RBW or frequency converter

- Following controller enable (status display  $\mathcal{08}$ ), it is possible to approach binary positions between minimum and maximum capacity.

## 11 ASSISTANCE IN THE EVENT OF MALFUNCTION

### DANGER

Electric shocks can be fatal!

Before working on possible live components, ensure the unit is disconnected from the power supply.

Fault-clearance must only be undertaken by authorized trained personnel.

- Faults may be cleared only using the measures described below.
- If the FCU does not respond even though all faults have been remedied: remove the unit and return it to the manufacturer for inspection.
- Internal device errors can only be acknowledged using the Reset/Information button on the FCU.
- In the event of a warning, the FCU can continue to be operated via the control inputs.

- If fault lock-out has been programmed, a fault must be acknowledged using the Reset/Information button.
- If safety shut-down has been programmed, no fault signal is sent via the fault signalling contact. As soon as the fault no longer exists, the fault message on the display disappears. Acknowledging the fault using the Reset/Information button is not necessary.

### ? Faults

- !** Cause
  - Remedy

### ? The 7-segment display does not light up.

- !** Mains voltage is not applied.
  - Check the wiring, apply mains voltage (see type label).



### ? The display blinks and indicates $\mathcal{10}$ .

- !** Actuation of the remote reset input is faulty.
- !** Too many remote resets. More than 5 resets have been conducted within the last 15 minutes, either automatically or manually.
- !** Consecutive fault caused by a previous fault whose actual cause has not been remedied.
  - Pay attention to previous fault messages.
  - Remedy cause.
- The cause will not be remedied by performing a reset every time a fault lock-out occurs.
  - Check whether remote reset complies with standards (EN 746 allows resetting only under supervision) and correct if necessary.
- The FCU may only be reset manually under supervision.
  - Press the Reset/Information button on the FCU.



### ? The display blinks and indicates $\mathcal{20}$ .

- !** Voltage is applied to the output at terminal 56.
  - Check the wiring and ensure that the voltage outputs and inputs have the same polarity and are not reversed.
- !** The unit has suffered an internal error in the power module.
  - Replace the power module.



**? The display blinks and indicates 21.**

**!** Inputs 51 and 52 are activated simultaneously.

- Check input 51.

→ Input 51 may only be activated if the valve is open.

- Check input 52.

→ Input 52 may only be activated if the valve is in the position for ignition capacity.



**? The display blinks and indicates 22.**

**!** Actuator IC 20 has been wired incorrectly.

- Check the wiring. Wire the outputs and inputs of connection terminals 52–55 as shown in the connection diagram – see page 8 (7.3 IC 20 connected to FCU..F1).

**!** The unit has suffered an internal error in the power module.

- Replace the power module.



**? The display blinks and indicates 23.**

**!** The butterfly valve position is not constantly signalled back to the FCU.

- Check the wiring and ensure that the position for max. capacity/ignition capacity/closed of the butterfly valve is constantly signalled back via terminal 52.



**? The display blinks and indicates 24.**

**!** Faulty activation via the bus. Requirements for “Open” and “Close” set simultaneously.

- Ensure that “Open” and “Close” are not activated simultaneously.



**? The display blinks and indicates 30 or 31.**

**!** Abnormal data change in the parameters set for the FCU.

- Reset the parameter to its original value using the BCSofT software.
- Establish the cause of the fault to avoid repeat faults.

- Ensure that the cables have been installed properly – see page 3 (5 Cable selection).
- If the measures described above do not help, remove the unit and return it to the manufacturer for inspection.



**? The display blinks and indicates 32.**

**!** Supply voltage too low or too high.

- Operate the FCU in the specified mains voltage range (mains voltage +10/-15%, 50/60 Hz).

**!** An internal device error occurred.

- Remove the unit and return it to the manufacturer for inspection.



**? The display blinks and indicates 33.**

**!** Faulty parameterization.

- Check parameter settings using BCSofT and adjust them if necessary.

**!** An internal device error occurred.

- Remove the unit and return it to the manufacturer for inspection.



**? The display blinks and indicates 36.**

**!** An internal device error occurred.

- Remove the unit and return it to the manufacturer for inspection.



**? The display blinks and indicates 37.**

**!** Faulty feedback from contactors.

- Check voltage supply to terminal 68 – see page 4 (6 Wiring).
- Check the setting of parameter 73.



**? The display blinks and indicates 38.**

**!** Interruption of signal at the “Fan feedback” input (terminal 44).

- Check voltage supply to terminal 44.
- Check the setting of parameter 31.



**? The display blinks and indicates 40.**

- ! The gas solenoid valve V1 is leaking.
  - Check the gas solenoid valve V1.
- ! The gas pressure switch DGp<sub>v</sub>/2 for the tightness test has been set incorrectly.
  - Check the inlet pressure.
  - Set DGp<sub>v</sub>/2 to the correct inlet pressure.
  - Check the wiring.
- ! The test pressure between V1 and V2 has not decreased.
  - Check the installation.
- ! The test period is too long.
  - Check parameter 56 (Measurement time for V<sub>p1</sub>) and change it using BCSof.
  - If the fault cannot be remedied by doing this, remove the unit and return it to the manufacturer for inspection.



**? The display blinks and indicates 41.**

- ! The downstream gas solenoid valve V2 or V3 is leaking.
  - Check the gas solenoid valves V2/V3.
- ! The gas pressure switch DGp<sub>v</sub>/2 (DGp<sub>v</sub>¾) for the tightness test has been set incorrectly.
  - Check the inlet pressure.
  - Set DGp<sub>v</sub>/2 (DGp<sub>v</sub>¾) to the correct pressure.
  - Check the wiring.
- ! The test period is too long.
  - Change parameter 56 (Measurement time) using BCSof.
  - If the fault cannot be remedied by doing this, remove the unit and return it to the manufacturer for inspection.



**? The display blinks and indicates 42.**

- ! Test volume V<sub>p2</sub> is leaking.
- ! The gas solenoid valve V3, one of the burner-side valves or the pipework is leaking.
  - Check the gas solenoid valves and pipework.
- ! The gas pressure switch DGp<sub>v</sub>/2 (DGp<sub>v</sub>¾) has been set incorrectly.
  - Check the inlet pressure.
  - Set DGp<sub>v</sub>/2 (DGp<sub>v</sub>¾) to the correct inlet pressure.
  - Check voltage supply to terminal 45 (65).
- ! The set test period V<sub>p1</sub> + V<sub>p2</sub> is too long.

- Change the test period using parameter 57.
- If the fault cannot be remedied by doing this, remove the unit and return it to the manufacturer for inspection.



**? The display blinks and indicates 44.**

- ! The FCU could not supply one of the test volumes (V<sub>p1</sub> or V<sub>p2</sub>).
- ! The FCU could not reduce the pressure of V<sub>p1</sub> or V<sub>p2</sub>.
- ! Faulty wiring of the activated valves.
  - Check valve actuation.
  - Faulty wiring of the pressure switches.
  - Check voltage supply to terminal 46 (65).



**? The display blinks and indicates 45.**

- ! Faulty valve actuation, reversed valve connection.
  - Check the wiring of the solenoid valves.



**? The display blinks and indicates 50.**

- ! Interruption of signal at the “Controller enable/ Emergency stop” input (terminal 46).
  - Check voltage supply to terminal 46.
  - Check the setting of parameter 10.



**? The display blinks and indicates 51.**

- ! Short-circuit on one of the outputs of the safety circuit.
  - Check the wiring.
  - Check fine-wire fuse F1 (3.15 A, slow-acting, H).
- The fine-wire fuse can be replaced once the power module has been removed, see page 20 (Replacing the fuse).
  - Then check the faultless processing of all input and output signals.
- ! The unit has suffered an internal error in the power module.
  - Replace the power module.





**? The display blinks and indicates 52.**

- !** The FCU is permanently reset by remote reset.
  - Check remote reset activation (terminal 3).
  - Apply signal to terminal 3 for approx. 1 second to reset only.



**? The display blinks and indicates 60.**

- !** The safety temperature limiter (STL) has detected an overtemperature condition.
  - Check the temperature control.
  - Check the wiring of terminals 5, 6, 7 and 8.

- !** The double thermocouple is defective.
  - Replace the double thermocouple.
  - If the fault cannot be remedied by doing this, remove the FCU and return it to the manufacturer for inspection.



**? The display blinks and indicates 62.**

- !** A cable discontinuity has been detected in the thermocouple at terminals 5 and 6.
  - Check the wiring of terminals 5 and 6.
  - Replace the double thermocouple.
  - If the fault cannot be remedied by doing this, remove the FCU and return it to the manufacturer for inspection.



**? The display blinks and indicates 63.**

- !** A cable discontinuity has been detected in the thermocouple at terminals 7 and 8.
  - Check the wiring of terminals 7 and 8.
  - Replace the double thermocouple.
  - If the fault cannot be remedied by doing this, remove the FCU and return it to the manufacturer for inspection.



**? The display blinks and indicates 64.**

- !** A malfunction (sensor short-circuit) has been detected in the thermocouple at terminals 5 and 6.
  - Check the wiring of terminals 5 and 6.
  - Replace the double thermocouple.

- If the fault cannot be remedied by doing this, remove the FCU and return it to the manufacturer for inspection.



**? The display blinks and indicates 65.**

- !** A malfunction (sensor short-circuit) has been detected in the thermocouple at terminals 7 and 8.
  - Check the wiring of terminals 7 and 8.
  - Replace the double thermocouple.
  - If the fault cannot be remedied by doing this, remove the FCU and return it to the manufacturer for inspection.



**? The display blinks and indicates 66.**

- !** Limit value of the temperature difference set via Parameter 23 between the thermocouples at terminals 5 and 6, and terminals 7 and 8 has been exceeded.
  - Check parameter 23 and adjust correctly.
  - Replace the double thermocouple.
  - If the fault cannot be remedied by doing this, remove the FCU and return it to the manufacturer for inspection.



**? The display blinks and indicates 67.**

- !** The thermocouples are being operated outside of the allowed temperature range.
  - Use Type K NiCr-Ni, Type N NiCrSi-NiSi or Type S Pt10Rh-Pt Class 1 double thermocouples:

Thermocouple	Temperature range (°C)
Type K NiCr-Ni	-40 to 1000
Type N NiCrSi-NiSi	-40 to 1000
Type S Pt10Rh-Pt	0 to 1600



**? The display blinks and indicates 70.**

- !** The connected burner control units have not signalled "Operating position reached (burner started)" within the time defined by parameter 47.
  - Check voltage supply to "Operating signal" input (terminal 4).
  - Check the setting of parameter 47.



**? The display blinks and indicates 72.**

**!** The connected burner control units are not ready for operation.

- Check voltage supply to terminal 67.
- Check the setting of parameter 72.



**? The display blinks and indicates 90.**

**!** Internal error in the temperature module.

- Short-circuit the two connected thermocouples.
- Press the Reset/Information button on the FCU.

**!** If the display continues to blink and indicate 90, the device has suffered an internal error.

- Remove the unit and return it to the manufacturer for inspection.

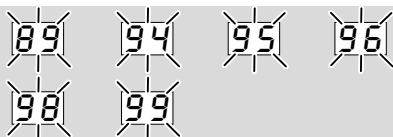

**? The display blinks and indicates 89, 94, 95, 96, 97, 98 or 99.**

**!** System fault – the FCU has performed a safety shut-down. The cause may be a unit defect or abnormal EMC influence.

- Ensure that the ignition cable has been installed properly – see page 3 (5 Cable selection).
- Ensure that the EMC regulations for the system are satisfied – particularly for systems with frequency converters – see page 3 (5 Cable selection).
- Reset the unit.
- Disconnect the FCU from the mains supply and then switch it on again.
- Check mains voltage and frequency.
- If the measures described above do not help, the unit has probably suffered a hardware defect – remove the unit and return it to the manufacturer for inspection.



**? The display blinks and indicates E d0.**

**!** The “no flow” state check of the air pressure switch has failed.

- Check the function of the air pressure switch.

→ Before the fan is switched on, there must be no High signal at the input for air monitoring (terminal 47) when air monitoring is activated.



**? The display blinks and indicates d 1.**

**!** The operating check of the air pressure switch has failed. The air monitor, depending on the parameter setting for input 47 or 48 (P15 and P35), has not switched after fan start-up.

- Check the air monitor wiring.
- Check the air pressure switch setpoint.
- Check the function of the fan.



**? The display blinks and indicates d P.**

**!** The input signal (terminal 48) from the air pressure switch has dropped out during pre-purge.

- Check the air supply during the purging process.
- Check the electrical wiring of the air pressure switch.
- Check voltage supply to terminal 48.
- Check the air pressure switch setpoint.



**? The display blinks and indicates d X.**

**!** The input signal (terminal 48) from the air pressure switch has dropped out during pre-purge.

- Check the air supply during the purging process.
- Check the electrical wiring of the air pressure switch.
- Check voltage supply to terminal 48.
- Check the air pressure switch setpoint.



**? The display blinks and indicates o X.**

**!** The signal for monitoring the max. gas pressure (terminal 50) has dropped out at position step X.

- Check the wiring.
- Check the gas pressure.



**? The display blinks and indicates u X.**

**!** The signal for monitoring the min. gas pressure (terminal 49) has dropped out at position step X.

- Check the wiring.
- Check the gas pressure.



**? The display blinks and indicates Ac.**

- !** No “Minimum capacity reached” signal from actuator.
- Check the butterfly valve and the function of the limit switches in the actuator.
  - Check the wiring.
  - Check the actuator.
  - If the fault cannot be remedied by doing this, remove the unit and return it to the manufacturer for inspection.



**? The display blinks and indicates Ao.**

- !** No “Maximum capacity reached” signal from actuator.
- Check the butterfly valve and the function of the limit switches in the actuator.
  - Check the wiring.
  - Check the actuator.
  - If the fault cannot be remedied by doing this, remove the unit and return it to the manufacturer for inspection.



**? The display blinks and indicates Ai.**

- !** No “Ignition capacity reached” signal from actuator.
- Check the butterfly valve and the function of the limit switches in the actuator.
  - Check the wiring.
  - Check the actuator.
  - If the fault cannot be remedied by doing this, remove the unit and return it to the manufacturer for inspection.



**? The display blinks and indicates b E.**

- !** Internal communication with bus module has suffered a fault.
- Check bus module connection.
  - Connected control elements must be equipped with protective circuits in accordance with the manufacturer’s instructions.
- This prevents high voltage peaks which can cause malfunctioning of the FCU.

- Use interference-suppressed terminal boots (1 kΩ).
- If the fault cannot be remedied by doing this, remove the unit and return it to the manufacturer for inspection.

- !** Bus module is defective.
- Replace the bus module.



**? The display blinks and indicates bc.**

- !** Incorrect or defective parameter chip card (PCC).
- Only the intended parameter chip card is to be used.
  - Replace defective parameter chip card.



**? The display blinks and indicates c l.**

- !** No input signal from the valve proof of closure switch (POC) during standby.
- Check the wiring.
- Mains voltage must be supplied to the FCU (terminal 45) if the valve is closed and no voltage is to be applied if the valve is open.
- Check that the proof of closure switch and valve function perfectly, replace defective valves.



**? The display blinks and indicates c B.**

- !** The FCU is receiving no information as to whether the POC switch contact is still open.
- Check the wiring.
  - Check parameterization of inputs at terminals 36, 37 and 38.
- During start-up, mains voltage must be supplied to the FCU (terminal 45) if the valve is closed and no voltage is to be applied if the valve is open.
- Check that the proof of closure switch and valve function perfectly, replace defective valves.



**? The display blinks and indicates n U.**

- !** No connection established between FCU and PLC.
- Check the wiring.
  - Check the PLC program to ensure that the network name and IP configuration of the FCU are valid.

- Switch on the PLC.



? **The display blinks and indicates n 1.**

→ Fault occurs on devices with fieldbus communication with address check (P80 = 1) only.

! An invalid or incorrect address has been set on the bus module.

- Assign the correct address (001 to FEF) to the bus module.



? **The display blinks and indicates n 2.**

! The bus module has received an incorrect configuration from the PLC.

- Check whether the correct GSD file was imported.



? **The display blinks and indicates n 3.**

! The device name for the FCU is invalid in the PLC program.

→ Device name on delivery:

**not-assigned-fcu-500-xxx**

( **xxx** = code switch setting on the FCU).

→ The device name must at least consist of the expression **fcu-500-xxx**.

- Check whether the code switch settings are identical to the entry ( **xxx**) in the PLC program.
- Delete the expression “ **not-assigned-**” in the PLC program or replace it with an individual name (e.g. Furnacezone1-).



? **The display blinks and indicates n 4.**

! PLC in STOP position.

- Check whether the PLC can be started.

## Replacing the fuse

→ The device fuses F1 and F2 can be removed for inspection.

1 Disconnect the system/ FCU from the electrical power supply.

2 Disconnect the connection terminals from the FCU.

→ The connection cables may remain screwed to the connection terminals.

3 Disconnect the power module, see page 2 (4 Replacing the protective system/furnace zone control).

4 Remove the fuse holder (with fine-wire fuse F1 or F2).

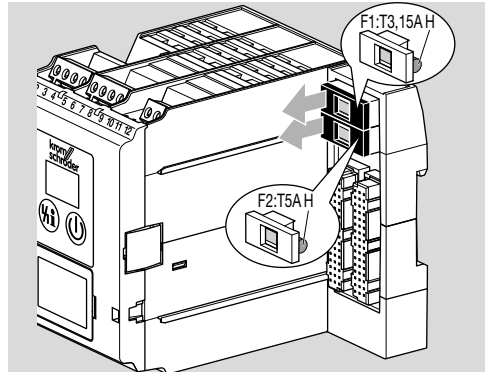

5 Check fine-wire fuse F1 or F2 for correct functioning.

6 Replace the fine-wire fuse if defective.

→ When replacing the fuse, use only the approved fuse type (F1: 3.15 A, slow-acting, H, F2: 5 A, slow-acting, H, pursuant to IEC 60127-2/5).

7 First reconnect the power module, then reconnect the connection terminals and restart the system/ FCU.

## 12 PARAMETERS AND VALUES

### 12.1 Scanning the parameters

- 1 Press the Reset/Information button for 2 s. The display changes to parameter 10.
  - 2 Release the button. The display stops at this parameter and indicates the related value.
  - 3 Press the button again for 2 s. The display changes to the next parameter.
- All parameters can be recalled one after the other in this way.
- If the button is pressed only briefly, the display indicates what parameter is currently being displayed.
- The normal program status is displayed again approx. 60 seconds after the last time the button is pressed.

### 12.2 For all FCU versions

Parameter	Name Value
10	Emergency stop 0 = Off 1 = With safety shut-down 2 = With fault lock-out
12	High gas pressure protection 0 = Off 1 = With safety shut-down 2 = With fault lock-out
13	Low gas pressure protection 0 = Off 1 = With safety shut-down 2 = With fault lock-out
15	Low air pressure protection 0 = Off 1 = With safety shut-down 2 = With fault lock-out
19	Safety time during operation 0; 1; 2 = Time in seconds
29	Fan in the event of fault 0 = Off 1 = On
30	Fan run-up time $t_{GV}$ 0-6000 = Time in seconds
31	Fan ready for operation 0 = Off 1 = With safety shut-down 2 = With fault lock-out
32	Air flow monitoring during controlled air flow 0 = Off; maximum capacity 1 = On; maximum capacity 2 = Off; controller enable
34	Pre-purge time $t_{PV}$ 0-6000 = Time in seconds
35	Air flow monitoring during pre-purge 0 = Off 1 = With safety shut-down 2 = With fault lock-out
37	Post-purge time $t_{PN}$ 0-6000 = Time in seconds

Parameter	Name Value
38	Air flow monitoring during post-purge 0 = On; maximum capacity 1 = Off; maximum capacity 2 = Off; ignition capacity 3 = Off; controller enable
44	Controller enable signal delay time $t_{RF}$ 0-250 = Time in seconds
62	Minimum pause time $t_{MP}$ 0-3600 = Time in seconds
63	Switch-on delay time $t_E$ 0-250 = Time in seconds
67	Operating time in Manual mode 0 = Unlimited 1 = 5 minutes
69	Function of terminal 51 0 = Off 1 = IC 40/RBW max. capacity feedback 2 = AND with emergency stop (trm. 46) 3 = AND with air min. (trm. 47) 4 = AND with air flow monitoring (trm. 48) 5 = AND with gas min. (trm. 49) 6 = AND with gas max. (trm. 50)
70	Function of terminal 65 0 = Off 1 = Reduced DG test duration 2 = AND with emergency stop (trm. 46) 3 = AND with air min. (trm. 47) 4 = AND with air flow monitoring (trm. 48) 5 = AND with gas min. (trm. 49) 6 = AND with gas max. (trm. 50)
71	Function of terminal 66 0 = Off 1 = FCU as zone control unit 2 = External HT signal 3 = AND with emergency stop (trm. 46) 4 = AND with air min. (trm. 47) 5 = AND with air flow monitoring (trm. 48) 6 = AND with gas min. (trm. 49) 7 = AND with gas max. (trm. 50)
72	Function of terminal 67 0 = Off 1 = BCU ready; safety shut-down 2 = BCU ready; fault lock-out 3 = AND with emergency stop (trm. 46) 4 = AND with air min. (trm. 47) 5 = AND with air flow monitoring (trm. 48) 6 = AND with gas min. (trm. 49) 7 = AND with gas max. (trm. 50)
73	Function of terminal 68 0 = Off 1 = Contactor feedback 2 = AND with emergency stop (trm. 46) 3 = AND with air min. (trm. 47) 4 = AND with air flow monitoring (trm. 48) 5 = AND with gas min. (trm. 49) 6 = AND with gas max. (trm. 50)
77	Password 0000-9999

### 12.3 Additional parameters for FCU..H1

Parameter	Name Value
20	Temperature monitoring mode $0$ = Off $1$ = STM function (high temperature operation) $2$ = STL function $3$ = STM and STL functions
22	Thermocouple $1$ = Type K $2$ = Type N $3$ = Type S
23	Temperature difference limit value $10-100$ = Temperature in °C
24	STM limit value (high temperature operation) $650-1200$ = Temperature in °C
25	STL/FSTL limit value (system protection) $200-1600$ = Temperature in °C
26	Temperature hysteresis $10-100$ = Temperature in °C
27	Pre-purge during high temperature operation $0$ = Off $1$ = On

### 12.4 Additional parameters for FCU..F1

Parameter	Name Value
40	Capacity control $0$ = Off $1$ = IC 20 $2$ = IC 40
42	Running time $0-250$ = Time in seconds
45	Minimum enable time $0-250$ = Time in seconds
46	Burner operating signal $0$ = Off $1$ = On; controller enable
47	Controller enable time limit $0-60$ = Time in minutes

### 12.5 Additional parameters for FCU..F2

Parameter	Name Value
40	Capacity control $0$ = Off $3$ = RBW $4$ = Frequency converter
41	Selection of RBW running time $0$ = Off; position check $1$ = On; for min./max. capacity $2$ = On; for maximum capacity $3$ = On; for minimum capacity
42	Running time $0-250$ = Running time in seconds if parameter 41 = 1, 2 or 3

Parameter	Name Value
45	Minimum enable time $0-250$ = Time in seconds
46	Burner operating signal $0$ = Off $1$ = On; controller enable

### 12.6 Additional parameters for FCU..C1

























Parameter	Name Value
51	Valve proving system $0$ = Off $1$ = Tightness test before start-up $2$ = Tightness test after shut-down $3$ = Tightness test before start-up & after shut-down $4$ = POC function
53	Tightness control test volume $1$ = $V_{p1}$ $2$ = $V_{p1}$ ; pressure reduction via V3 $3$ = $V_{p1} + V_{p2}$ ; pressure reduction via V3 $4$ = $V_{p1} + V_{p3}$ ; pressure reduction via V3 $5$ = $V_{p1} + V_{p2} + V_{p3}$ ; pressure reduction via V3
54	Pressure reduction $V_{p2}$ $0$ = In standby $1$ = Upon start-up
55	Opening time relief valve V3 $t_{L3}$ $0-6000$ = Venting time before $V_{p1}$ test in seconds
56	Measurement time for $V_{p1}$ $3$ = Time in seconds $5-25$ = (in 5 s steps) $30-3600$ = (in 10 s steps)
57	Measurement time $V_{p1} + V_{p2}$ $3$ = Time in seconds $5-25$ = (in 5 s steps) $30-3600$ = (in 10 s steps)
59	Valve opening time 1 $t_{L1}$ $2-25$ = Time for filling or pressure reduction in seconds
60	Valve opening time 2 $t_{L2}$ $2-25$ = Time for filling or pressure reduction in seconds
65	Filling time before start-up $0-25$ = Time in seconds

### 12.7 Additional parameters for FCU with BCM 500

Parameter	Name Value
75	Capacity control (bus) $0$ = Off $1$ = MIN to MAX; STBY = MIN $2$ = MIN to MAX; STBY = CLOSED $3$ = IGNITION to MAX; STBY = CLOSED $4$ = MIN to MAX; STBY = MIN; quick start $5$ = IGNITION to MAX; STBY = MIN; quick start

Parameter	Name Value
80	Fieldbus communication 0 = Off 1 = On; with address check 2 = On; no address check

## 13 LEGEND

Symbol	Description
	Ready for operation
	Safety interlocks (limits)
	Controlled air flow
	Remote reset
LDS	Safety limits (limits during start-up)
	Gas valve
	Air valve
	Air/gas ratio control valve
	Burner
	Purge
	External air control
	Burner operating signal
	Fault message
	Start-up signal
	Input for high temperature operation
	Pressure switch for tightness control (TC)
	Pressure switch for maximum pressure
	Pressure switch for minimum pressure
	Differential pressure switch
	Input signal depending on parameter xx
	Actuator with butterfly valve
	Valve with proof of closure switch
	Three-point step switch
	Input/Output, safety circuit
	24 V DC input and output
TC	Tightness control

Symbol	Description
$p_U/2$	Half of the inlet pressure
$p_U/4$	A quarter of the inlet pressure
$3p_U/4$	Three-quarters of the inlet pressure
$p_U$	Inlet pressure
$p_d$	Outlet pressure
$V_{p1}$	Test volume
$I_N$	Current consumption of sensor/ contactor

## 14 TECHNICAL DATA

### 14.1 Ambient conditions

Avoid direct sunlight or radiation from red-hot surfaces on the unit.

Avoid corrosive influences, e.g. salty ambient air or SO<sub>2</sub>.

The unit may only be stored/installed in enclosed rooms/buildings.

This unit is not suitable for cleaning with a high-pressure cleaner and/or cleaning products.

Ambient temperature:

-20 to +60°C (-4 to +140°F),

no condensation permitted.

Enclosure: IP 20 pursuant to IEC 529.

Installation location: min. IP 54 (for installation in a control cabinet).

Permitted operating altitude: < 2000 m AMSL.

### 14.2 Mechanical data

Weight: 0.7 kg.

### Connections

- Screw terminals:
  - nominal cross-section 2.5 mm<sup>2</sup>,
  - wire cross-section (rigid): min. 0.2 mm<sup>2</sup>,
  - max. 2.5 mm<sup>2</sup>,
  - AWG: min. 24, max. 12.
  - Contact rating: 12 A.
- Spring force terminals:
  - nominal cross-section 2 × 1.5 mm<sup>2</sup>,
  - wire cross-section: min. 0.2 mm<sup>2</sup>,
  - max. 1.5 mm<sup>2</sup>,
  - AWG: min. 24, max. 16.
  - Contact rating: 10 A (UL: 8 A),
  - to be observed in case of daisy chain.

### 14.3 Electrical data

#### Mains voltage

FCU..Q: 120 V AC, -15/+10%, 50/60 Hz, ±5%,

FCU..W: 230 V AC, -15/+10%, 50/60 Hz, ±5%,  
for grounded mains only.

#### Power consumption

FCU..Q: at 120 V AC approx. 3 W/5.5 VA plus

approx. 0.08 W/0.2 VA per AC input,

FCU..W: at 230 V AC approx. 6 W/11 VA plus

approx. 0.15 W/0.4 VA per AC input.

## Contact rating

- Control outputs LDS (terminal 16), purge (terminal 17), HT (terminal 18), safety interlocks (terminal 57):  
max. 0.5 A,  $\cos \varphi = 1$ .
- Valve outputs V1, V2 and V3 (terminals 13, 14 and 15):  
max. 1 A,  $\cos \varphi = 1$ .
- Actuator outputs (terminals 53, 54 and 55):  
max. 50 mA  $\cos \varphi = 1$ .
- Total current for the simultaneous activation of control outputs HT, purge, LDS and safety interlocks, valve outputs V1, V2 and V3 and the actuator:  
max. 2.5 A.
- 24 V DC signalling contact for fault/operation (terminal 41, 42):  
max. 0.1 A.
- Fan:  
max. 3 A (start-up current:  $6 \text{ A} < 1 \text{ s}$ ).

## Number of operating cycles

FCU:

24 V DC signalling contact for fault/operation: max. 10,000,000,

On/Off button, Reset/Information button: 1000, power module:

control outputs LDS (terminal 16), purge (terminal 17), HT (terminal 18), safety interlocks (terminal 57),

gas valves V1 (terminal 13), V2 (terminal 14), V3 (terminal 15),

butterfly valve actuator (terminals 53, 54 and 55), fan (terminal 58): max. 250,000.

Input voltage of signal inputs:

Rated value	120 V AC	230 V AC
Signal "1"	80–132 V	160–253 V
Signal "0"	0–20 V	0–40 V

Rated value	24 V DC
Signal "1"	24 V, $\pm 10\%$
Signal "0"	$< 1 \text{ V}$

Signal input current:

Signal "1"	max. 5 mA
------------	-----------

Fuses, replaceable,

F1: T 3.15A H,

F2: T 5A H, pursuant to IEC 60127-2/5.

## 14.4 FCU..H1

Terminals 5, 6, 7 and 8:

Maximum voltage:  $\pm 5 \text{ V}$ .

Input voltage range for double thermocouples:

Type K: 0 to 54.9 mV,

Type N: 0 to 47.5 mV,

Type S: 0 to 18.7 mV.

Action: Type 2 to EN 14597,

functions: 2B, 2K and 2P,

with STL also 2A and 2N.

ESD protection of terminals 5 to 8:

Level 4 to IEC 61000-4-2 (ESD).

Maximum deviation of temperature values of STM/

STL module when using Class 1 thermocouples:

Type K: 0.63% at 25°C,  $\pm 340 \text{ ppm/K}$  at ambient temperature,

Type N: 0.55% at 25°C,  $\pm 340 \text{ ppm/K}$  at ambient temperature,

Type S: 1.38% at 25°C,  $\pm 1570 \text{ ppm/K}$  at ambient temperature.

## 15 DESIGNED LIFETIME

This information on the designed lifetime is based on using the product in accordance with these operating instructions. Once the designed lifetime has been reached, safety-relevant products must be replaced.

Designed lifetime (based on date of manufacture): 10 years.

You can find further explanations in the applicable rules and regulations and on the afecor website ([www.afecor.org](http://www.afecor.org)).

This procedure applies to heating systems. For thermoprocessing equipment, observe local regulations.

## 16 LOGISTICS

### Transport

Protect the unit from external forces (blows, shocks, vibration).

Transport temperature: see page 23 (14 Technical data).

Transport is subject to the ambient conditions described.

Report any transport damage on the unit or packaging without delay.

Check that the delivery is complete.

### Storage

Storage temperature: see page 23 (14 Technical data).

Storage is subject to the ambient conditions described.

Storage time: 6 months in the original packaging before using for the first time. If stored for longer than this, the overall service life will be reduced by the corresponding amount of extra storage time.



## 17 ACCESSORIES

### 17.1 BCSoft4

The current software can be downloaded from our Internet site at [www.docuthek.com](http://www.docuthek.com). To do so, you need to register in the DOCUTHEK.

### 17.2 Opto-adapter PCO 200

Including BCSoft CD-ROM,  
Order No.: 74960625.

### 17.3 Stickers for labelling

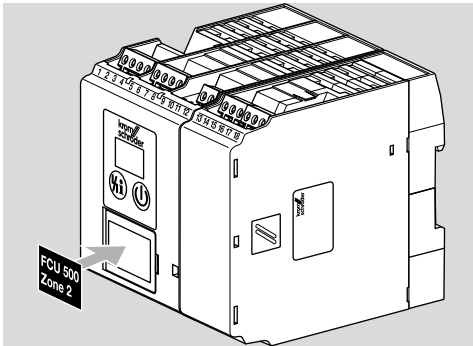

For printing with laser printers, plotters or engraving machines, 27 × 18 mm or 28 × 17.5 mm.  
Colour: silver.

### 17.4 Connection plug set

For wiring the FCU.

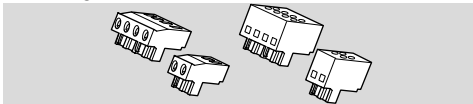

Connection plugs with screw terminals

Order No.: 74923998.

Connection plugs with spring force terminals

Order No.: 74924000.

### 17.5 OCU

Operator-control unit for installation in the control cabinet door. The program status or fault messages can be read on the OCU. In Manual mode, the OCU can be used to proceed through the sequence of operating steps.

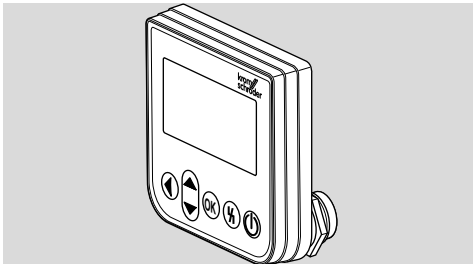

OCU 500-1,

switchable display: D, GB, F, NL, E, I,  
Order No. 84327030,

OCU 500-2,

switchable display: GB, DK, S, N, TR, P,  
Order No. 84327031,

OCU 500-3,

switchable display: GB, USA, E, P (BR), F,  
Order No. 84327032,

OCU 500-4,

switchable display: GB, RUS, PL, HR, RO, CZ,  
Order No. 84327033.

## 18 CERTIFICATION

### 18.1 Declaration of conformity



We, the manufacturer, hereby declare that the products FCU 500 and FCU 505 comply with the requirements of the listed Directives and Standards.

Directives:

- 2014/35/EU – LVD
- 2014/30/EU – EMC
- 2011/65/EU – RoHS II
- 2015/863/EU – RoHS III

Regulation:

- (EU) 2016/426 – GAR

Standards:

- EN 13611:2007+A2:2011
- EN 1643:2014
- EN 61508:2010, suitable for SIL 3

The relevant product corresponds to the tested type sample.

The production is subject to the surveillance procedure pursuant to Regulation (EU) 2016/426 Annex III paragraph 3.

Elster GmbH

### Certified to SIL and PL



For systems up to SIL 3 pursuant to EN 61508 and PL e pursuant to ISO 13849.

### FM approved



Factory Mutual (FM) Research Class: 7610 "Combustion Safeguards and Flame Sensing Systems". Suitable for applications pursuant to NFPA 86.

## ANSI/CSA approved



American National Standards Institute/Canadian Standards Association – ANSI Z21.20/CSA C22.2, No. 199

## 18.2 Eurasian Customs Union



The products FCU 500, FCU 505 meet the technical specifications of the Eurasian Customs Union.

## 18.3 REACH Regulation

The device contains substances of very high concern which are listed in the Candidate List of the European REACH Regulation No. 1907/2006. See Reach list HTS at [www.docuthek.com](http://www.docuthek.com).

## 18.4 China RoHS

Directive on the restriction of the use of hazardous substances (RoHS) in China. Scan of the Disclosure Table China RoHS2, see certificates at [www.docuthek.com](http://www.docuthek.com).

## 19 DISPOSAL

Devices with electronic components:

### WEEE Directive 2012/19/EU – Waste Electrical and Electronic Equipment Directive



At the end of the product life (number of operating cycles reached), dispose of the packaging and product in a corresponding recycling centre. Do not dispose of the unit with the usual domestic refuse. Do not burn the product.

On request, old units may be returned carriage paid to the manufacturer in accordance with the relevant waste legislation requirements.

## FOR MORE INFORMATION

The Honeywell Thermal Solutions family of products includes Honeywell Combustion Safety, Eclipse, Exothermics, Hauck, Kromschroder and Maxon. To learn more about our products, visit [ThermalSolutions.honeywell.com](http://ThermalSolutions.honeywell.com) or contact your Honeywell Sales Engineer.  
Elster GmbH  
Strotheweg 1, D-49504 Lotte  
T +49 541 1214-0  
[hts.lotte@honeywell.com](mailto:hts.lotte@honeywell.com)  
[www.kromschroeder.com](http://www.kromschroeder.com)

Global centralized service deployment coordination:  
T +49 541 1214-365 or -555  
[hts.service.germany@honeywell.com](mailto:hts.service.germany@honeywell.com)

Translation from the German  
© 2024 Elster GmbH

**Honeywell**  
**kromschroder**