

Pressure regulators with solenoid valve VAD, VAG, VAV, VAH, flow rate regulators VRH, pressure regulators with double solenoid valve VCD, VCG, VCV, VCH

OPERATING INSTRUCTIONS

Cert. Version 07.19 · Edition 05.24 · EN · 03250481



1 SAFETY

1.1 Please read and keep in a safe place



Please read through these instructions carefully before installing or operating. Following the installation, pass the instructions on to the operator. This unit must be installed and commissioned in accordance with the regulations and standards in force. These instructions can also be found at www.docuthek.com.

1.2 Explanation of symbols

1, 2, 3, a, b, c = Action

→ = Instruction

1.3 Liability

We will not be held liable for damage resulting from non-observance of the instructions and non-compliant use.

1.4 Safety instructions

Information that is relevant for safety is indicated in the instructions as follows:



DANGER

Indicates potentially fatal situations.



WARNING

Indicates possible danger to life and limb.



CAUTION

Indicates possible material damage.

All interventions may only be carried out by qualified gas technicians. Electrical interventions may only be carried out by qualified electricians.

1.5 Conversion, spare parts

All technical changes are prohibited. Only use OEM spare parts.

CONTENTS

1 Safety	1
2 Checking the usage	2
3 Installation	3
4 Installing the gas/air control lines	5
5 Wiring	6
6 Tightness test	8
7 Commissioning	8
8 Replacing the actuator	10
9 Replacing the circuit board	11
10 Maintenance	12
11 Accessories	13
12 Technical data	17
13 Air flow rate Q	18
14 Designed lifetime	19
15 Certification	19
16 Logistics	20
17 Disposal	20
18 Pressure units	20

2 CHECKING THE USAGE

Pressure regulators with solenoid valve VAD, VAG, VAV, VAH

Type	Designation of regulator type
VAD	Pressure regulator with solenoid valve
VAG	Air/gas ratio control with solenoid valve
VAV	Variable air/gas ratio control with solenoid valve
VAH	Flow rate regulator with solenoid valve

Constant pressure governor VAD for shut-off and precise control of the gas supply to excess air burners, atmospheric burners or force draught gas burners.

Air/gas ratio control VAG for shut-off and for maintaining a constant air/gas pressure ratio of 1:1 for modulating-controlled burners or with bypass valve for stage-controlled burners. Can be used as zero governor for gas engines.

Variable air/gas ratio control VAV for shut-off and for maintaining a constant air/gas pressure ratio for modulating-controlled burners. The transmission ratio of gas to air can be set from 0.6:1 to 3:1. Pressure fluctuations in the combustion chamber can be compensated via the combustion chamber control pressure p_{sc} .

Flow rate regulator VAH for maintaining a constant gas/air ratio for modulating-controlled and stage-controlled burners. The gas flow rate is controlled proportionally to the air flow rate. In addition, the flow rate regulator with gas solenoid valve shuts off the gas or air supply safely.

Flow rate regulator VRH

Type	Designation of regulator type
VRH	Flow rate regulator

Flow rate regulator VRH for maintaining a constant gas/air ratio for modulating-controlled and stage-controlled burners. The gas flow rate is controlled proportionally to the air flow rate.

Pressure regulators with double solenoid valve VCD, VCG, VCV, VCH

Type	Combination of gas solenoid valve + regulator with solenoid valve
VCD	VAS + VAD
VCG	VAS + VAD
VCV	VAS + VAV
VCH	VAS + VAH

Gas solenoid valves VAS for safeguarding gas or air on various appliances. Pressure regulators with double solenoid valve VCx are combinations of two gas solenoid valves with a pressure regulator. This function is only guaranteed when used within the specified limits – see page 17 (12 Technical data). Any other use is considered as non-compliant.

2.1 Type code

VAD	Pressure regulator with solenoid valve
VAG	Air/gas ratio control with solenoid valve
VAH	Flow rate regulator with solenoid valve
VAV	Variable air/gas ratio control with solenoid valve
VRH	Flow rate regulator
1-3	Sizes
15-50	Inlet and outlet flange nominal size
R	Rp internal thread
F	Flange to ISO 7005
/N	Quick opening, quick closing
W	Mains voltage 230 V AC, 50/60 Hz
Y	Mains voltage 200 V AC, 50/60 Hz
Q	Mains voltage 120 V AC, 50/60 Hz
P	Mains voltage 100 V AC, 50/60 Hz
K	Mains voltage 24 V DC
SR	Closed position switch with visual position indicator, right
SL	Closed position switch with visual position indicator, left
GR	Closed position switch for 24 V and visual position indicator, right
GL	Closed position switch for 24 V and visual position indicator, left
-25	Outlet pressure p_d for VAD: 2.5–25 mbar
-50	Outlet pressure p_d for VAD: 20–50 mbar
-100	Outlet pressure p_d for VAD: 35–100 mbar
A	Standard valve seat
B	Reduced valve seat
E	VAG, VAV, VAH, VRH: connection for air control pressure: compression fitting
K	VAG, VAV: connection for air control pressure: plastic hose coupling
A	VAG, VAV, VAH, VRH: connection for air control pressure: 1/8" NPT adapter
N	VAG: zero governor VRH: no solenoid valve

2.2 Part designations

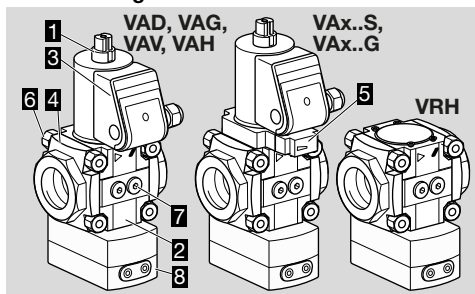

- 1 Solenoid actuator
- 2 Flow body
- 3 Connection box
- 4 Connection flange
- 5 Closed position indicator CPI
- 6 Connection parts
- 7 Regulator

2.3 Type label

Mains voltage, electrical power consumption, ambient temperature, enclosure, inlet pressure and installation position: see type label.

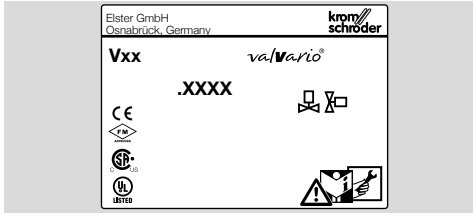

3 INSTALLATION

⚠ CAUTION

Incorrect installation

Please observe the following to ensure that the unit is not damaged during installation and operation:

- Sealing material and dirt, e.g. thread cuttings, must not be allowed to get into the valve housing.
- A filter must be installed upstream of every system.
- Always install an activated carbon filter upstream of the regulator when air is the medium. Otherwise, the ageing of elastomer materials will be accelerated.
- Dropping the device can cause permanent damage. In this event, replace the entire device and associated modules before use.
- Do not clamp the unit in a vice. Only secure the flange by holding the octagon with a suitable spanner. Risk of external leakage.
- It is not permitted to install gas solenoid valve VAS downstream of flow rate regulator VAH/VRH and upstream of fine-adjusting valve VMV. The VAS would no longer be able to perform its function as a second safety valve if installed in the above-mentioned position.
- If more than three valVario controls are installed in line, the controls must be supported.
- Device with POC/CPI VAx..SR/SL: actuator cannot be rotated.
- In the case of double solenoid valves, the position of the connection box can only be changed by removing the actuator and reinstalling it rotated by 90° or 180°.

When using a non-return gas valve GRS, we recommend installing the non-return gas valve upstream of the regulator and downstream of the gas solenoid valves due to the permanent pressure loss on the GRS.

- When joining two valves, determine the position of the connection boxes, push through the knock-outs in the connection boxes and install a cable gland set before installation in the

pipework, see accessories, cable gland set for double solenoid valves.

- Install the unit in the pipe free of mechanical stress.
- For retrofitting a second gas solenoid valve, use the double block seal instead of O-rings. The double block seal is supplied with the seal set, see accessories, seal set for sizes 1–3.

Installation position

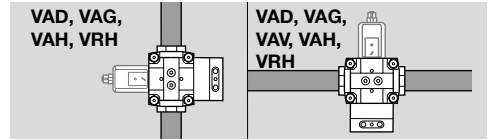

VAD, VAG, VAH: black solenoid actuator in the vertical upright position or tilted up to the horizontal, not upside down. In humid environments: black solenoid actuator in the vertical upright position only. VAG/VAH/VRH: in the horizontal position with modulating control: min. inlet pressure $p_{U \text{ min.}} = 80 \text{ mbar}$ (32 "WC).

VAV: black solenoid actuator in the vertical position, not upside down.

- The housing must not be in contact with masonry, minimum clearance 20 mm (0.79").
- Ensure that there is sufficient space for installation, adjustment and maintenance work. Minimum clearance of 50 cm (19.7") above the black solenoid actuator.

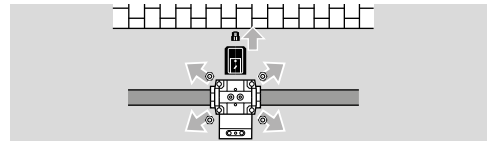

- To prevent vibrations, keep the volume between the regulator and burner small by using short pipes ($\leq 0,5 \text{ m}$, $\leq 19,7"$).

The inlet pressure p_U can be measured on both sides of the valve body.

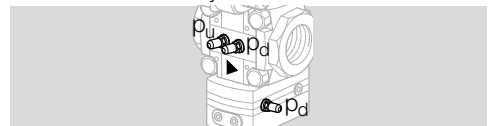

The outlet pressure p_d (p_{d1} and p_{d2}) and the air control pressure p_{sa} (p_{sa1} and p_{sa2}) must only be measured at the designated places on the regulator using test nipples.

VAD

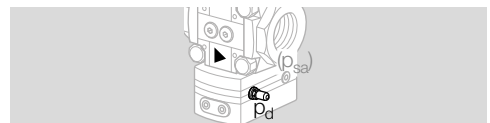

Test point for the gas outlet pressure p_d on the regulator body. A combustion chamber control line (p_{sc}) can be connected at connection p_{sa} for maintaining

a constant burner capacity (1/8" coupling with compression fitting for 6 x 1 tube).

VAG

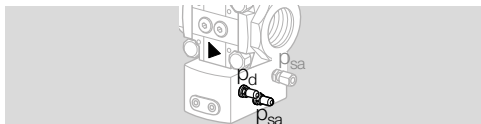

VAV

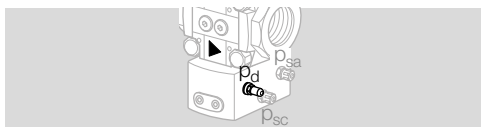

VAH, VRH

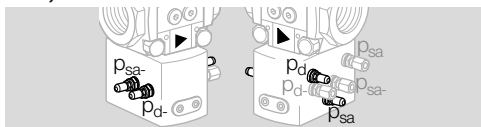

To increase the control accuracy, an external impulse line can be connected, instead of pressure test point p_d : Gas impulse line p_{di} : distance from flange $\geq 3 \times DN$, use a 8 x 1 mm steel tube and a G1/8.. coupling for $D = 8$ mm.

⚠ CAUTION

Do not bridge downstream VAS with external impulse line.

Strainer

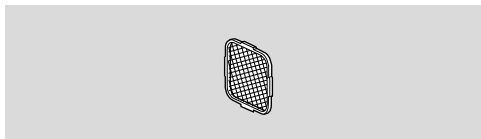

→ A strainer must be fitted in the unit on the inlet side. If two or more gas solenoid valves are installed in line, then a strainer only needs to be fitted on the inlet side of the first valve.

Differential pressure orifice

→ An appropriate differential pressure orifice with rubber seals **G** must be inserted at the outlet of the unit, depending on the pipe.

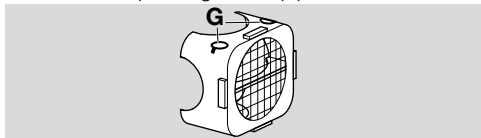

	Pipe DN	Differential pressure orifice			Order No.
		Colour	Outlet dia.		
			mm	inch	
VAX 1	15	Yellow	18.5	0.67	74922238
VAX 1	20	Green	25	0.98	74922239
VAX 1	25	Trans-parent	30	1.18	74922240
VAX 2	40	Trans-parent	46	1.81	74924907
VAX 3	50	Trans-parent	58	2.28	74924908

If pressure regulator VAD/VAG/VAV 1 is retrofitted upstream of gas solenoid valve VAS 1, a DN 25 differential pressure orifice with outlet opening $d = 30$ mm (1.18") must be inserted at the outlet of the pressure regulator.

In the case of pressure regulator VAX 115 or VAX 120, the DN 25 differential pressure orifice must be ordered separately and retrofitted, Order No. 74922240.

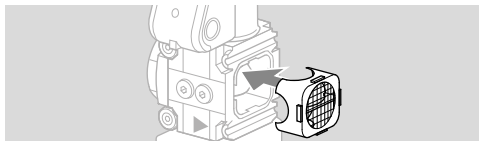

→ The retaining frame must be fitted to secure the differential pressure orifice at the outlet of the regulator.

Retaining frame

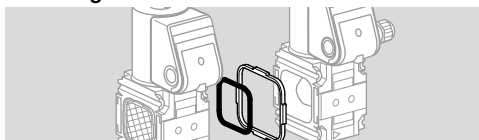

→ If two controls (regulators or valves) are assembled, a retaining frame with double block seal must be fitted.

Order No. for seal set: size 1: 74921988, size 2: 74921989, size 3: 74921990.

Compression fittings

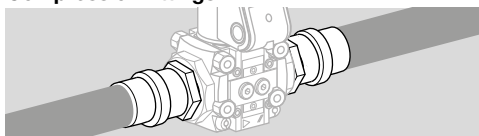

→ The seals in some compression fittings are approved for temperatures of up to 70°C (158°F). This temperature limit will not be exceeded if the flow through the pipe is at least 1 m³/h (35.31 SCFH) of gas and the maximum ambient temperature is 50°C (122°F).

1 Remove the adhesive label or screw cap from the inlet and outlet.

2 Obey the direction of flow as marked on the housing.

3.1 VAX with flanges

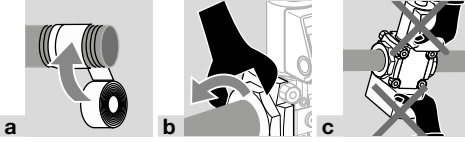

3.2 VAX without flanges



→ O-ring and strainer (Fig. c) must be fitted.

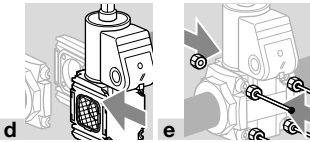

→ Note the recommended tightening torques for the connection parts. See page 18 (12.2.1 Tightening torque).

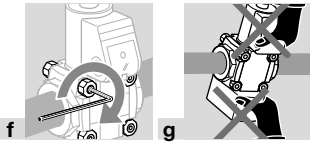

4 INSTALLING THE GAS/AIR CONTROL LINES

CAUTION

Incorrect installation

Please observe the following to ensure that the unit is not damaged during installation and operation:

- Fit control lines so that no condensation can enter the unit.
- The control lines must be as short as possible. Internal diameter ≥ 3.9 mm (0.15").
- Any bends, restriction points, deviations or air control valves must be at a distance of at least 5 x DN from the connection.
- Check the connections, pressures, adjusting range, transmission ratio and pressure differentials. See page 17 (12.2 Mechanical data).

VAG

Installing the air control line p_{sa}

1 Install the connection for the air control line in the centre of a straight pipeline which is at least 10 x DN long.

→ VAG..K: 1 x 1/8" coupling for plastic hose (internal dia. 3.9 mm (0.15"), external dia. 6.1 mm (0.24")).

→ VAG..E: 1 x 1/8" coupling with compression fitting for 6 x 1 tube.

→ VAG..N: connection p_{sa} must remain open.

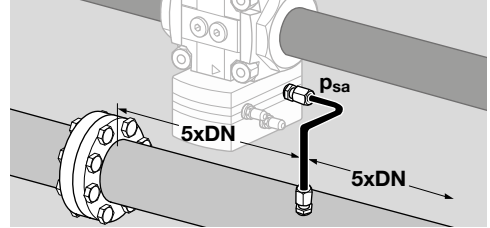

VAV

Installing the air control line p_{sa} and the combustion chamber control line p_{sc}

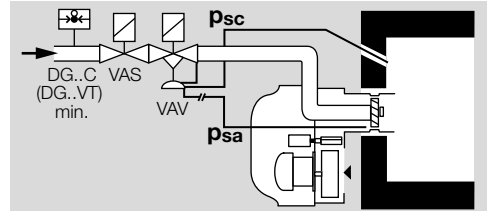

→ VAV..K: 2 plastic hose couplings (internal dia. 3.9 mm (0.15"); external dia. 6.1 mm (0.24")) available.

→ Do not remove the couplings or replace them with other types of coupling.

1 Route air control line p_{sa} and combustion chamber control line p_{sc} to the test points for air and combustion chamber pressure.

→ If p_{sc} is not connected, do not plug the opening!
2 Install the connection for the air control line in the centre of a straight pipeline which is at least 10 x DN long.

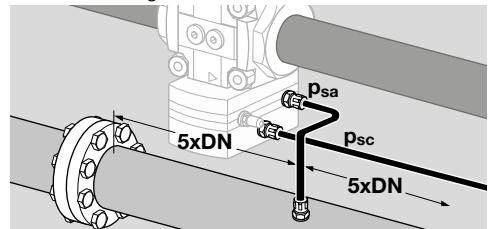

VAH/VRH

Installing the air control lines p_{sa}/p_{sa-} and the gas control line p_d .

→ 3 x 1/8" couplings with compression fitting for 6 x 1 tube.

1 To measure the differential air pressure, install a measuring orifice in the air line, ensuring that the inlet and outlet section is ≥ 5 DN.

2 Connect the air control line p_{sa} to the inlet of the measuring orifice and the air control line p_{sa-} to the outlet of the measuring orifice.

→ p_d is an internal hole/feedback in the unit.

VAH

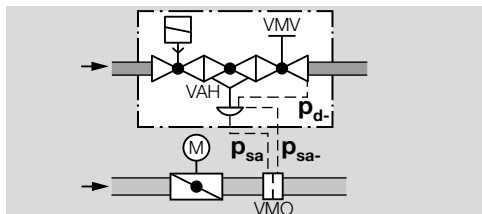

VRH

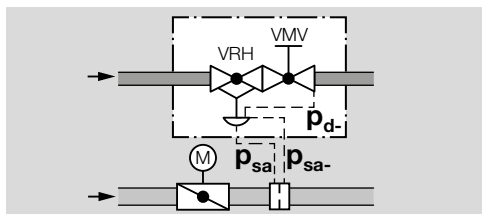

3 We recommend installing a fine-adjusting valve VMV directly downstream of the regulator in the gas line. See "Filter module VMF, measuring orifice VMO, fine-adjusting valve VMV" operating instructions. The instruction manual can also be found at www.docuthek.com.

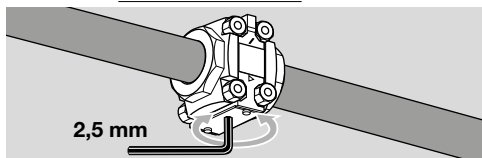

→ If, instead of installing a VMV, a measuring orifice is installed in the gas line, ensure that the inlet and outlet section is ≥ 5 DN.

4 Connect the gas control line p_d to the VMV or to the measuring orifice.

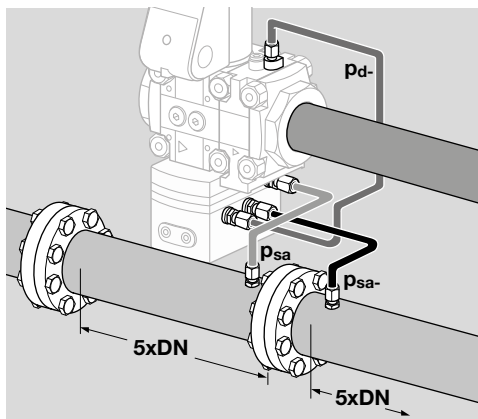

5 WIRING

⚠ WARNING

Risk of injury!

Please observe the following to ensure that no damage occurs:

- Electric shocks can be fatal! Before working on possible live components, ensure the unit is disconnected from the power supply.
- The solenoid actuator heats up during operation. Surface temperature approx. 85°C (approx. 185°F).



→ Use temperature-resistant cable ($> 80^\circ\text{C}$).

1 Disconnect the system from the electrical power supply.

2 Shut off the gas supply.

→ UL requirements for the NAFTA market. To maintain the UL environmental rating Type 2, the enclosure openings shall be closed with fittings rated UL Type 2; 3; 3R; 3RX; 3S; 3SX; 3X; 4X; 5; 6; 6P; 12; 12K or 13. Gas solenoid valves shall be protected by a branch circuit protective device not exceeding 15 A.

→ Wiring to EN 60204-1.

→ Push through and remove the knock-out in the connection box before removing the cover. If the M20 cable gland or plug is already fitted, it is not necessary to remove the knock-out.

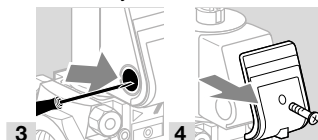

M20 cable gland

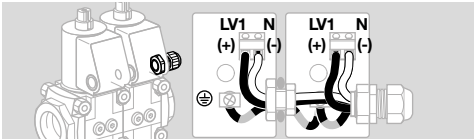
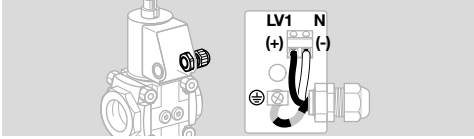
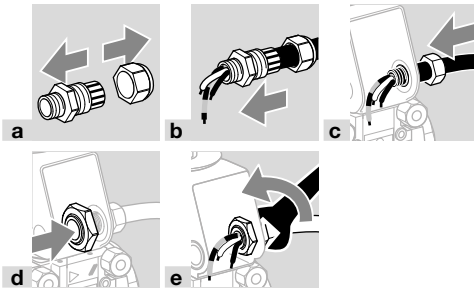

Plug

→ LV1_{V1} (+) = black, LV1_{V2} (+) = brown, N (-) = blue

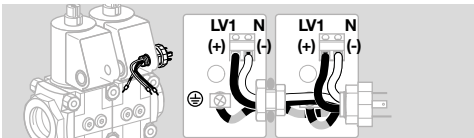
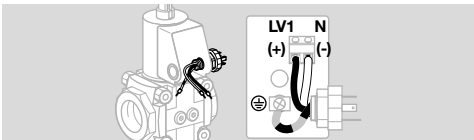
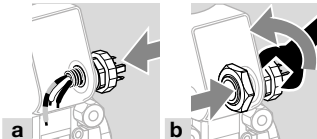

Socket

→ 1 = N (-), 2 = LV1_{V1} (+), 3 = LV1_{V2} (+)

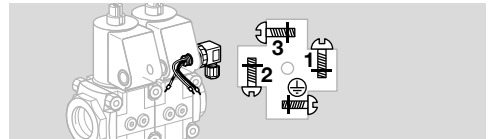
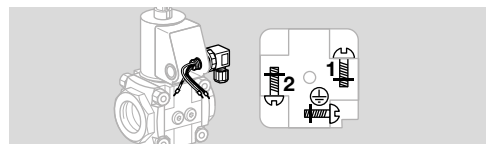
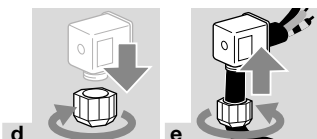
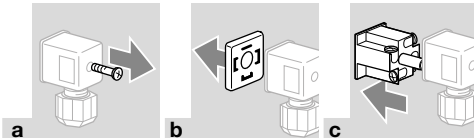

Closed position indicator

- VAX open: contacts 1 and 2 closed, VAX closed: contacts 1 and 3 closed.
- Indicator of closed position indicator: red = VAX open, white = VAX closed.
- Double solenoid valve: if a plug with socket is fitted, only one closed position indicator can be connected.

CAUTION

Please observe the following to ensure smooth operation:

- The closed position indicator is not suitable for frequent cycling operation.
- Route valve and closed position indicator cables separately through M20 cable glands or use two separate plugs. Otherwise, there is a risk of interference between valve voltage and closed position indicator voltage.
- To make wiring easier, the connection terminal for the proof of closure switch can be removed.

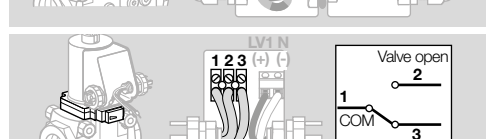
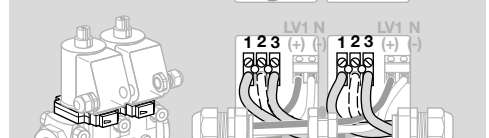
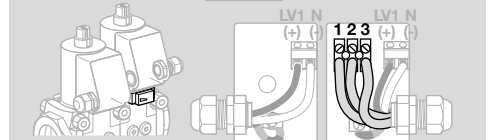
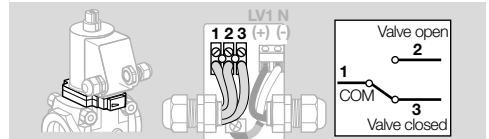

- When installing two plugs on VAX a with proof of closure switch: label the sockets and plugs to avoid confusion.

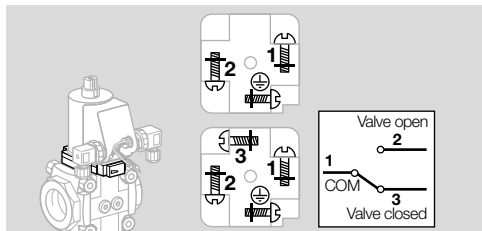

- Ensure that the connection terminal for the closed position indicator has been reconnected.

Finishing the wiring

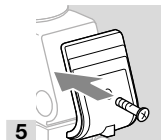

6 TIGHTNESS TEST

- 1 Close the gas solenoid valve.
 - 2 To be able to check the tightness, shut off the downstream pipeline close to the valve.
- On the VAH/VRH, the control line p_{d-} leads to gas-filled space in the regulator. It must be connected before the tightness test.

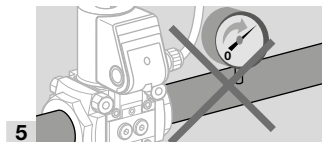

- 6 Open the pressure regulator.

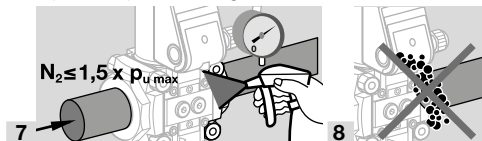

- 9 Tightness OK: open the pipeline.

- Pipeline leaking: replace the seal on the flange, see accessories.
Order No. for seal set: size 1: 74921988, size 2: 74921989, size 3: 74921990.
Then check for tightness once again.
- Unit leaking: remove the unit and return it to the manufacturer.

7 COMMISSIONING

- Ensure that the length of the tube is as short as possible for the determining of the pressures during the measurement process.

VAD

Setting the outlet pressure p_d

- The outlet pressure is set to $p_d = 10$ mbar at the factory.

	p_d	
	[mbar]	["WC]
VAD...-25	2.5–25	1–10
VAD...-50	20–50	8–19.7
VAD...-100	35–100	14–40

- 1 Switch on the burner.
- Breathing orifice **A** must remain open.
- 2 Set the regulator to the required outlet pressure.

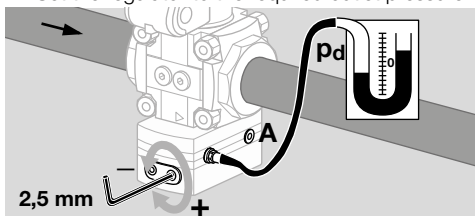

- 3 Close off the test point again once the pressure has been set.

VAG

p_d = Outlet pressure

p_{sa} = Air control pressure

- Factory setting: $p_d = p_{sa} - 1.5$ mbar (0.6 "WC); actuator pointing upwards and an inlet pressure of 20 mbar (7.8 "WC)

- 1 Switch on the burner.

Setting the low-fire rate

- In applications with excess air, the values for p_d and p_{sa} may be below the limit, see page 17 (12.2 Mechanical data). No situation which would jeopardize safety must arise. Avoid CO formation.

- 2 Set the regulator to the required outlet pressure.

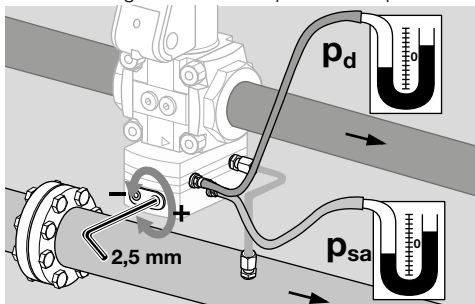

- 3 Close off the test point again once the pressure has been set.

Setting the high-fire rate

→ Set the high-fire rate using restricting orifices or adjustment elements on the burner.

VAV

p_d = Outlet pressure

p_{sa} = Air control pressure

p_{sc} = Combustion chamber control pressure

Setting the low-fire rate

→ If the burner operates at low-fire rate, the gas/air mixture can be changed by adjusting the adjusting screw "N".

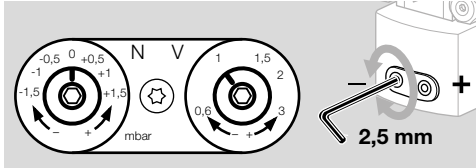

CAUTION

$p_{sa} - p_{sc} \geq 0.4 \text{ mbar}$ ($\geq 0.15 \text{ "WC}$). Controller acting time for the reference variable (air butterfly valve): min. to max. > 5 s, max. to min. > 5 s.

→ Factory setting for transmission ratio of gas to air: $V = 1:1$, zero point $N = 0$.

Presetting

1 Set zero point **N** and transmission ratio **V** to scale in accordance with burner manufacturer's specifications.

2 Measure gas pressure p_d .

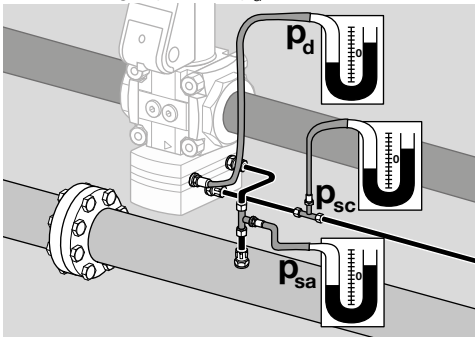

3 Start the burner at low-fire rate. If the burner does not start, turn **N** slightly in direction + and repeat start.

4 Gradually increase the burner to high fire and, if necessary, adjust the gas pressure at **V**.

5 Set the minimum and maximum capacity on the air control valve in accordance with burner manufacturer's specifications.

Final adjustment

6 Set the burner to low fire.

7 Conduct a flue gas analysis and set the gas pressure at **N** to the desired analysis value.

8 Set the burner to high fire and set the gas pressure at **V** to the desired analysis value.

9 Repeat the analysis at low and high fire and correct **N** and **V** if necessary.

10 Close off all test points. Do not close off connection p_{sc} if not used!

→ It is advisable to start the burner at a level higher than the minimum setting (start gas rate) to ensure reliable flame formation.

Calculation

If the combustion chamber control pressure p_{sc} is not connected:

$$p_d = V \times p_{sa} + N$$

If combustion chamber control pressure p_{sc} is connected:

$$(p_d - p_{sc}) = V \times (p_{sa} - p_{sc}) + N$$

Testing control capacity

DANGER

Risk of explosion!

If the control capacity is insufficient, the system may not be operated.

11 Set the burner to high fire.

12 Measure the gas pressure at the inlet and outlet.

13 Slowly close the manual valve upstream of the regulator until the gas inlet pressure p_u drops.

→ The gas outlet pressure p_d should not drop, however. Otherwise, the setting should be re-checked and adjusted.

14 Reopen the manual valve.

VAH, VRH

p_u = Inlet pressure

p_d = Outlet pressure

Δp_d = Differential gas pressure (outlet pressure)

p_{sa} = Air control pressure

Δp_{sa} = Differential air pressure (air control pressure)

→ A gas/air mixture may be applied at the p_{sa} -connection for the air control pressure.

→ Inlet pressure p_u : max. 500 mbar

→ Air control pressure p_{sa} : 0.6 to 100 mbar

→ Differential air pressure Δp_{sa} ($p_{sa} - p_{sa-}$) = 0.6 to 50 mbar

→ Differential gas pressure Δp_d ($p_d - p_{d-}$) = 0.6 to 50 mbar

→ The impulse lines p_{sa} , p_{sa-} and p_d - must be laid correctly.

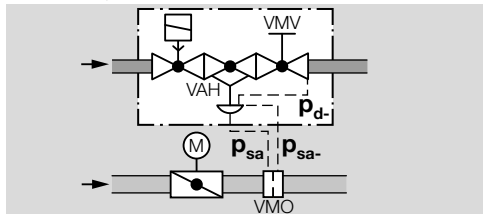

Presetting

- 1 Set the minimum and maximum capacity on the air control valve in accordance with burner manufacturer's specifications.
- 2 Switch on the burner.

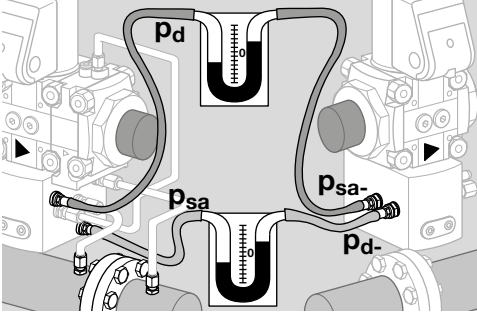

- 3 Open the fine-adjusting valve VMV slowly, from the ignitable mixture with excess air to the required value.

Setting the high-fire rate

- 4 Slowly increase the burner to high fire and set the differential gas pressure on the fine-adjusting valve VMV in accordance with burner manufacturer's specifications.

Setting the low-fire rate

- 5 If the burner operates at low-fire rate, the gas/air mixture can be changed by adjusting the adjusting screw **N**.

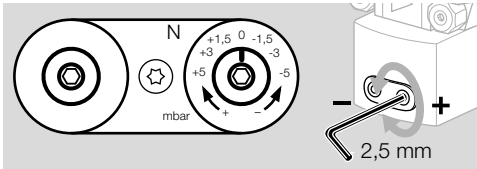

→ Factory setting: zero point N = -1.5 mbar

CAUTION

$\Delta p_{sa} = p_{sa} - p_{sa-} \geq 0.6 \text{ mbar} (\geq 0.23 \text{ "WC})$. Controller acting time for the reference variable (air butterfly valve): min. to max. > 5 s, max. to min. > 5 s.

- 6 Set the burner to low fire.
- 7 Conduct a flue gas analysis and set the gas pressure at **N** to the desired analysis value.
- 8 Set the burner to high fire and set the differential gas pressure to the desired analysis value.
- 9 Repeat the analysis at low and high fire and correct if necessary.
- 10 Close off all test points.

8 REPLACING THE ACTUATOR

→ The actuator adapter set for the new actuator must be ordered separately.



VAx 1, VCx 1: Order No. 74924468,
VAx 2-3, VCx 2-3: Order No. 74924469.

8.1 Removing the actuator

VAx, VCx

- 1 Disconnect the system from the electrical power supply.
- 2 Close the gas supply.

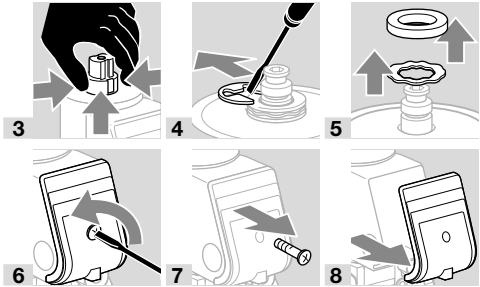

→ Remove the M20 cable gland or other type of connection.

VAx, VCx without closed position indicator

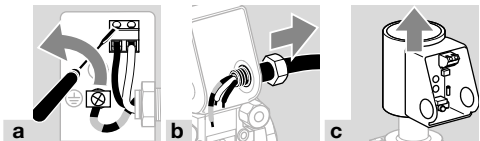

VAx, VCx with closed position indicator

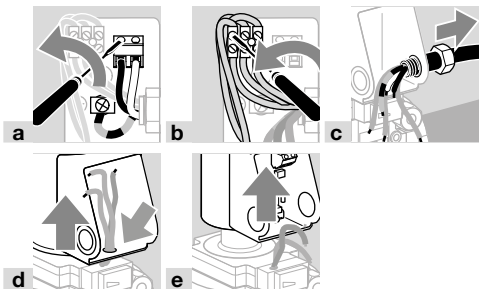

8.2 Fitting the new actuator

→ The seals of the actuator adapter set are covered with a non-stick coating. No additional grease is required.

→ Depending on the construction stage of the unit, there are two different methods for replacing the actuator:

If the unit concerned has no O-ring in this place (arrow), replace the actuator as described here. Otherwise, go to the next note.

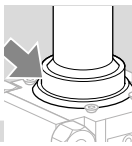

1

2 Insert seals.

3 Position of the metal ring can be selected.

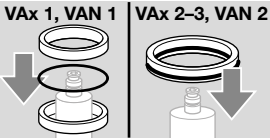

4

5 Slide seal under the second groove.

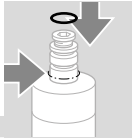

6

→ If the unit concerned has an O-ring in this place (arrow), replace the actuator as described here: VAX/VCx 1: use all seals from the actuator adapter set. VAX/VCx 2-VAX/VCx 3: use the small seal from the actuator adapter set and only one of the large seals.

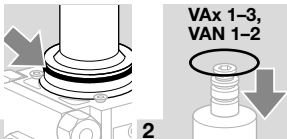

1

2

3 Slide seal under the second groove.

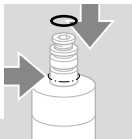

4

VAX, VCx without damping unit

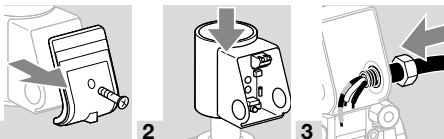

1

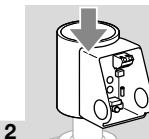

2

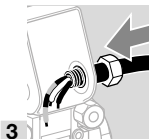

3

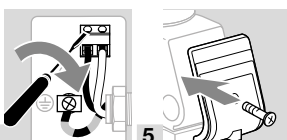

4

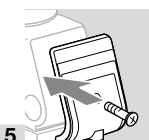

5

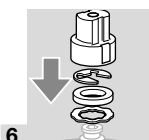

6

7 Open the gas solenoid valve and the gas supply.

VAX, VCx with POC/CPI

→ Depending on the switch design, one of the two enclosed seals must be inserted in the connection box housing.

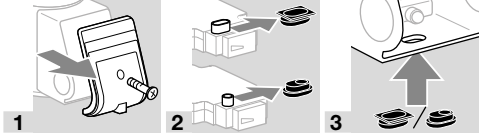

1

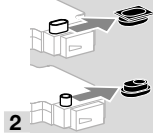

2

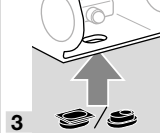

3

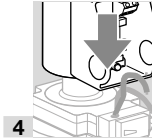

4

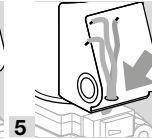

5



6

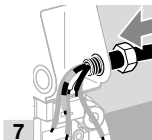

7

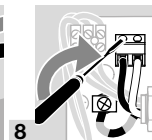

8



9

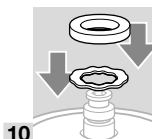

10



11

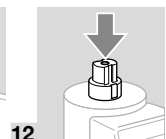

12

13 Open the gas solenoid valve and the gas supply.

9 REPLACING THE CIRCUIT BOARD

⚠ WARNING

Risk of injury!

Please observe the following to ensure that no damage occurs:

- Electric shocks can be fatal! Before working on possible live components, ensure the unit is disconnected from the power supply.
- The solenoid actuator heats up during operation. Surface temperature approx. 85°C (approx. 185°F).



→ We recommend making a note of the contact assignment for subsequent rewiring.

→ 1 = N (-), 2 = LV1 (+)

1 Disconnect the system from the electrical power supply.

2 Close the gas supply.

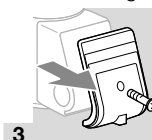

3

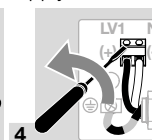

4

→ If a POC switch is wired, disconnect it.

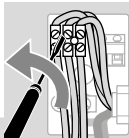

→ Keep all components for subsequent assembly in a safe place.

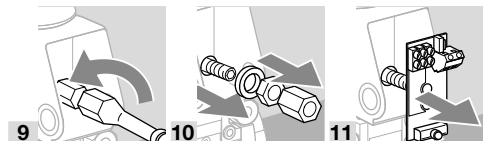
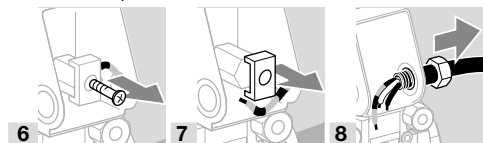

12 Insert new circuit board.

13 Follow the reverse procedure when reassembling.

14 Re-establish all connections.

→ Wire the new circuit board, see page 6 (5 Wiring).

→ Leave the connection box open for the electrical system test.

9.1 Electric strength test

1 Once the wiring has been carried out and before the devices are commissioned, a voltage surge test must be carried out.

Test points: mains connection terminals (N, L) with respect to PE wire terminal (PE ⊕).

Rated voltage > 150 V: 1752 V AC or 2630 V DC, testing time 1 second.

Rated voltage ≤ 150 V: 1488 V AC or 2240 V DC, testing time 1 second.

2 Screw the cover onto the connection box once the electrical test has been completed successfully.

3 The unit is fit for use again.

10 MAINTENANCE

⚠ CAUTION

In order to ensure smooth operation, check the tightness and function of the unit:

- Once per year, twice per year in the case of biogas; check for internal and external tightness, see page 8 (6 Tightness test).
- Check electrical installations once a year in line with local regulations; pay particular attention to the PE wire, see page 6 (5 Wiring).

- If the flow rate has dropped, clean the strainer and the differential pressure orifice.
- If more than one valVario control is installed in series: the controls may only be removed from the pipeline and reinstalled on the inlet and outlet flange all at once.
- We recommend replacing the seals, see accessories, page 13 (11.2 Seal set for sizes 1–3).

1 Disconnect the system from the electrical power supply.

2 Shut off the gas supply.

3 Detach control line(s).

4 Undo connection parts.

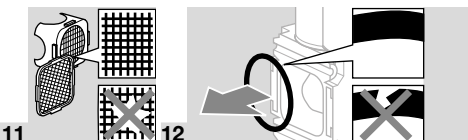
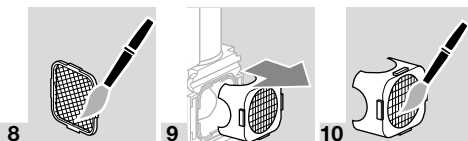
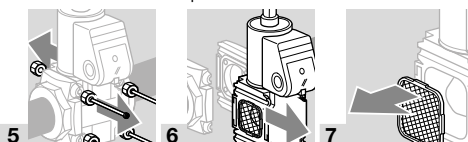

13 Once the seals have been replaced, refit the strainer and the differential pressure orifice and install the pressure regulator in the pipeline again.

14 Reattach control line(s) to the regulator.

→ The pressure regulator remains closed.

15 Then check the unit for internal and external tightness, see page 8 (6 Tightness test).

11 ACCESSORIES

11.1 Differing illustrations

Illustrations may differ from your VAX.

11.2 Seal set for sizes 1-3

When retrofitting accessories or a second valVario control or when servicing, we recommend replacing the seals.

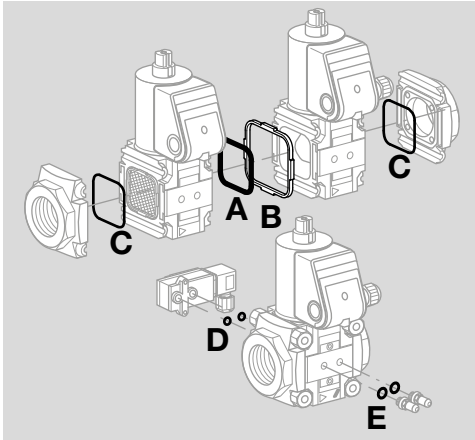

VAX 1-3

VA 1, Order No. 74921988,

VA 2, Order No. 74921989,

VA 3, Order No. 74921990.

Scope of delivery:

A 1 x double block seal,

B 1 x retaining frame,

C 2 x O-rings (flange),

D 2 x O-rings (pressure switch),

for test nipple/screw plug:

E 2 x sealing rings (flat sealing),

2 x profiled sealing rings.

VCx 1-3

VA 1, Order No. 74924978,

VA 2, Order No. 74924979,

VA 3, Order No. 74924980.

Scope of delivery:

A 1 x double block seal,

B 1 x retaining frame.

11.3 Pressure switch for gas DG..VC

The pressure switch for gas monitors the inlet pressure p_u , the interspace pressure p_z and the outlet pressure p_d .

- Monitoring the inlet pressure p_u : the pressure switch for gas is mounted on the inlet side.
- Monitoring the outlet pressure p_d : the pressure switch for gas is mounted on the outlet side.

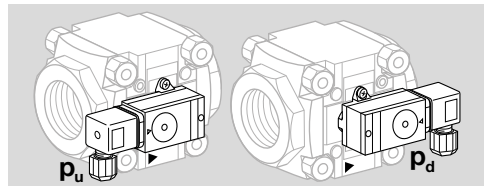

Scope of delivery:

1 x pressure switch for gas,

2 x self-tapping retaining screws,

2 x sealing rings.

Also available with gold-plated contacts for voltages of 5 to 250 V.

When using two pressure switches on the same side of the double solenoid valve, only the combination DG..C..1 and DG..C..9 may be used for design reasons.

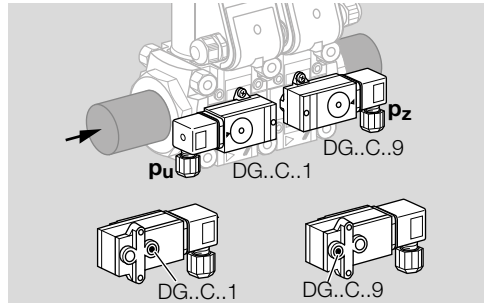

- When retrofitting the pressure switch for gas, see enclosed operating instructions "Pressure switches for gas DG..C", section entitled "Mounting the DG..C.. on valVario gas solenoid valves".

- The switching point is adjustable via hand wheel.

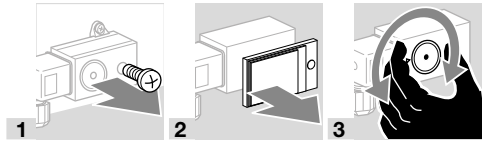

Type	Adjusting range (adjusting tolerance = ± 15% of the scale value)		Mean switching differential at min. and max. setting	
	[mbar]	[°WC]	[mbar]	[°WC]
DG 17VC	2-17	0.8-6.8	0.7-1.7	0.3-0.8
DG 40VC	5-40	2-16	1-2	0.4-1
DG 110VC	30-110	12-44	3-8	0.8-3.2
DG 300VC	100-300	40-120	6-15	2.4-8

- Deviation from the switching point during testing pursuant to EN 1854 Gas pressure switches: ± 15%.

11.4 Cable gland set

When wiring double solenoid valve VCx 1–3, the connection boxes are to be connected using a cable gland set.

The cable gland set can only be used if the connection boxes are at the same height and on the same side and if both valves are equipped either with or without a proof of closure switch.

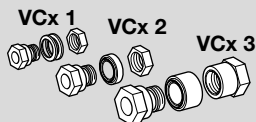

VA 1, Order No. 74921985,
VA 2, Order No. 74921986,
VA 3, Order No. 74921987.

→ We recommend preparing the connection boxes before the double solenoid valve is installed in the pipework. Alternatively, one of the actuators must be dismantled as described below and reinstalled rotated by 90° in preparation for installation of the double solenoid valve.

- 1 Disconnect the system from the electrical power supply.
- 2 Close the gas supply.

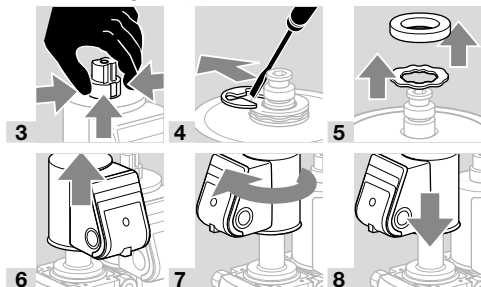

→ In both connection boxes, push through the knock-out for the cable gland set – then remove the covers. The covers must not be taken off before pushing through the knock-outs as it prevents damage to the connection boxes.

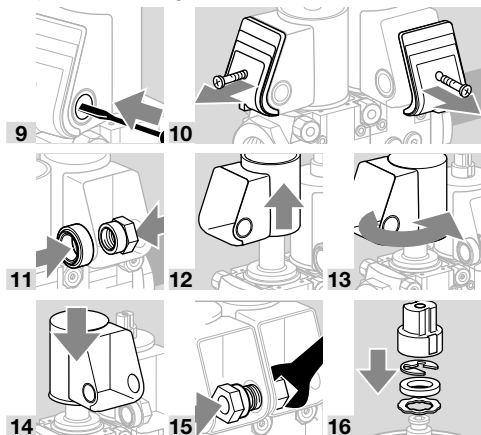

- 17 Connect the valves to the electrical power supply, see section entitled "Wiring".



18

11.5 Attachment block VA 1–3

For locked installation of pressure gauge or other accessories on the gas solenoid valve VAS 1–3.

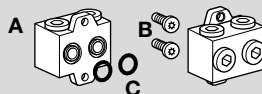

Attachment block Rp 1/4, Order No. 74922228,
Attachment block 1/4 NPT, Order No. 74926048.
Scope of delivery:

- A 1 x attachment block,
 - B 2 x self-tapping screws for installation,
 - C 2 x O-rings.
- 1 Disconnect the system from the electrical power supply.
 - 2 Close the gas supply.
- Use the enclosed self-tapping screws for installation.

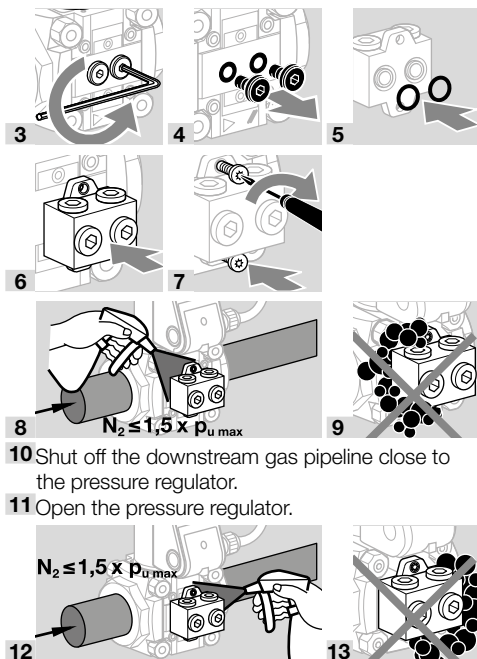

- 10 Shut off the downstream gas pipeline close to the pressure regulator.
- 11 Open the pressure regulator.

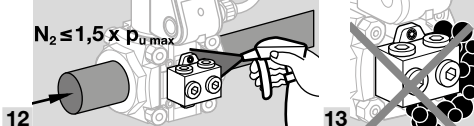

12

13

11.6 Bypass/pilot gas valves

Prepare the installed main valve.

- 1 Disconnect the system from the electrical power supply.
 - 2 Close the gas supply.
- Turn the actuator so that the side on which the bypass/pilot gas valve is to be installed is accessible.

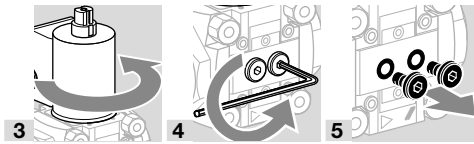

11.6.1 VB Y for V A x 1

Ambient temperature: 0 to +60°C (32 to 140°F), no condensation permitted.

Enclosure: IP 54.

Scope of delivery

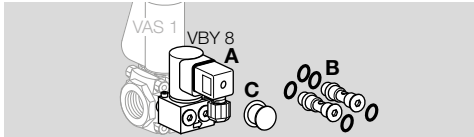

VB Y 8I as bypass valve

- A 1 x bypass valve VB Y 8I
- B 2 x retaining screws with 4 x O-rings: both retaining screws have a bypass orifice

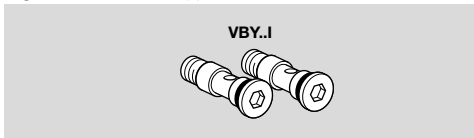

C 1 x grease for O-rings

- The screw plug at the outlet remains in place.

VB Y 8R as pilot gas valve

- A 1 x pilot gas valve VB Y 8R
- B 2 x retaining screws with 5 x O-rings: one retaining screw has a bypass orifice (2 x O-rings), the other does not (3 x O-rings)

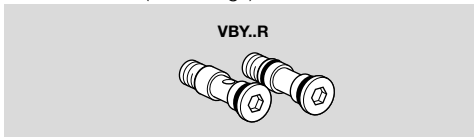

C 1 x grease for O-rings

- Remove the screw plug at the outlet and connect the Rp 1/4 pilot gas supply line.

Mounting the VB Y

- 1 Grease O-rings.

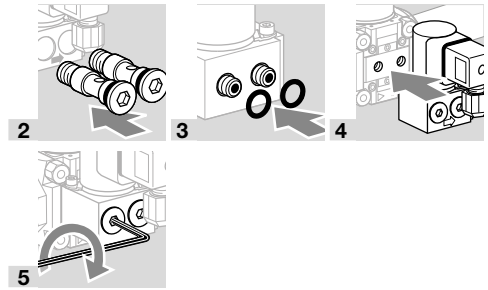

- Tighten the retaining screws alternately so that VB Y and V A x are flush.

Setting the flow rate

- The flow rate can be set by turning the flow rate restrictor (4 mm hexagon socket) 1/4 of a turn.

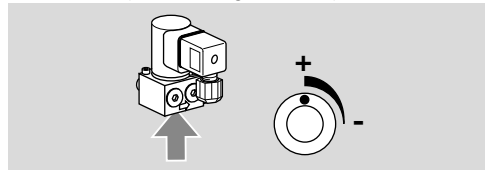

- Only adjust the flow rate restrictor in the marked range, otherwise the required gas volume will not be reached.

- 6 Wire the socket, see section entitled "Wiring".
- 7 Check for tightness, see accessories, "Checking the bypass/pilot gas valve for tightness".

11.6.2 V A S 1 for V A x 1, V A x 2, V A x 3

Scope of delivery

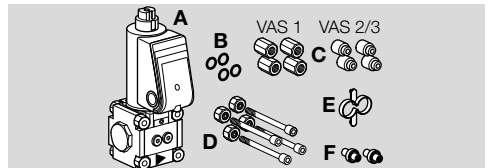

- A 1 x bypass/pilot gas valve V A S 1,
- B 4 x O-rings,
- C 4 x double nuts for V A S 1 → V A x 1,
- C 4 x spacer sleeves for V A S 1 → V A x 2/V A x 3,
- D 4 x connection parts,
- E 1 x mounting aid.

Pilot gas valve V A S 1:

- F 1 x connection pipe, 1 x sealing plug, if the pilot gas valve has a threaded flange on the outlet side.

Bypass valve V A S 1:

- F 2 x connection pipes, if the bypass valve has a blind flange on the outlet side.

Standard: Ø 10 mm.

- Always use a connection pipe F at the inlet of the main valve.

- For a bypass valve: use connection pipe F Ø 10 mm (0.39") at the outlet of the main valve if

the bypass valve's outlet flange is designed as a blind flange.

→ For the pilot gas valve: insert sealing plug **F** at the outlet of the main valve if the pilot gas valve's outlet flange is designed as a threaded flange.

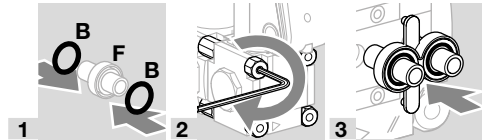

4 Remove the sealing plugs on the mounting side of the bypass valve.

Mounting the VAS 1 to VAx 1

- a** Remove the nuts from the connection parts on the mounting side of the main valve.
- b** Remove the connection parts of the bypass/pilot gas valve.
- Use the new connection parts **C** and **D** from the scope of delivery for the bypass/pilot gas valve.
- Note the recommended tightening torques for the connection parts. See page 18 (12.2.1 Tightening torque).

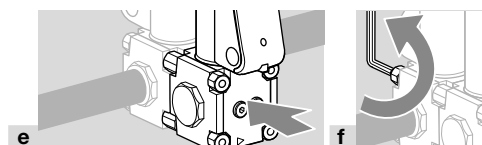
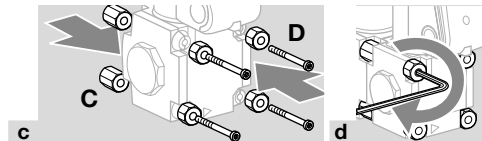

- g** Wire the bypass/pilot gas valve VAS 1, see section entitled "Wiring".
- h** Check for tightness, see accessories, "Checking the bypass/pilot gas valve for tightness".

Mounting the VAS 1 to VAx 2 or VAx 3

- The connection parts of the main valve remain mounted.
- a** Remove the connection parts of the bypass/pilot gas valve.
- b** Use the new connection parts **C** and **D** from the scope of delivery for the bypass/pilot gas valve. For VAx 2 and VAx 3, the connection parts consist of self-tapping screws.
- Note the recommended tightening torques for the connection parts. See page 18 (12.2.1 Tightening torque).

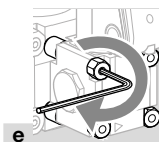
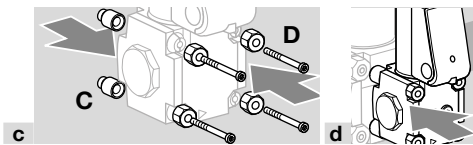

- f** Wire the bypass/pilot gas valve VAS 1, see section entitled "Wiring".
- g** Check for tightness, see accessories, "Checking the bypass/pilot gas valve for tightness".

11.6.3 Checking the bypass/pilot gas valve for tightness

- 1** To be able to check the tightness, shut off the downstream pipeline as close as possible to the valve.
- 2** Close the main valve.
- 3** Close the bypass/pilot gas valve.

⚠ CAUTION

Possible leakage!
 – If the actuator of the VB/Y is rotated, the tightness can no longer be guaranteed. To ensure that there are no leaks, check the actuator of the VB/Y for tightness.

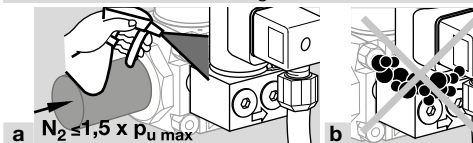

Check the bypass/pilot gas valve for tightness at the inlet and outlet.

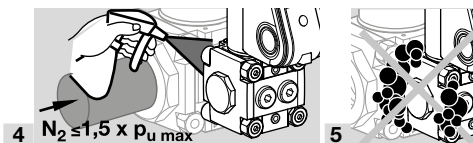

7 Open the bypass or pilot gas valve.

Bypass valve

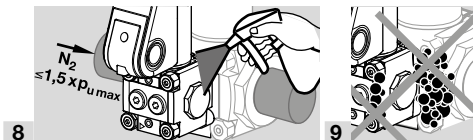

Pilot gas valve

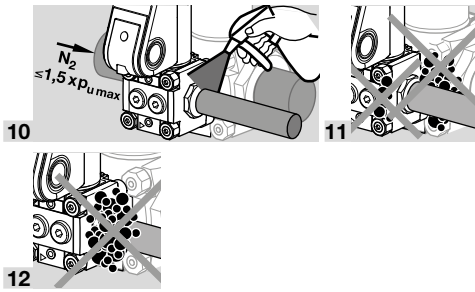

12 TECHNICAL DATA

12.1 Ambient conditions

Icing, condensation and dew in and on the unit are not permitted.

Avoid direct sunlight or radiation from red-hot surfaces on the unit. Note the maximum medium and ambient temperatures!

Avoid corrosive influences, e.g. salty ambient air or SO_2 .

The unit may only be stored/installed in enclosed rooms/buildings.

The unit is suitable for a maximum installation height of 2000 m AMSL.

Ambient temperature: -20 to $+60^\circ\text{C}$ (-4 to $+140^\circ\text{F}$), no condensation permitted.

Long-term use in the upper ambient temperature range accelerates the ageing of the elastomer materials and reduces the service life (please contact manufacturer).

Storage temperature = transport temperature: -20 to $+40^\circ\text{C}$ (-4 to $+104^\circ\text{F}$).

Enclosure: IP 65.

This unit is not suitable for cleaning with a high-pressure cleaner and/or cleaning products.

12.2 Mechanical data

Gas types: natural gas, LPG (gaseous), biogas (max. 0.1 %-by-vol. H_2S), hydrogen or clean air; other types of gas on request. The gas must be clean and dry in all temperature conditions and must not contain condensate.

Medium temperature = ambient temperature.

CE and FM approved, UL listed, max. inlet pressure p_u : 10–500 mbar (1–200 "WC).

FM approved, non operational pressure: 700 mbar (10 psig).

ANSI/CSA approved: 350 mbar (5 psig).

Opening times:

VAx../N, quick opening: ≤ 1 s,

VAx../N, quick closing: < 1 s.

Valve housing: aluminium, valve seal: NBR.

Connection flanges with internal thread: Rp to ISO 7-1, NPT to ANSI/ASME.

Safety valve:

Class A, Group 2 pursuant to EN 13611 and EN 161,

230 V AC, 120 V AC, 24 V DC:

Factory Mutual (FM) Research Class: 7400 and 7411,

ANSI Z21.21 and CSA 6.5, ANSI Z21.18 and CSA 6.3.

Turndown: up to 10:1.

Control class A to EN 88-1.

VAD

Outlet pressure p_d :

VAD..-25: 2.5–25 mbar (1–10 "WC),

VAD..-50: 20–50 mbar (8–19.7 "WC),

VAD..-100: 35–100 mbar (14–40 "WC).

Combustion chamber control pressure p_{sc} (connection p_{sa}):

-20 to $+20$ mbar (-7.8 to $+7.8$ "WC).

VAG

Outlet pressure p_d : 0.5–100 mbar (0.2–40 "WC).

Air control pressure p_{sa} : 0.5–100 mbar (0.2–40 "WC).

In applications with excess air, p_d and p_{sa} may be below the limit of 0.5 mbar. No situation which would jeopardize safety must arise. Avoid CO formation.

Adjusting range at low fire: ± 5 mbar (± 2 "WC).

Transmission ratio of gas to air: 1:1.

The inlet pressure must always be higher than the air control pressure p_{sa} + pressure loss Δp + 5 mbar (2 "WC).

Connection options for air control pressure p_{sa} :

VAG..K: 1 x 1/8" coupling for plastic hose (internal dia. 3.9 mm (0.15"), external dia. 6.1 mm (0.24")),

VAG..E: 1 x 1/8" coupling with compression fitting for 6 x 1 tube,

VAG..A: 1 x 1/8" NPT adapter,

VAG..N: zero governor with breathing orifice.

VAV

Outlet pressure p_d :

0.5–30 mbar (0.2–11.7 "WC).

Air control pressure p_{sa} :

0.4–30 mbar (0.15–11.7 "WC).

Combustion chamber control pressure p_{sc} :

-20 to $+20$ mbar (-7.8 to $+7.8$ "WC).

Min. control pressure differential $p_{sa} - p_{sc}$:

0.4 mbar (0.15 "WC).

Min. pressure differential $p_d - p_{sc}$:

0.5 mbar (0.2 "WC).

Adjusting range at low fire:

± 1.5 mbar (± 0.6 "WC).

Transmission ratio of gas to air: 0.6:1–3:1.

The inlet pressure p_u must always be higher than the air control pressure p_{sa} x transmission ratio V + pressure loss Δp + 1.5 mbar (0.6 "WC).

Connection of air control pressure p_{sa} and combustion chamber control pressure p_{sc} :

VAV..K: 2 x plastic hose couplings (internal dia.

3.9 mm (0.15"); external dia. 6.1 mm (0.24"))

or

VAV..E: 2 x 1/8" compression fittings for 6 x 1 tube

or

VAV..A: 2 x 1/8" NPT adapters.

VAH, VRH

The inlet pressure must always be higher than the differential air pressure Δp_{sa} + max. gas pressure on burner + pressure loss Δp + 5 mbar(2 "WC).

Differential air pressure Δp_{sa} ($p_{sa} - p_{sa}$) = 0.6–50 mbar (0.24–19.7 "WC).

Differential gas pressure Δp_{di} ($p_{di} - p_{di}$) = 0.6–50 mbar (0.24–19.7 "WC).

Adjusting range at low fire: ± 5 mbar (± 2 "WC).

Transmission ratio of gas to air: 1:1.

Connection of the air control pressure p_{sa} :

VAH..E, VRH..E: 3 x 1/8" couplings with compression fitting for 6 x 1 tube

or

VAH..A, VRH..A: 3 x 1/8" NPT adapters.

12.2.1 Tightening torque

Recommended tightening torques for the connection parts:

Connection parts	Tightening torque [Ncm]
VAX 1: M5	500 ± 50
VAX 2: M6	800 ± 50
VAX 3: M8	1400 ± 100

12.3 Electrical data

Mains voltage:

230 V AC, +10/-15%, 50/60 Hz;

200 V AC, +10/-15%, 50/60 Hz;

120 V AC, +10/-15%, 50/60 Hz;

100 V AC, +10/-15%, 50/60 Hz;

24 V DC, $\pm 20\%$.

Cable gland: M20 x 1.5.

Electrical connection: cable with max. 2.5 mm² (AWG 12) or plug with socket to EN 175301-803.

Duty cycle: 100%.

Power factor of the solenoid coil: $\cos \varphi = 0.9$.

Power consumption:

Type	Voltage	Power
VAX 1	24 V DC	25 W
VAX 1	100 V AC	25 W (26 VA)
VAX 1	120 V AC	25 W (26 VA)
VAX 1	200 V AC	25 W (26 VA)
VAX 1	230 V AC	25 W (26 VA)
VAX 2, VAX 3	24 V DC	36 W
VAX 2, VAX 3	100 V AC	36 W (40 VA)
VAX 2, VAX 3	120 V AC	40 W (44 VA)
VAX 2, VAX 3	200 V AC	40 W (44 VA)
VAX 2, VAX 3	230 V AC	40 W (44 VA)
VBY	24 V DC	8 W
VBY	120 V AC	8 W
VBY	230 V AC	9.5 W

Contact rating of POC/CPI:

Type	Voltage	Current (resistive load)	
		min.	max.
VAX..S, VCx..S	12–250 V AC, 50/60 Hz	100 mA	3 A
VAX..G, VCx..G	12–30 V DC	2 mA	0.1 A

Switching frequency of POC/CPI: max. 5 x per minute.

Switching current	Switching cycles*	
	$\cos \varphi = 1$	$\cos \varphi = 0.6$
0.1	500,000	500,000
0.5	300,000	250,000
1	200,000	100,000
3	100,000	–

* Limited to max. 200,000 cycles for heating systems.

13 AIR FLOW RATE Q

Air flow rate Q for a pressure loss of $\Delta p = 10$ mbar (4 "WC):

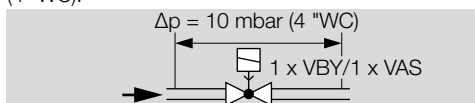

	Air flow rate	
	Q [m ³ /h]	Q [SCFH]
Bypass valve VBY	0.85	30.01
Pilot gas valve VBY	0.89	31.43

Bypass valve VAS 1: Air flow rate			
Ø [mm]	Q [m³/h]	Ø ["]	Q [m³/h]
1	0.2	0.04	7.8
2	0.5	0.08	17.7
3	0.8	0.12	28.2
4	1.5	0.16	53.1
5	2.3	0.20	81.2
6	3.1	0.24	109.5
7	3.9	0.28	137.7
8	5.1	0.31	180.1
9	6.2	0.35	218.9
10	7.2	0.39	254.2

Pilot gas valve VAS 1: Air flow rate			
Ø [mm]	Q [m³/h]	Ø ["]	Q [m³/h]
10	8.4	0.39	296.6

14 DESIGNED LIFETIME

This information on the designed lifetime is based on using the product in accordance with these operating instructions. Once the designed lifetime has been reached, safety-relevant products must be replaced.

Designed lifetime (based on date of manufacture) in accordance with EN 13611, EN 161 for VAX, VRH:

Type	Designed lifetime	
	Switching cycles	Time (years)
VAX 110 to 225	500,000	10
VAX 232 to 365	200,000	10
VRH	–	10

You can find further explanations in the applicable rules and regulations and on the afecor website (www.afecor.org).

This procedure applies to heating systems. For thermostating equipment, observe local regulations.

15 CERTIFICATION

15.1 Certificate download

Certificates – see www.docuthek.com

15.2 Declaration of conformity



We, the manufacturer, hereby declare that the products VAD/VAG/VAV/VAH/VRH 1–3 with product ID No. CE-0063BO1580 comply with the requirements of the listed Directives and Standards.

Directives:

- 2014/35/EU – LVD
- 2014/30/EU – EMC
- 2011/65/EU – RoHS II
- 2015/863/EU – RoHS III

Regulation:

- (EU) 2016/426 – GAR

Standards:

- EN 161:2022
- EN 88-1:2022+A1:2023
- EN 126:2012
- EN 1854:2022+A1:2023

The relevant product corresponds to the tested type sample.

The production is subject to the surveillance procedure pursuant to Regulation (EU) 2016/426 Annex III paragraph 3.

Elster GmbH

15.3 SIL and PL



Safety-specific characteristic values, see Safety manual/Technical Information VAD, VAG, VAV... (D, GB, F) – www.docuthek.com.

15.4 UKCA certified



Gas Appliances (Product Safety and Metrology etc. (Amendment etc.) (EU Exit) Regulations 2019)

BS EN 88-1:2011

BS EN 126:2012

BS EN 161:2011+A3:2013

15.5 VAD, VAG, VAV: FM listed

Approval does not apply for 100 V AC and 200 V AC.



Factory Mutual (FM) Research Class: 7400 and 7411 Safety overpressure slam shut valves. Designed for applications pursuant to NFPA 85 and NFPA 86.

15.6 VAD, VAG: ANSI/CSA approved

Approval does not apply for 100 V AC and 200 V AC.



Canadian Standards Association – ANSI Z21.21 and CSA 6.5

15.7 VAD, VAG, VAV (120 V AC): UL listed



Underwriters Laboratories – UL 429 “Electrically operated valves”.

15.8 VAD, VAG, VAV: AGA listed

Approval does not apply for 100 V AC and 200 V AC.



Australian Gas Association, Approval No.: 5319.

15.9 REACH Regulation

The device contains substances of very high concern which are listed in the Candidate List of the European REACH Regulation No. 1907/2006. See Reach list HTS at www.docuthek.com.

15.10 China RoHS

Directive on the restriction of the use of hazardous substances (RoHS) in China. Scan of the Disclosure Table China RoHS2, see certificates at www.docuthek.com.

16 LOGISTICS

Transport

Protect the unit from external forces (blows, shocks, vibration).

Transport temperature: see page 17 (12 Technical data).

Transport is subject to the ambient conditions described.

Report any transport damage on the unit or packaging without delay.

Check that the delivery is complete.

FOR MORE INFORMATION

The Honeywell Thermal Solutions family of products includes Honeywell Combustion Safety, Eclipse, Exothermics, Hauck, Kromschroder and Maxon. To learn more about our products, visit ThermalSolutions.honeywell.com or contact your Honeywell Sales Engineer.

Elster GmbH
Strohweg 1, D-49504 Lotte
T +49 541 1214-0
hts.lotte@honeywell.com
www.kromschroeder.com

Global centralized service deployment coordination:
T +49 541 1214-365 or -555
hts.service.germany@honeywell.com

Storage

Storage temperature: see page 17 (12 Technical data).

Storage is subject to the ambient conditions described.

Storage time: 6 months in the original packaging before using for the first time. If stored for longer than this, the overall service life will be reduced by the corresponding amount of extra storage time.

17 DISPOSAL

Devices with electronic components:

WEEE Directive 2012/19/EU – Waste Electrical and Electronic Equipment Directive



At the end of the product life (number of operating cycles reached), dispose of the packaging and product in a corresponding recycling centre. Do not dispose of the unit with the usual domestic refuse. Do not burn the product.

On request, old units may be returned carriage paid to the manufacturer in accordance with the relevant waste legislation requirements.

18 PRESSURE UNITS

mbar	Pa	kPa	"WC
1	100	0.1	0.4

