

# High-velocity burners ThermJet TJ

## ThermJet for preheated combustion air TJPCA

### TECHNICAL INFORMATION

- Fourteen sizes with capacity range 150,000 to 20,000,000 BTU/h (40 to 5333 kW)
- Turndown: 50:1
- Max. process temperature: 2800°F (1540°C)
- Low emissions
- Air and gas inlets are independently adjustable in 90° increments to suit a variety of piping alternatives
- TJPCA for use with preheated combustion air



---

# Contents

<b>Contents</b> .....	<b>2</b>	5.6.5 TJ0075, TJPCA0075.....	38
<b>1 Application</b> .....	<b>3</b>	5.6.6 TJ0100, TJPCA0100.....	39
<b>2 Certification</b> .....	<b>4</b>	5.6.7 TJ0150, TJPCA0150.....	40
2.1 Eurasian Customs Union .....	4	5.6.8 TJ0200, TJPCA0200 .....	41
<b>3 System Design</b> .....	<b>5</b>	5.6.9 TJ0300, TJPCA0300 .....	42
3.1 Burner model selection .....	5	5.6.10 TJ0500, TJPCA0500.....	43
3.1.1 Fuel Type.....	5	5.6.11 TJ0750, TJPCA0750 .....	44
3.1.2 Fuel Pressure and Combustor Type.....	5	5.6.12 TJ1000, TJPCA1000.....	45
3.2 Control methodology.....	5	5.6.13 TJ1500, TJPCA1500.....	46
3.2.1 Modulating Gas and Air .....	6	5.6.14 TJ2000, TJPCA2000.....	47
3.2.2 Modulating Gas with Fixed-Air Control.....	9	<b>5.7 Dimensions</b> .....	<b>48</b>
3.2.3 High/Low Air and Gas Control (Pulse Firing) .....	11	<b>5.8 Combustors Dimensions and Specifications.</b> .....	<b>50</b>
3.2.4 High/Low Gas with Fixed-Air Control.....	13	5.8.1 TJ/TJPCA0015–0025.....	50
3.2.5 TJPCA .....	15	5.8.2 TJ/TJPCA0040.....	51
3.3 Ignition system .....	16	5.8.3 TJ/TJPCA0050–0075.....	52
3.4 Bypass Start Gas (Optional) .....	16	5.8.4 TJ/TJPCA0100–0150.....	53
3.5 Flame monitoring system .....	19	5.8.5 TJ/TJPCA0200.....	54
3.6 Combustion Air System .....	20	5.8.6 TJ/TJPCA0300.....	55
3.6.1 Example Blower Calculation.....	21	5.8.7 TJ/TJPCA0500.....	56
3.7 Main Gas Shut-Off Valve Train.....	23	5.8.8 TJ/TJPCA0750–1000.....	57
3.8 Process Temperature Control System.....	23	5.8.9 TJ/TJPCA1500–2000.....	58
<b>4 Type code</b> .....	<b>24</b>	<b>6 Converting units</b> .....	<b>59</b>
<b>5 Technical data</b> .....	<b>26</b>	<b>7 System Schematics</b> .....	<b>60</b>
5.1 Input .....	28	<b>For more information</b> .....	<b>61</b>
5.2 Inlet pressure TJ .....	29		
5.3 Inlet pressure TJPCA.....	30		
5.4 Flame length and Velocity TJ.....	32		
5.5 Max. High Fire Visible Flame Length TJPCA .....	33		
5.6 Performance Graphs.....	33		
5.6.1 TJ0015, TJPCA0015 .....	34		
5.6.2 TJ0025, TJPCA0025 .....	35		
5.6.3 TJ0040, TJPCA0040 .....	36		
5.6.4 TJ0050, TJPCA0050 .....	37		

## 1 Application



from 250 to 750 ft/s (125 to 230 m/s) depending on the temperature of the preheated combustion air.

### TJ

The ThermJet TJ is a nozzle-mix burner that is designed to fire an intense stream of hot gases through a combustor using ambient combustion air. The high velocity of the gases improves temperature uniformity product quality and system efficiency. The ThermJet Burner comes in two types:

- High Velocity (HV) max. 500 ft/s (152 m/s)
- Medium Velocity (MV) max. 250 ft/s (125 m/s)

Flame velocity information see page 26 (5 Technical data)

### TJPCA

The ThermJet TJPCA (preheated combustion air) is a nozzle-mix burner designed to fire an intense stream of hot gases through a combustor using preheated combustion air temperatures up to 1000°F (538°C). (Models TJP-CA0500 through TJPCA1000 are rated for use with preheated combustion air temperatures up to 700°F [644°C].) The high velocity of the gases improves temperature uniformity, product quality and system efficiency. ThermJet PCA burners use medium velocity TJ combustors providing velocities

## 2 Certification

### **Declaration of Incorporation pursuant to the Machinery Directive**

The products TJ, TJPCA comply with the requirements of EN 746-2 and the Machinery Directive 2006/42/EC. This is confirmed by the manufacturer's Declaration of Incorporation.

### **2.1 Eurasian Customs Union**



The products ThermJet meet the technical specifications of the Eurasian Customs Union.

## 3 System Design

Designing a burner system is a straight-forward exercise of combining modules that add up to a reliable and safe system.

The design process is divided into the following steps:

- 1 Burner Model Selection
- 2 Control Methodology
- 3 Ignition System
- 4 Flame Monitoring System
- 5 Combustion Air System
- 6 Main Gas Shut-Off Valve Train
- 7 Process Temperature Control System

### 3.1 Burner model selection

#### Burner Size and Quantity

Select the size and number of burners based on the heat balance. For heat balance calculations, refer to the Combustion Engineering Guide (Registration required). Use the Configurator under Adlatus and also see page 26 (5 Technical data).

#### Flame Velocity

Each burner size comes in two versions, High or Medium Velocity. Select the version needed based on requirements for temperature uniformity, circulation, chamber size, air pressure and overall operating costs.

### 3.1.1 Fuel Type

Fuel	Symbol	Gross Heating Value	Specific Gravity	WOBBE Index
Natural Gas	CH <sub>4</sub> 90 %+	1000 Btu/ft <sup>3</sup> (40.1 MJ/m <sup>3</sup> )	0.60	1290 Btu/ft <sup>3</sup>
Propane	C <sub>3</sub> H <sub>8</sub>	2525 Btu/ft <sup>3</sup> (101.2 MJ/m <sup>3</sup> )	1.55	2028 Btu/ft <sup>3</sup>
Butane	C <sub>4</sub> H <sub>10</sub>	3330 Btu/ft <sup>3</sup> (133.7 MJ/m <sup>3</sup> )	2.09	2303 Btu/ft <sup>3</sup>

Btu/ft<sup>3</sup> at standard conditions (MJ/m<sup>3</sup> at normal conditions) BTU/h is based on HHV while kW is based on LHV.

If using an alternative fuel supply, contact Honeywell with an accurate breakdown of the fuel components.

### 3.1.2 Fuel Pressure and Combustor Type

The gas pressure must be at the minimum level shown. The combustor that you choose depends on the temperature and the construction of the furnace. The required gas pressure at the burner and the furnace temperature limits of the combustors can be found in page 26 (5 Technical data). The combustor that you choose depends on the temperature and the construction of the furnace.

**For tangential firing furnaces, do not use alloy combustors.**

## 3.2 Control methodology

**NOTE:** If the burner is shut off during operation at temperatures above 1000°F (538°C), provisions must be made to provide an adequate amount of flowing combustion air to keep the burner internal components cool.

The control methodology is the basis for the rest of the design process. Once it is known what the system will look like, the components that are in it can be selected. The

control methodology chosen depends on the type of process to be controlled.

**NOTE:** The stated operational characteristics only apply if the described control circuits are followed. Use of different control methods will result in unknown operational performance characteristics. Use the control circuits contained within this section or contact Honeywell for written, approved alternatives.

There are two main methods to control the input of a ThermJet system. Each of these methods also has two variants. These methods may be applied to single burner as well as multiple burner systems. The methods and variants are:

- Modulating gas and air, on-ratio control or excess air @ low fire on page 6 (3.2.1 Modulating Gas and Air).
- Modulating gas with fixed-air control on page 9 (3.2.2 Modulating Gas with Fixed-Air Control).
- High/low air and gas control (pulse firing) on page 11 (3.2.3 High/Low Air and Gas Control (Pulse Firing)).
- High/low gas with fixed-air control (Can also be used for pulse firing) on page 13 (3.2.4 High/Low Gas with Fixed-Air Control).

**NOTE:** Use of a ratio regulator in a fixed-air system is optional. However, eliminating the ratio regulator will adversely affect the ignition reliability at inputs greater than 40% of maximum.

Use of a ratio regulator in a fixed-air system also provides automatic gas modulation if system air flow changes over time (such as a clogged air filter). In the pages that follow you will find schematics of these control methods. The symbols in the schematics are explained in page 60 (7 System Schematics).

### Automatic Gas Shut-Off by Burner or Shut-Off by Zone

The automatic gas shut-off valve can be installed in two operational modes:

- 1 Automatic Gas Shut-Off by Burner**  
If the flame monitoring system detects a failure, the gas shut-off valves close the gas supply to the burner that caused the failure.
- 2 Automatic Gas Shut-Off by Zone**  
If the flame monitoring system detects a failure, the gas shut-off valves close the gas supply to all the burners in the zone that caused the failure.

**NOTE:** All ThermJet control schematics on the following pages reflect a single gas automatic shut-off valve. This may be changed to conform to local safety and/or insurance requirements. (Refer to the ThermJet Operating instructions.)

#### 3.2.1 Modulating Gas and Air

On-ratio Control or Excess Air @ Low Fire

A burner system with modulating control gives an input that is in proportion with the demands of the process. ANY input between high and low fire is possible.

- 1 Air:** The control valve **1** is in the air line. It can modulate air flow to any position between low and high fire air.
- 2 Gas:** The ratio regulator **2** allows the on-ratio amount of gas to go to the burner. Low fire gas is limited by the ratio regulator **2**. High fire gas is limited by the manual butterfly valve **3**. We recommend using a slow-opening valve as a second shut-off valve upstream of the ratio regulator.

### 3 System Design

**NOTE:** The ratio regulator can be biased to give excess air at low fire.

**NOTE:** Do not use an adjustable limiting orifice (ALO) as the high fire gas limiting valve **3**. ALO's require too much pressure drop for use in a proportional system.

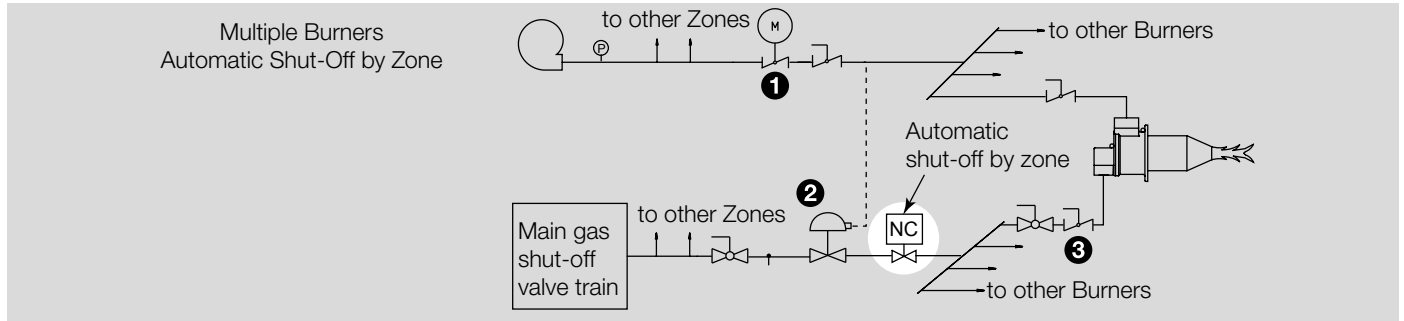
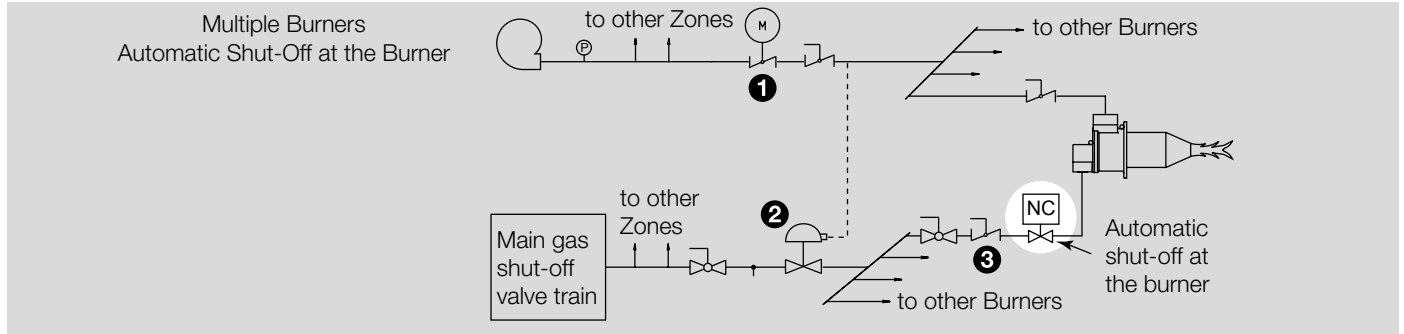

### 3 System Design

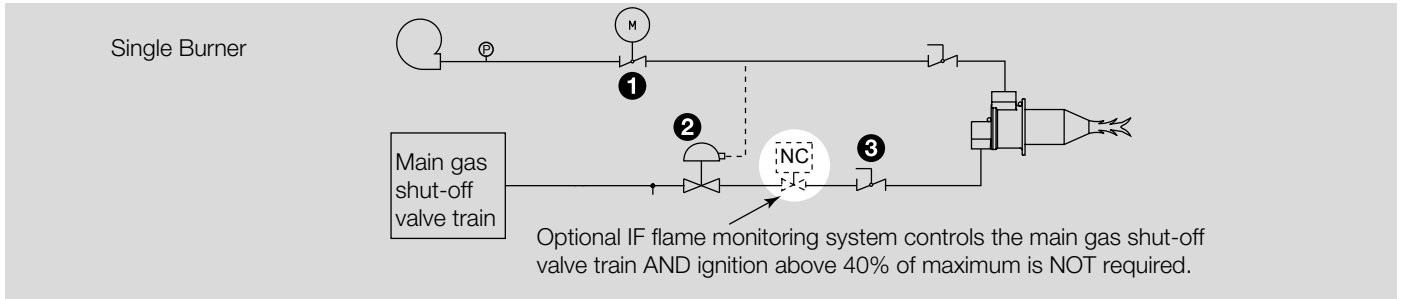

*Modulating Gas and Air (On-Ratio Control or Excess Air @ Low Fire)*



#### 3.2.2 Modulating Gas with Fixed-Air Control

A burner system with modulating control gives an input that is in proportion with the demands of the process. ANY input between high and low fire is possible.

**1 Air:** The amount of air to the burner is fixed.

**2 Gas:** The control valve **1** is in the gas line. It can modulate to any position between low and high fire.

**NOTE:** Use of a ratio regulator **2** in a fixed-air system is optional on a single burner system only. However, eliminating the ratio regulator will adversely affect the ignition reliability at inputs greater than 40% of maximum.

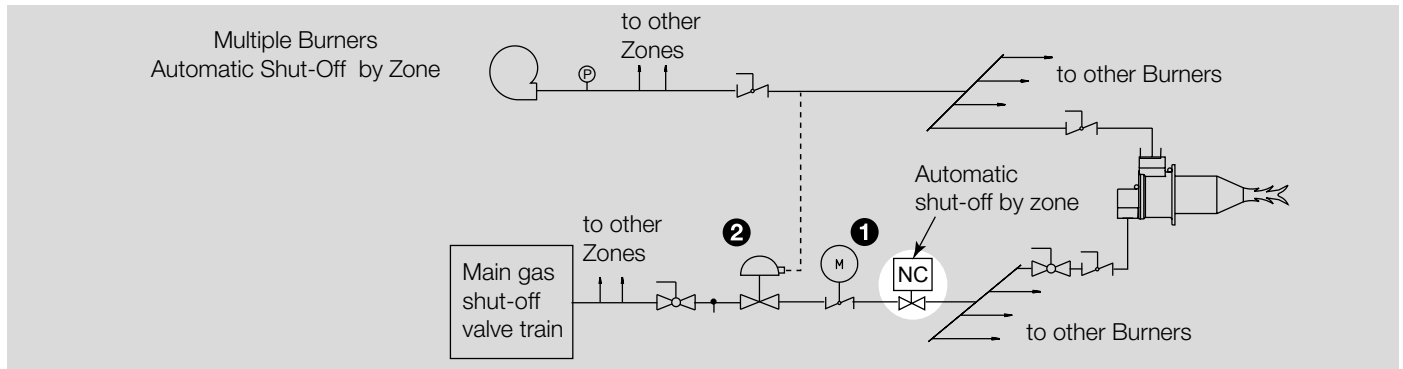
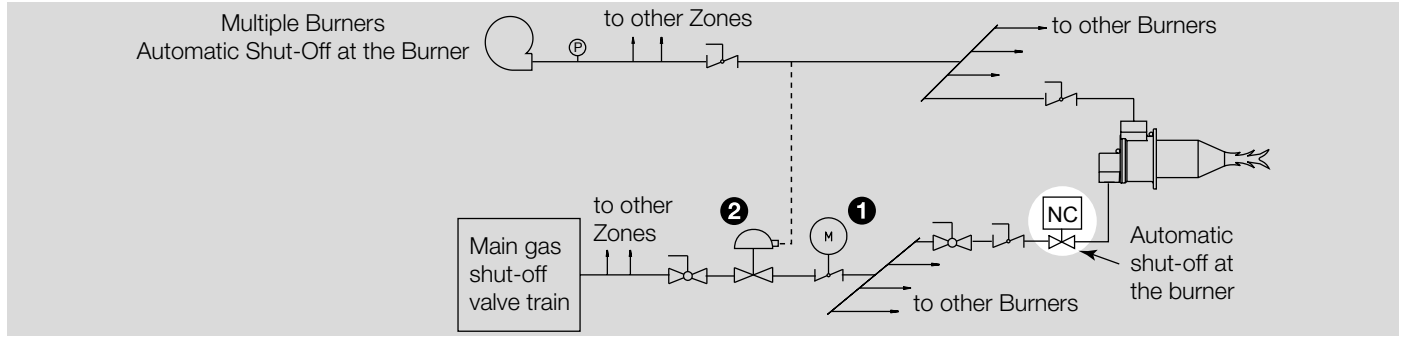

### 3 System Design

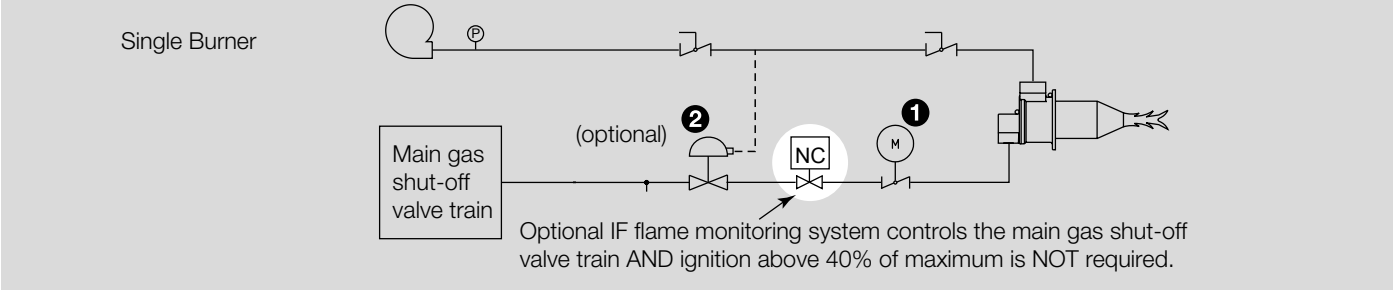

Modulating Gas with Fixed-Air Control

**3.2.3 High/Low Air and Gas Control (Pulse Firing)**

A burner system with high/low control gives a high or low fire input to the process. No input between high and low fire is possible.

- 1** Air: a. Low fire: A control input closes the solenoid valve **4**. As a result the CRS valve **5** quickly moves to low fire.

- b. High fire: A control input opens the solenoid valve **4**. As a result the CRS valve **5** quickly moves to high fire.
- 2** Gas: a. Low fire: A control input closes the solenoid valve **1**. Low fire gas passes through the butterfly valve **3**.
- b. High fire: A control input opens the solenoid valve **1**.

**NOTE:** On/off pulse control should NOT be used

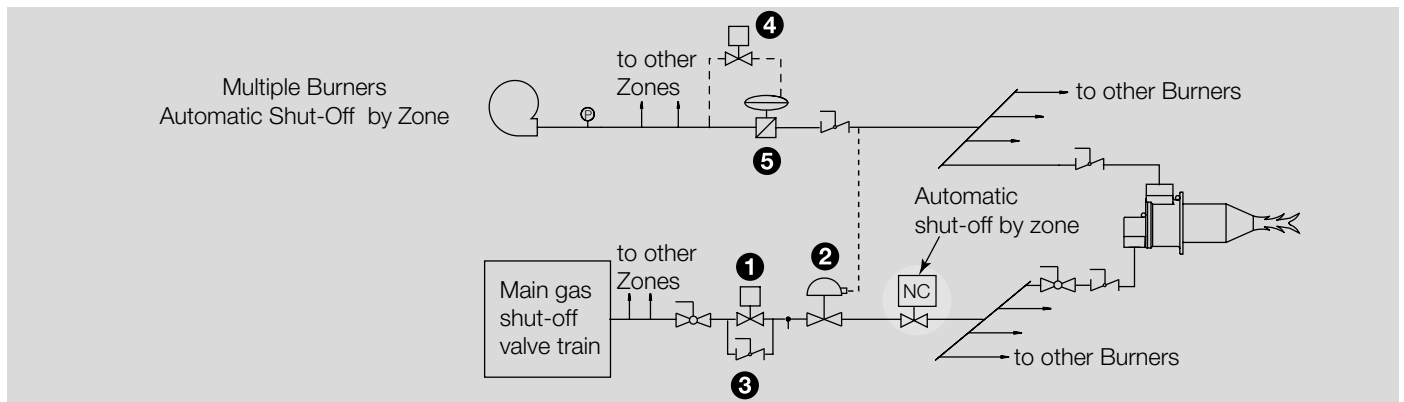
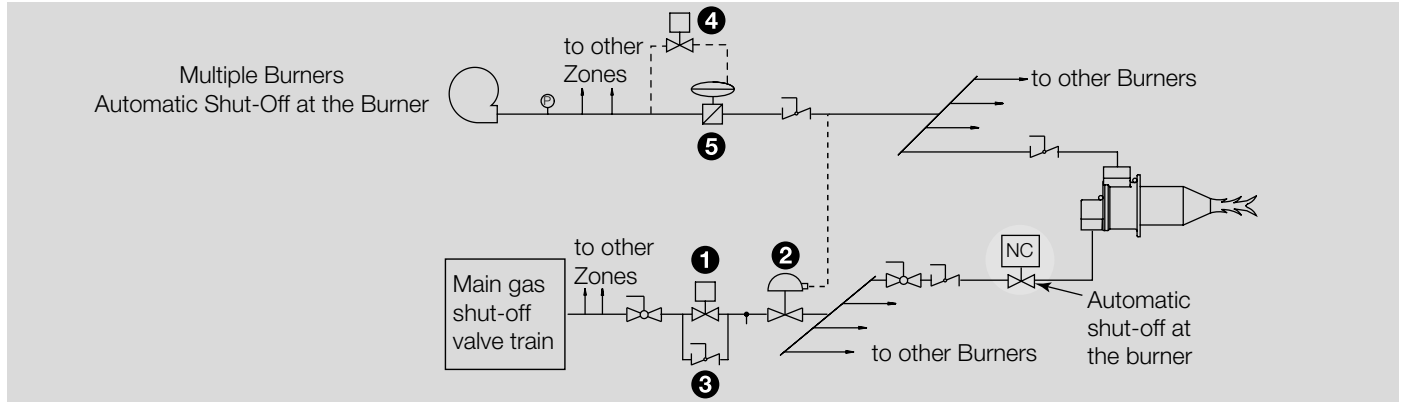

Single Burner

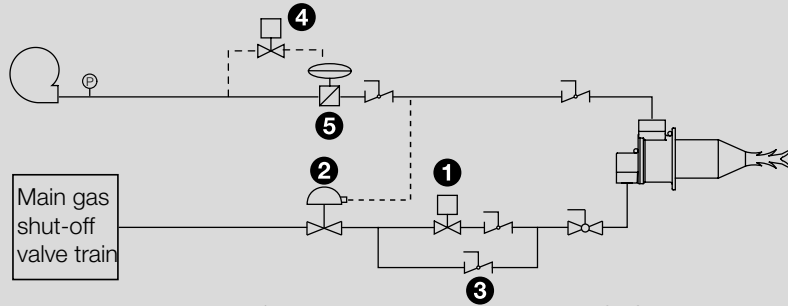

If fast high/low control is not necessary, the CRS valve can be replaced with a two-position automatic butterfly valve.

*High/Low Air & Gas Control (Pulse Firing)*

### 3 System Design

#### 3.2.4 High/Low Gas with Fixed-Air Control

(Can also be used for pulse firing.)

A burner system with high/low control gives a high or a low input to the process. NO input between high and low fire is possible.

**1** Air: The amount of air to the burner is fixed.

**2** Gas: a. Low fire: A control input closes the solenoid valve **1**. Low fire gas passes through the butterfly valve **3**.  
b. High fire: A control input opens the solenoid valve **1**. High fire gas passes through the open solenoid valve **1**.

**NOTE:** Use of a ratio regulator **2** in a fixed-air system is optional on a single burner system only. However, eliminating the ratio regulator will adversely affect the ignition reliability at inputs greater than 40% of maximum.

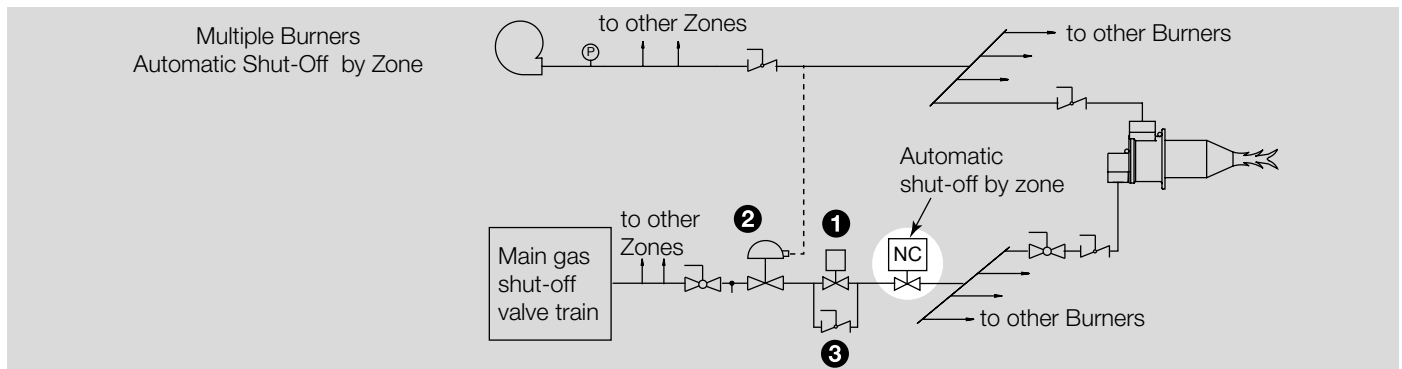
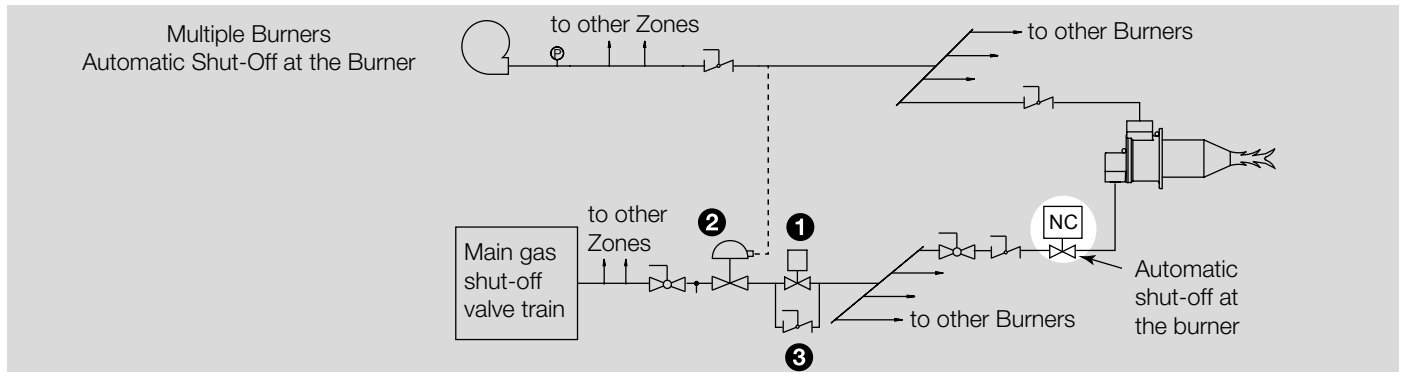

### 3 System Design

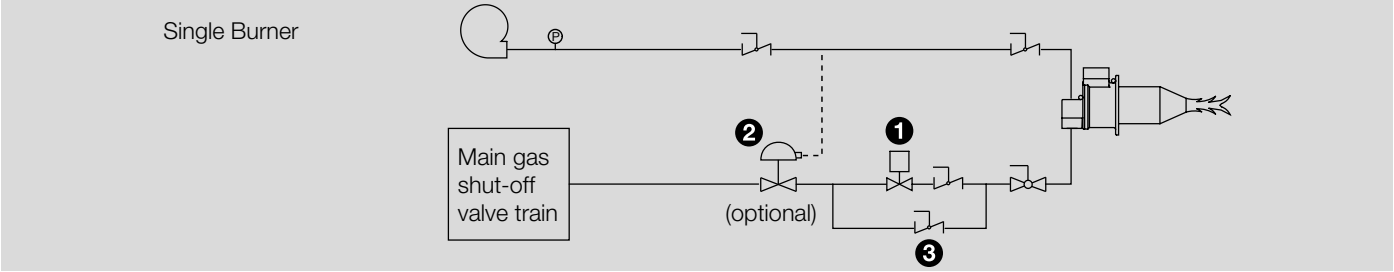

High/Low Gas with Fixed-Air Control

#### 3.2.5 TJPCA

There are four basic methods for preheated combustion air applications. All methods employ a heat exchanger and eductor per zone. They depend on how furnace pressure control and ratio control are applied:

- Furnace pressure control fixed at start up. Single diaphragm ratio regulator
- Furnace pressure control fixed at start up. Double diaphragm ratio regulator
- Automatic furnace pressure control. Double diaphragm ratio regulator
- Automatic furnace pressure control. Electronic mass ratio control

The recommended method to control the input of a ThermJet PCA burner system is modulating gas and air (onratio control or excess air at low fire). This method may be applied to single burner as well as multiple burner systems.

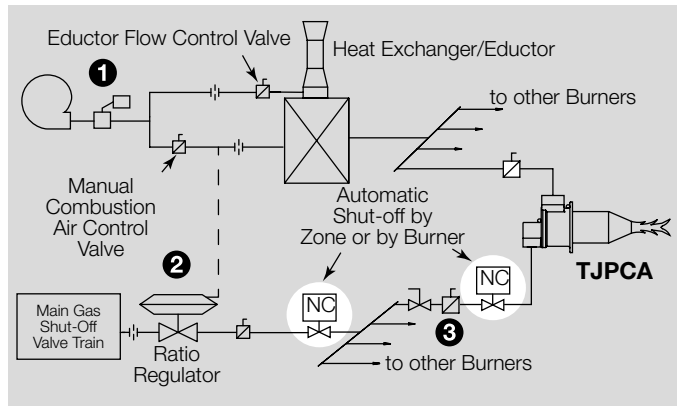

*Furnace pressure control fixed at start up. Single diaphragm ratio regulator*

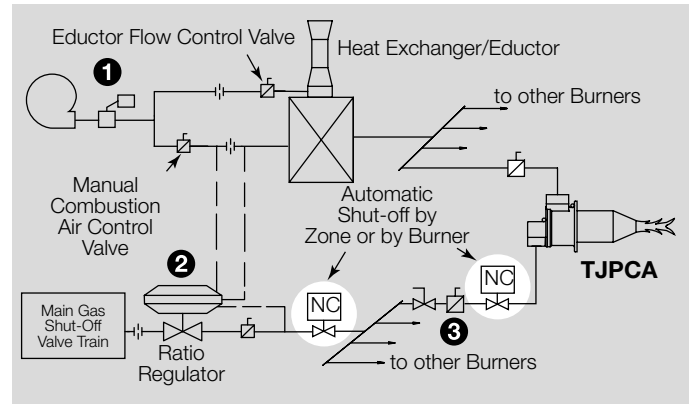

*Furnace pressure control fixed at start up. Double diaphragm ratio regulator*

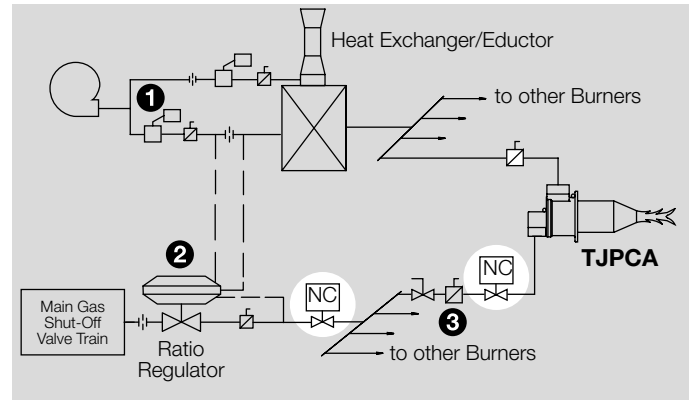

*Automatic furnace pressure control. Double diaphragm ratio regulator*

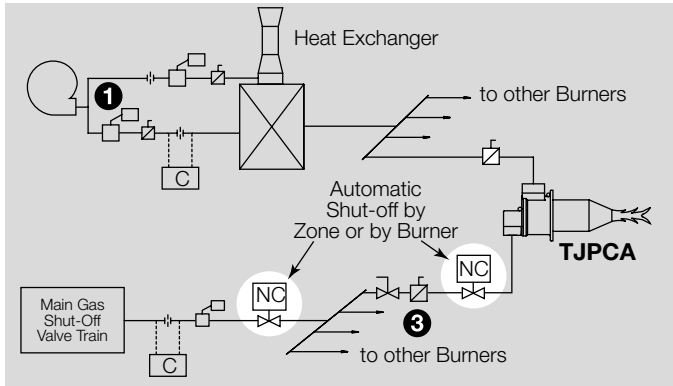

Automatic furnace pressure control. Electronic mass ratio control

### 3.3 Ignition system

#### For the ignition system you should use

- 6000 VAC transformers
- full wave spark transformers
- one transformer per burner

#### Do not use

- 10,000 VAC transformers
- twin outlet transformers
- distributor type transformers
- half wave spark transformers

It is recommended that low fire start be used, however, ThermJet burners are capable of direct spark ignition anywhere within the specified ignition zone (see page 26 (5 Technical data)).

**NOTE:** You must follow the control circuits described in the previous section, “Control Methodology,” to obtain reliable ignition.

Local safety and insurance require limits on the maximum trial for ignition time. These time limits vary from country to country. The time it takes for a burner to ignite depends on:

- The distance between the gas shut-off valve and the burner.
- The air/gas ratio.
- The gas flow at start conditions.

It is possible to have the low fire too low to ignite within the trial for ignition period. Under these circumstances you must consider the following options:

- Start at higher input levels.
- Resize and/or relocate the gas controls.
- Use bypass start gas. (See the circuit schematics)

### 3.4 Bypass Start Gas (Optional)

A bypass start gas circuit provides gas flow around zone gas control valves during the trial for ignition period. This should only be used if excess air (proportional or fixed air control) is being used on low fire; it should NOT be used with on-ratio low fire systems. During the trial for ignition period, the solenoid valve in the bypass line plus the automatic gas shut-off valve (either at each burner or each zone) are opened. If a flame is established, the bypass solenoid valve closes at the end of the trial for ignition period. If a flame is not established, then the bypass solenoid valve and the automatic gas shut-off valve close.



### 3 System Design

Modulating Gas with Fixed Air Control

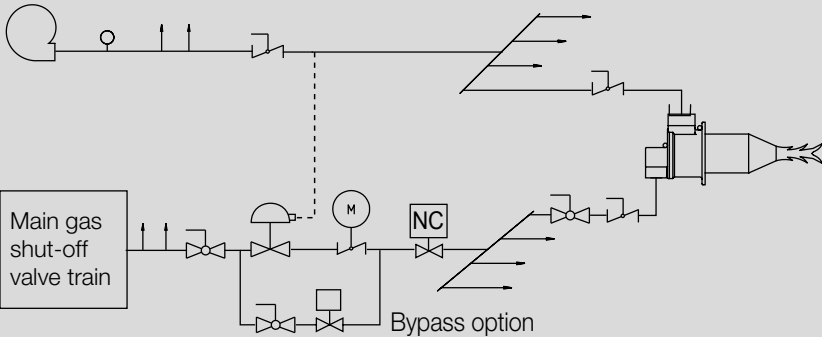

High/Low Air and Gas Control

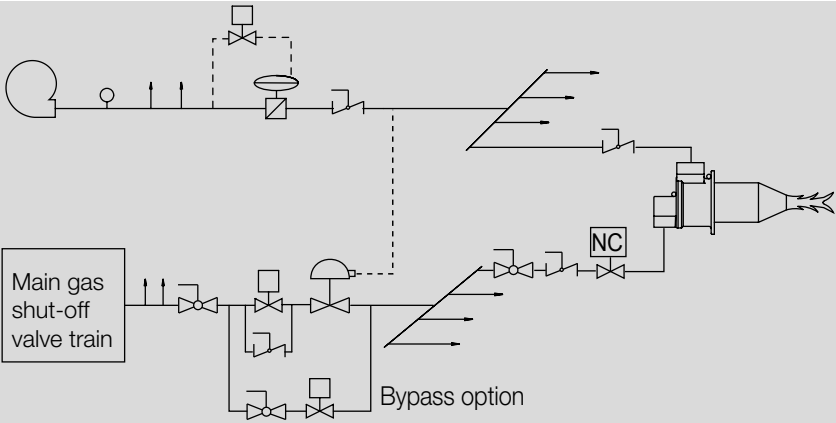

### 3 System Design

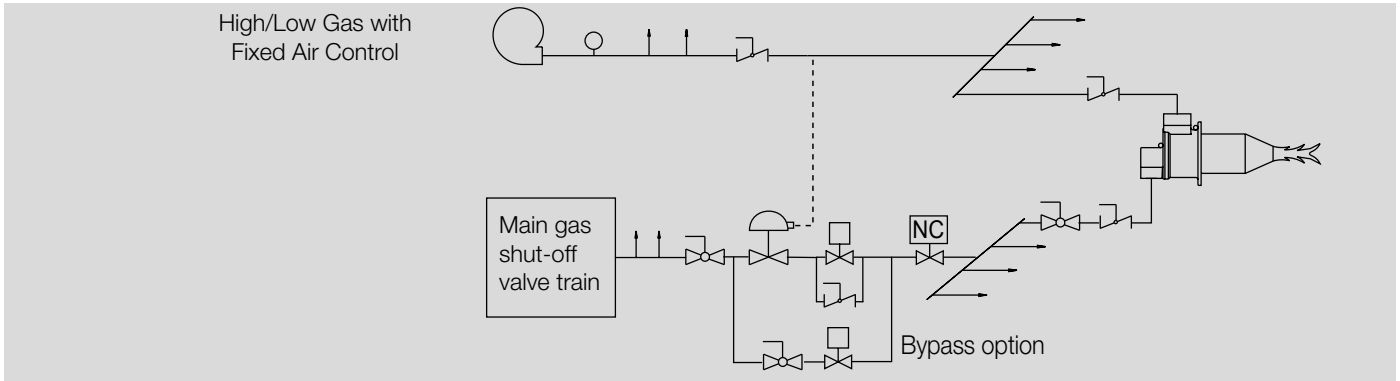

#### Bypass Start Gas Circuit Schematics

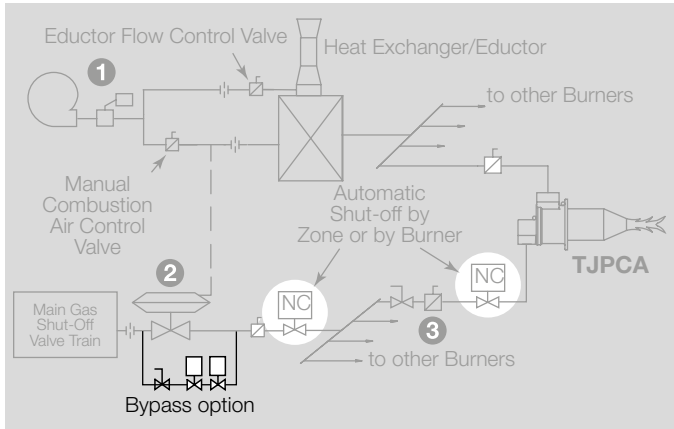

#### TJPCA Bypass Start Gas Circuit Schematics

## 3.5 Flame monitoring system

A flame monitoring system consists of two main parts:

- Flame sensor
- Flame monitoring control

### Flame sensor

There are two types that you can use for an TJ, TJPCA burner:

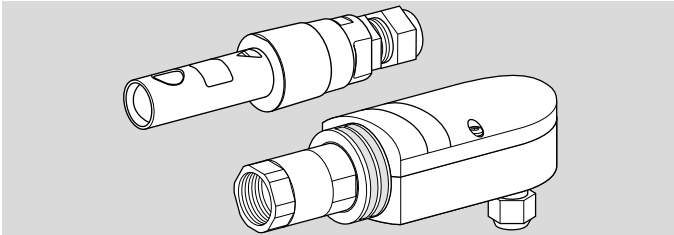

*U.V. scanner*

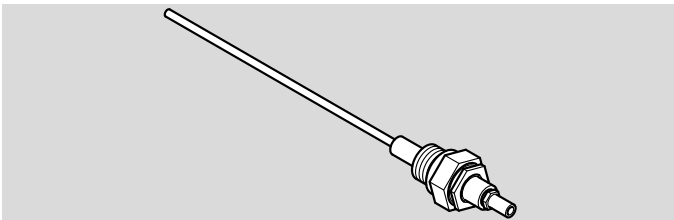

*Flame rod*

You can find UV sensor information in

- UV sensors UVS
- UV flame detector UVC for continuous operation

**NOTE:** Flame rod option is not available for the TJ0150 and larger.

### Flame Monitoring Control

The flame monitoring control is the equipment that processes the signal from the flame rod or the U.V. scanner.

For flame monitoring control you may select several options:

- Flame monitoring control for each burner: if one burner goes down, only that burner will be shut off
- Multiple burner flame monitoring control: if one burner goes down, all burners will be shut off

Honeywell recommends the following: Burner control unit BCU 400

If other controls are considered, contact Honeywell to determine how burner performance may be affected. Flame monitoring controls that have lower sensitivity flame detecting circuits may limit burner turndown and change the requirements for ignition. Flame monitoring controls that stop the spark as soon as a signal is detected may prevent establishment of flame, particularly when using UV scanners. The flame monitoring control must maintain the spark for a fixed time interval that is long enough for ignition.

DO NOT USE the following:

- Flame monitoring relays which interrupt the trial for ignition when the flame is detected
- Flame sensors which supply a weak signal
- Flame monitoring relays with low sensitivity

**NOTE:** A UV scanner can possibly detect another burner's flame if it is in the line of sight, and falsely indicate flame presence. Use a flame rod in this situation. This helps prevent accumulation of unburned fuel which, in extreme situations, could cause a fire or an explosion.

### 3.6 Combustion Air System

The blower data is based on the International Standard Atmosphere (ISA) at Mean Sea Level (MSL), which means that it is valid for:

- sea level
- 29.92 "Hg (1,013 mbar)
- 70°F (21°C)

The make-up of the air is different above sea level or in a hot area. The density of the air decreases, and as a result, the outlet pressure and the flow of the blower decrease. An accurate description of these effects is in the Combustion Engineering Guide (Registration required). The Guide contains tables to calculate the effect of pressure, altitude and temperature on air.

#### Blower

The rating of the blower must match the system requirements. You can find all the blower data in the Industrial blowers SMJ documentation.

Follow these steps:

#### 1. Calculate the outlet pressure

##### ThermJet TJ

When calculating the outlet pressure of the blower, the total of these pressures must be calculated.

- the static air pressure required at the burner
- the total pressure drop in the piping
- the total of the pressure drops across the valves
- the pressure in the chamber
- recommend a minimum safety margin of 10%

##### ThermJet Preheated Combustion Air TJPCA

**NOTE:** For a given combustion air flow, system pressure drops increase with air temperature. Multiply calculated cold air pressure drops by the appropriate factor in the chart to arrive at the preheated air drop. Formula for calculating preheated air pressure drop given a combustion air temperature:

- $h_2 = (\text{Tap}_2 / \text{Tap}_1) * h_1$
- $h_2$  = air pressure drop with preheated combustion air
- $h_1$  = air pressure drop with ambient combustion air
- $\text{Tap}_2$  = absolute temperature of preheated combustion air,  $460 + \text{PCA}^\circ\text{F}$  ( $273 + \text{PCA}^\circ\text{C}$ )
- $\text{Tap}_1$  = absolute temperature of ambient combustion air,  $460 + 60^\circ\text{F} = 520$  ( $273 + 15 = 288^\circ\text{C}$ )

##### Example Static Air Pressure Required for Preheated Combustion Air Calculation

- ambient air temperature: 60°F
- preheated combustion air temperature: 700°F
- burner size: TJPCA0075  
 $\text{Tabs}_1 = 60 + 460 = 520$   
 $\text{Tabs}_2 = 700 + 460 = 1160$   
 $h_1$  = For ambient air pressure drop see page 30 (5.3 Inlet pressure TJPCA). In this example the ambient air requirement is 3.8"w.c.  
 $h_2 = (1160/520) * 3.8 = 8.5"$  w.c.

The air pressure required to the inlet of the burner is 8.5" w.c.

#### Common Preheated Air Pressure Drop Correction Factors

If combustion air temperature is	Multiply 60°F drop by
400°F	1.65
600°F	2.04
800°F	2.42
1000°F	2.81

When calculating the outlet pressure of the blower, the total of these pressures must be calculated.

- The static air pressure required at the burner see page 30 (5.3 Inlet pressure TJPCA) (see example above)
- The total pressure drop in the piping
- The total of the pressure drops across the valves
- The pressure in the chamber (suction or pressurized)

Honeywell recommends a minimum safety margin of 10%.

#### 2. Calculate the required flow

The blower output is the air flow delivered under standard atmospheric conditions. It must be enough to feed all the burners in the system at high fire.

Combustion air blowers are normally rated in terms of standard cubic feet per hour (scfh) of air.

An example calculation follows the information tables below:

#### Required Calculation Information

Description	Unit of Measure	Formula Symbol
Total system heat input	Btu/h	Q
Number of burners	–	
Type of fuel	–	
Gross heating value of fuel	Btu/ft <sup>3</sup>	q

Description	Unit of Measure	Formula Symbol
Desired excess air percentage (Typical excess air percentage @ high fire is 15%)	percent	%
Air/Gas ratio (Fuel specific, see table below)	–	$\alpha$
Air flow	scfh	$V_{air}$
Gas flow	scfh	$V_{gas}$

#### Fuel Gas Heating Values

Fuel Gas	Stoichiometric* Air/Gas Ratio $\alpha$ (ft <sup>3</sup> <sub>air</sub> /ft <sup>3</sup> <sub>gas</sub> )	Gross Heating Value q (Btu/ft <sup>3</sup> )
Natural Gas (Birmingham, AL)	9.41/1	1002
Propane	23.82/1	2572
Butane	30.47/1	3225

\* Stoichiometric: No excess air: The precise amount of air and gas are present for complete combustion.

#### 3.6.1 Example Blower Calculation

A batch furnace requires a gross heat input of 2,900,000 Btu/hr (based on 45% efficiency). The designer decides to provide the required heat input with four burners operating on natural gas using 15% excess air.

##### a. Decide which TJ, TJPCA model is appropriate

$Q_{total}$  of 2,900,000 BTU/h / 4 burners = 725,000 Btu/h per burner

Select 4 model TJ0075 ThermJet burners based on the required heat input of 725,000 Btu/h for each burner.

##### b. Calculate the required gas flow

$V_{gas} = Q/q = 725,000 \text{ Btu/h} / 1,002 \text{ Btu/ft}^3 = 2,894 \text{ ft}^3/\text{h}$   
 Gas flow of 2,894 ft<sup>3</sup>/hr is required.

#### c. Calculate the required stoichiometric air flow

$$V_{\text{air-stoichiometric}} = \alpha (\text{air/gas ratio}) \times V_{\text{gas}} = 9.41 \times 2,894 \text{ ft}^3/\text{h} = 27,235 \text{ ft}^3/\text{h}$$

Stoichiometric air flow of 27,235 scfh required

#### d. Calculate the final blower air flow requirement based on 15% excess air at high fire

$$V_{\text{air}} = (1 + \text{excess air \%}) \times V_{\text{air-stoichiometric}} = (1 + 0.15) \times 27,235 \text{ ft}^3/\text{h} = 31,320 \text{ ft}^3/\text{h}$$

For this example, final blower air flow requirement is 31,320 scfh at 15% excess air.

#### e. For TJPCA calculate eductor flow. For this example, eductor flow is 40% of combustion air flow

$$V_{\text{eductor}} = 0.4 \times 31,320 \text{ ft}^3/\text{h} = 12,528 \text{ ft}^3/\text{h}$$

Final blower air flow requirement is the sum of  $V_{\text{air}} + V_{\text{eductor}} = 43,848 \text{ ft}^3/\text{h}$  at 15% excess air

**NOTE:** It is common practice to add an additional 10% to the final blower air flow requirement as a safety margin.

#### 3. Find the blower model number and motor horsepower (hp).

With the output pressure and the specific flow, you can find the blower catalog number and the motor hp in Bulletin 610.

#### 4. Honeywell recommends that you select a totally enclosed fan cooled (TEFC) motor.

#### 5. Select the other parameters

- inlet filter or inlet grille
- inlet size (frame size)
- voltage, number of phases, frequency
- blower outlet location, and rotation direction Clockwise (CW) or Counter Clockwise (CCW)

**NOTE:** The use of an inlet air filter is strongly recommended. The system will perform longer and the settings will be more stable.

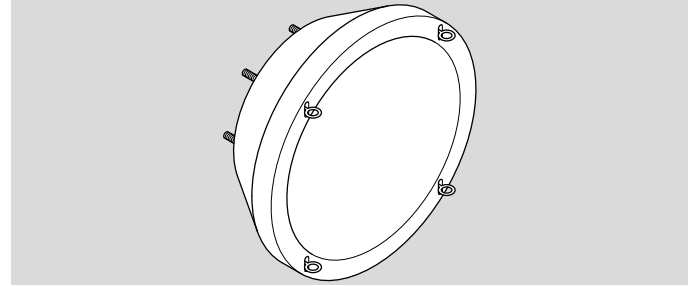

*Inlet filter with replaceable filter element*

**NOTE:** When selecting a 60 Hz blower for use on 50 Hz, a pressure and capacity calculation is required. See Combustion Engineering Guide (Registration required).

The total selection information you should now have:

- blower model number
- motor hp
- motor enclosure (TEFC)
- voltage, number of phases, frequency
- rotation direction (CW or CCW).

#### Air pressure switch

The air pressure switch gives a signal to the monitoring system when there is not enough air pressure from the blower.

You can find more information on pressure switches in Blower Bulletin 610.

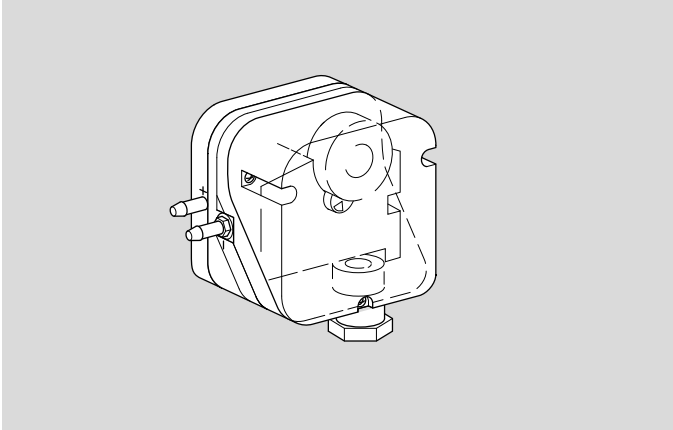

Honeywell supports NFPA and EN regulations, which require the use of an air pressure switch in conjunction with other safety components, as a minimum standard for main gas safety shut-off systems.

### 3.7 Main Gas Shut-Off Valve Train

#### Consult Honeywell

Honeywell can help you design and obtain a main gas shut-off valve train that complies with the current safety standards.

The shut-off valve train must comply with all the local safety standards set by the authorities that have jurisdiction.

For details, please contact your local Honeywell representative.

**NOTE:** Honeywell Combustion supports NFPA regulations (two shut-off valves) as a minimum standard for main gas safety shut-off systems.



### 3.8 Process Temperature Control System

#### Consult Honeywell

The process temperature control system is used to control and monitor the temperature of the system. There is a wide variety of control and measuring equipment available.

For details, please contact your local Honeywell representative.

## 4 Type code

<b>TJ</b>	High-velocity burner
	<b>Rated capacity</b>
<b>0015</b>	150 000 Btu/h (40 kW)
<b>0025</b>	250 000 Btu/h (67 kW)
<b>0040</b>	400 000 Btu/h (107 kW)
<b>0050</b>	500 000 Btu/h (133 kW)
<b>0075</b>	750 000 Btu/h (200 kW)
<b>0100</b>	1 000 000 Btu/h (267 kW)
<b>0150</b>	1 500 000 Btu/h (400 kW)
<b>0200</b>	2 000 000 Btu/h (586 kW)
<b>0300</b>	3 000 000 Btu/h (800 kW)
<b>0500</b>	5 000 000 Btu/h (1 333 kW)
<b>0750</b>	7 500 000 Btu/h (2 000 kW)
<b>1000</b>	10 000 000 Btu/h (2 666 kW)
<b>1500</b>	15 000 000 Btu/h (4 000 kW)
<b>2000</b>	20 000 000 Btu/h (5 333 kW)

	<b>Preheat temperature</b>
<b>A</b>	No preheat ambient
<b>B</b>	Preheat ambient to 300 °F (150 °C)
<b>C</b>	Preheat ambient to 300–700 °F (150–370 °C)
<b>D</b>	Preheat ambient to 700–1000 °F (370–540 °C)

	<b>Furnace temperature</b>
<b>1</b>	<1750 °F (950 °C)
<b>2</b>	1750–2500 °F (950–1370 °C)
<b>3</b>	2500–2800 °F (1370–1540 °C)
<b>4</b>	1750–2200 °F (950–1200 °C)

**5** 2200–2800 °F (1200–1540 °C)

	<b>Firing position</b>
<b>A</b>	Horizontal or vertical up
<b>D</b>	Vertical Down

	<b>Flame velocity</b>
<b>H</b>	High velocity outlet
<b>M</b>	Medium velocity outlet

	<b>Combustor type</b>
<b>AT</b>	Alloy tube
<b>BD</b>	Down firing block and holder
<b>BH</b>	Block and holder
<b>SC</b>	Silicon carbide

	<b>Gas type</b>
<b>B</b>	Butane
<b>N</b>	Natural gas
<b>P</b>	Propane

	<b>Gas orifice</b>
<b>A4</b>	5.5 mm
<b>A6</b>	7.0 mm
<b>A8</b>	9.0 mm
<b>A9</b>	9.1 mm
<b>B1</b>	10.0 mm
<b>B2</b>	10.8 mm
<b>B7</b>	13.0 mm
<b>C2</b>	16.0 mm
<b>C4</b>	18.0 mm
<b>C6</b>	20.0 mm
<b>C8</b>	22.5 mm



#### 4 Type code

<b>D1</b>	24.0 mm	<b>J1</b>	222.3 mm x 152.3 mm
<b>D2</b>	29.0 mm	<b>J2</b>	232.1 mm x 162.1 mm
<b>D5</b>	37.0 mm	<b>XX</b>	No
<b>D6</b>	42.0 mm	<b>Flame control</b>	
<b>F2</b>	11.5 mm	<b>F</b>	Ionization
<b>F3</b>	8.5 mm	<b>U</b>	Extended 1" UV scanner adapter only
<b>F4</b>	8.0 mm	<b>V</b>	Extended 3/4" UV scanner adapter only
<b>F5</b>	13.5 mm	<b>W</b>	3/4" UV scanner adapter only
<b>G1</b>	45.0 mm	<b>X</b>	1/2" UV scanner adapter only
<b>G2</b>	52.0 mm	<b>Nozzle material</b>	
<b>G3</b>	25.0 mm	<b>A</b>	Stainless nozzle
<b>G4</b>	28.0 mm	<b>B</b>	Stainless nozzle for flame rod and block
<b>G6</b>	33.0 mm	<b>F</b>	Standard nozzle for flame rod and block
<b>G7</b>	60.0 mm	<b>S</b>	Standard nozzle
<b>G8</b>	65.0 mm	<b>Pipe connection</b>	
	<b>Air orifice</b>	<b>B</b>	BSP (Rc)
<b>C9</b>	23.0 mm	<b>N</b>	NPT
<b>D2</b>	29.0 mm	<b>P</b>	Air: flanged, gas: NPT
<b>D5</b>	37.0 mm	<b>R</b>	Air: flanged, gas: BSP (Rc)
<b>D6</b>	42.0 mm	<b>Y</b>	Air: welded, gas: BSP (Rc)
<b>D9</b>	49.0 mm	<b>Z</b>	Air: welded, gas: NPT
<b>E2</b>	57.0 mm	<b>Gas orientation</b>	
<b>E6</b>	66.0 mm	<b>0</b>	Gas inlet at 0° (CW) with air inlet at 0°
<b>E7</b>	70.0 mm	<b>1</b>	Gas inlet at 90° (CW) with air inlet at 0°
<b>E8</b>	90.0 mm	<b>2</b>	Gas inlet at 180° (CW) with air inlet at 0°
<b>F1</b>	125.0 mm	<b>3</b>	Gas inlet at 270° (CW) with air inlet at 0°
<b>H1</b>	150.0 mm		
<b>H2</b>	155.0 mm		

## 5 Technical data

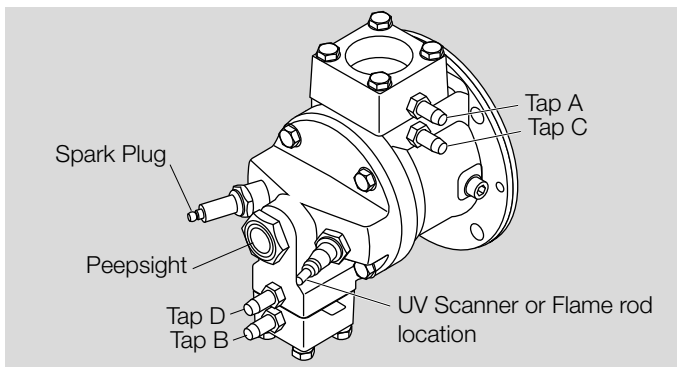

TJ0015-0025, TJPCA0015-0025

Only the TJ0015, TJ0025, and TJ0040 have the spark plug on the left.

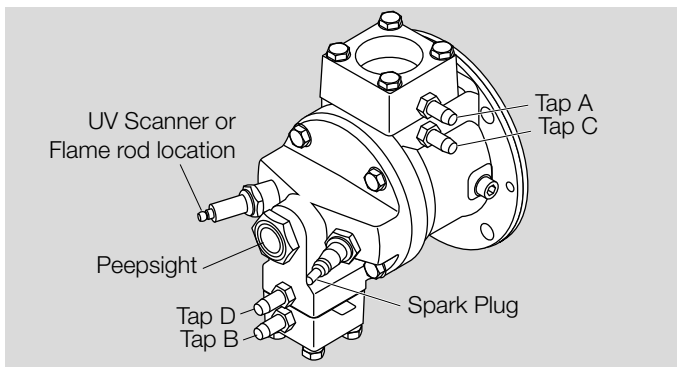

TJ0040-0200, TJPCA0040-0200

TJ0150 and TJ0200 can not be used with flame rod.

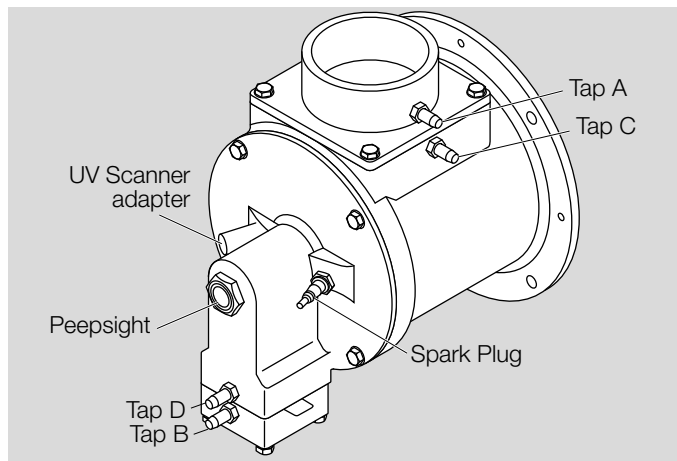

TJ0300-1000, TJPCA0300-1000

## 5 Technical data

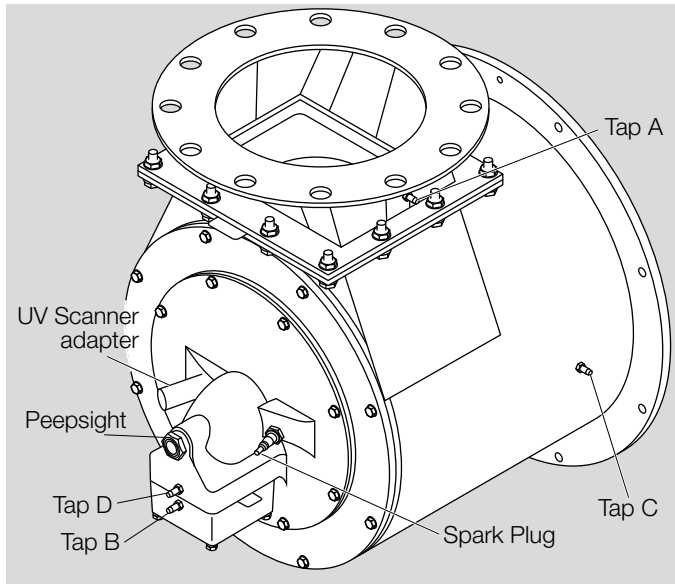

TJPCA: UV scanners available for all combustors (no flame rods).

*TJ1500–2000, TJPCA1500–2000*

Pressure tap A only available with TJ (not TJPCA).

Type of gas: Natural gas, Propane or Butane, For any other mixed gas, contact Honeywell.

Maximum Combustion Air Temperature: 300°F (149°C). For higher temperatures use TJPCA.

Flame Detection:

TJ0015–0100: Flame rods can be used with all combustors, any fuel listed below, and operating temperatures up to 2,200°F (1,204°C). UV scanners can be used with all combustors, any fuel listed below, and up to the maximum operating temperature.

TJ0150–2000: UV scanners can be used with all combustors.

## 5.1 Input

Type	Maximum, Btu/h (kW) <sup>1</sup>	Minimum, Btu/h (kW) <sup>1</sup>	TJ only: Minimum, Fixed Air, Btu/h (kW) <sup>1</sup>
Medium & High Velocity			
TJ0015/TJPCA0015	150,000 (40)	15,000 (4)	3,750 (1)
TJ0025/TJPCA0025	250,000 (67)	25,000 (7)	6,250 (2)
TJ0040/TJPCA0040	400,000 (107)	40,000 (11)	10,000 (3)
TJ0050/TJPCA0050	500,000 (133)	50,000 (13)	10,000 (3)
TJ0075/TJPCA0075	750,000 (200)	75,000 (20)	15,000 (4)
TJ0100/TJPCA0100	1,000,000 (267)	100,000 (26)	20,000 (5)
TJ0150/TJPCA0150	1,500,000 (400)	150,000 (40)	30,000 (8)
TJ0200/TJPCA0200	2,000,000 (533)	200,000 (53)	40,000 (11)
TJ0300/TJPCA0300	3,000,000 (800)	300,000 (79)	60,000 (16)
TJ0500/TJPCA0500	5,000,000 (1333)	500,000 (132)	100,000 (26)
TJ0750/TJPCA0750	7,500,000 (1983)	750,000 (198)	150,000 (40)
TJ1000/TJPCA1000	10,000,000 (2666)	1,000,000 (264)	200,000 (53)
TJ1500/TJPCA1500	15,000,000 (4000)	1,500,000 (396)	300,000 (79)
TJ2000/TJPCA2000	20,000,000 (5333)	2,000,000 (528)	400,000 (106)

<sup>1</sup> All imperial inputs based upon gross calorific values (HHV). All metric inputs based upon net calorific values (LHV). For lower inputs, contact Honeywell Eclipse.

## 5.2 Inlet pressure TJ

Type	Main Gas, "w.c. (mbar), measured at Tap B						Air, "w.c. (mbar) measured at Tap A <sup>1</sup>					
	High Velocity			Medium Velocity			High Velocity			Medium Velocity		
	Natural Gas	Propane	Butane	Natural Gas	Propane	Butane	Natural Gas	Propane	Butane	Natural Gas	Propane	Butane
TJ0015	13.0 (32.4)	15.0 (37.4)	15.0 (37.4)	7.5 (18.7)	7.5 (18.7)	7.5 (18.7)	17.0 (42.3)	18.0 (44.8)	18.0 (44.8)	11.0 (27.4)	11.0 (27.4)	11.0 (27.4)
TJ0025	14.0 (34.9)	15.0 (37.3)	15.0 (37.3)	6.8 (16.9)	7.4 (18.4)	7.0 (17.4)	17.0 (42.3)	18.0 (44.8)	18.0 (44.8)	10.0 (24.9)	10.0 (24.9)	10.0 (24.9)
TJ0040	12.0 (29.9)	13.0 (32.4)	12.0 (29.9)	5.5 (13.7)	5.5 (13.7)	5.0 (12.5)	15.5 (38.6)	17.0 (42.3)	17.0 (42.3)	9.0 (22.4)	9.5 (23.7)	9.5 (23.7)
TJ0050	16.2 (40.3)	19.6 (48.8)	17.1 (42.6)	8.9 (22.2)	11.4 (28.4)	9.6 (23.9)	16.7 (41.6)	18.0 (44.8)	17.4 (43.3)	9.9 (24.6)	10.9 (27.1)	10.5 (26.1)
TJ0075	13.8 (34.4)	18.3 (45.6)	17.4 (43.3)	7.2 (17.9)	10.2 (25.4)	9.7 (24.1)	16.0 (39.8)	16.9 (42.1)	17.0 (42.3)	9.0 (22.4)	9.3 (23.2)	9.5 (23.7)
TJ0100	12.5 (31.0)	13.5 (34.0)	14.5 (36.0)	5.5 (14.0)	8.0 (20.0)	7.5 (19.0)	16.5 (41.0)	17.0 (43.0)	17.0 (43.0)	9.0 (23.0)	9.0 (23.0)	9.0 (23.0)
TJ0150	14.5 (36.0)	15.0 (38.0)	15.5 (39.0)	7.0 (17.5)	6.0 (15.0)	6.5 (16.0)	17.5 (44.0)	19.5 (49.0)	19.5 (49.0)	9.5 (24.0)	10.0 (25.0)	10.5 (26.0)
TJ0200	9.3 (23.0)	12.7 (32.0)	13.4 (34.0)	7.1 (18.0)	8.5 (21.0)	6.9 (17.0)	12.3 (31.0)	14.1 (35.0)	14.1 (35.0)	10.0 (25.0)	11.0 (28.0)	11.0 (28.0)
TJ0300	12.5 (31.0)	12.7 (32.0)	12.2 (30.0)	6.0 (15.0)	6.8 (17.0)	6.0 (15.0)	15.0 (38.0)	15.0 (38.0)	15.0 (38.0)	8.5 (21.0)	8.5 (21.0)	8.5 (21.0)
TJ0500	13.5 (34.0)	14.0 (35.0)	13.0 (33.0)	5.5 (14.0)	6.0 (15.0)	5.5 (14.0)	18.5 (46.0)	17.5 (44.0)	17.5 (44.0)	10.0 (25.0)	10.0 (25.0)	10.0 (25.0)
TJ0750	13.4 (33.4)	13.4 (33.4)	13.4 (33.4)	6.7 (16.7)	6.7 (16.7)	6.7 (16.7)	16.6 (41.3)	16.6 (41.3)	16.6 (41.3)	10.2 (25.4)	10.2 (25.4)	10.2 (25.4)
TJ1000	14.2 (35.4)	14.2 (35.4)	14.2 (35.4)	5.5 (13.7)	5.5 (13.7)	5.5 (13.7)	16.7 (41.6)	16.7 (41.6)	16.7 (41.6)	7.8 (19.4)	7.8 (19.4)	7.8 (19.4)
TJ1500	15.7 (39.1)	15.7 (39.1)	15.7 (39.1)	3.7 (9.2)	3.7 (9.2)	3.7 (9.2)	19.7 (49.1)	19.7 (49.1)	19.7 (49.1)	8.4 (20.9)	8.4 (20.9)	8.4 (20.9)
TJ2000	13.5 (33.6)	13.5 (33.6)	13.5 (33.6)	3.6 (9)	3.6 (9)	3.6 (9)	21.0 (52.5)	21.0 (52.5)	21.0 (52.5)	11.5 (29)	11.5 (29)	11.5 (29)

<sup>1</sup> 15% excess air at maximum input

## 5.3 Inlet pressure TJPCA

### Natural Gas

Type	Main Gas, "w.c. (mbar), measured at Tap B				Air, "w.c. (mbar), measured at Tap A			
	Combustion Air Temperature							
	Ambient	300°F (150°C)	700°F (370°C)	1000°F (540°C)	Ambient	300°F (150°C)	700°F (370°C)	1000°F (540°C)
TJPCA0015	7.5 (18.6)	9.8 (24.4)	14.0 (34.9)	17.2 (42.7)	3.5 (8.7)	5 (12.5)	7.7 (19.2)	9.6 (23.9)
TJPCA0025	6.8 (16.9)	8.8 (21.9)	12.5 (31.1)	15.3 (38.0)	6.3 (15.7)	9.1 (22.7)	13.8 (34.4)	17.4 (43.3)
TJPCA0040	5.5 (13.7)	7.2 (17.9)	10.3 (25.6)	12.7 (31.4)	3.4 (8.5)	4.9 (12.2)	7.4 (18.4)	9.4 (23.4)
TJPCA0050	8.9 (22.1)	10.9 (27.0)	14.4 (35.8)	17.1 (42.4)	5.2 (13)	7.5 (18.7)	11.4 (28.4)	14.3 (35.6)
TJPCA0075	7.2 (17.9)	8.4 (20.8)	10.5 (26.1)	12.1 (30.1)	3.8 (9.5)	5.4 (13.5)	8.3 (20.7)	10.5 (26.2)
TJPCA0100	5.5 (13.7)	6.7 (16.7)	8.9 (22.2)	10.6 (26.3)	3.5 (8.7)	5 (12.5)	7.7 (19.2)	9.6 (23.9)
TJPCA0150	7.0 (17.4)	8.3 (20.7)	10.8 (26.8)	12.6 (31.3)	4.5 (11.2)	6.5 (16.2)	9.8 (24.4)	12.4 (30.9)
TJPCA0200	7.1 (17.6)	8.7 (21.6)	11.6 (28.7)	13.7 (34.1)	7.8 (19.4)	11.2 (27.9)	17.1 (42.6)	21.5 (53.6)
TJPCA300	6.0 (14.9)	7.8 (19.5)	11.2 (27.7)	13.7 (34.1)	4.5 (11.2)	6.3 (15.7)	9.7 (24.2)	12.2 (30.4)
TJPCA0500	5.5 (13.7)	7.5 (18.5)	11.0 (27.3)	–	4.8 (12.0)	6.8 (16.9)	10.3 (25.6)	–
TJPCA0750	6.7 (16.6)	9.3 (23.0)	13.9 (34.6)	–	6.3 (15.7)	8.9 (22.2)	13.5 (33.6)	–
TJPCA1000	5.5 (13.7)	7.1 (17.7)	10.1 (25.1)	–	4.0 (10.0)	5.6 (13.9)	8.6 (21.4)	–
TJPCA1500	3.7 (9.2)	5.5 (13.6)	8.8 (21.7)	11.2 (27.8)	4.4 (10.9)	6.2 (15.4)	9.5 (23.5)	11.9 (29.5)
TJPCA2000	3.6 (8.9)	6.6 (16.3)	12.0 (29.7)	16.0 (39.8)	7.3 (18.2)	10.3 (25.6)	15.7 (39.1)	19.7 (49.1)

### Inlet pressure TJPCA, Propane

Type	Main Gas, "w.c. (mbar), measured at Tap B				Air, "w.c. (mbar), measured at Tap A			
	Combustion Air Temperature							
	Ambient	300°F (150°C)	700°F (370°C)	1000°F (540°C)	Ambient	300°F (150°C)	700°F (370°C)	1000°F (540°C)
TJPCA0015	7.5 (18.6)	9.8 (24.4)	14.0 (34.9)	17.2 (42.7)	3.5 (8.7)	5 (12.5)	7.7 (19.2)	9.6 (23.9)
TJPCA0025	7.4 (18.4)	9.4 (23.4)	31.1 (32.6)	15.9 (39.5)	6.3 (15.7)	9.1 (22.7)	13.8 (34.4)	17.4 (43.3)
TJPCA0040	5.5 (13.7)	7.4 (18.4)	10.9 (27.1)	13.5 (33.5)	3.4 (8.5)	4.9 (12.2)	7.4 (18.4)	9.4 (23.4)
TJPCA0050	11.4 (28.3)	13.8 (34.2)	18.1 (44.8)	21.3 (52.8)	5.2 (13)	7.5 (18.7)	11.4 (28.4)	14.3 (35.6)
TJPCA0075	10.2 (25.3)	11.5 (28.6)	13.9 (34.4)	15.7 (38.9)	3.8 (9.5)	5.4 (13.5)	8.3 (20.7)	10.5 (26.2)
TJPCA0100	8.0 (19.9)	9.2 (22.9)	11.4 (28.4)	13.1 (32.6)	3.5 (8.7)	5 (12.5)	7.7 (19.2)	9.6 (23.9)
TJPCA0150	6.0 (14.9)	7.5 (18.7)	10.4 (25.7)	12.5 (31.0)	4.5 (11.2)	6.5 (16.2)	9.8 (24.4)	12.4 (30.9)
TJPCA0200	8.5 (21.1)	10.5 (26.1)	14.1 (35.1)	16.8 (41.8)	7.8 (19.4)	11.2 (27.9)	17.1 (42.6)	21.5 (53.6)
TJPCA0300	6.8 (16.9)	8.6 (21.4)	12.0 (29.7)	14.5 (35.9)	4.5 (11.2)	6.3 (15.7)	9.7 (24.2)	12.2 (30.4)
TJPCA0500	6.0 (14.9)	8.0 (19.8)	11.5 (28.6)	–	4.8 (12.0)	6.8 (16.9)	10.3 (25.6)	–

## 5 Technical data

Type	Main Gas, "w.c. (mbar), measured at Tap B				Air, "w.c. (mbar), measured at Tap A			
	Combustion Air Temperature							
	Ambient	300°F (150°C)	700°F (370°C)	1000°F (540°C)	Ambient	300°F (150°C)	700°F (370°C)	1000°F (540°C)
TJPCA0750	6.7 (16.6)	9.3 (23.0)	13.9 (34.6)	–	6.3 (15.7)	8.9 (22.2)	13.5 (33.6)	–
TJPCA1000	5.5 (13.7)	7.1 (17.7)	10.1 (25.1)	–	4.0 (10.0)	5.6 (13.9)	8.6 (21.4)	–
TJPCA1500	3.7 (9.2)	5.5 (13.6)	8.8 (21.7)	11.2 (27.8)	4.4 (10.9)	6.2 (15.4)	9.5 (23.5)	11.9 (29.5)
TJPCA2000	3.6 (8.9)	6.6 (16.3)	12.0 (29.7)	16.0 (39.8)	7.3 (18.2)	10.3 (25.6)	15.7 (39.1)	19.7 (49.1)

### Inlet pressure TJPCA, Butane

Type	Main Gas, "w.c. (mbar), measured at Tap B				Air, "w.c. (mbar), measured at Tap A			
	Combustion Air Temperature							
	Ambient	300°F (150°C)	700°F (370°C)	1000°F (540°C)	Ambient	300°F (150°C)	700°F (370°C)	1000°F (540°C)
TJPCA0015	7.5 (18.6)	9.8 (24.4)	14.0 (34.9)	17.2 (42.7)	3.5 (8.7)	5 (12.5)	7.7 (19.2)	9.6 (23.9)
TJPCA0025	7.0 (17.4)	9.0 (22.4)	12.7 (31.6)	15.5 (38.5)	6.3 (15.7)	9.1 (22.7)	13.8 (34.4)	17.4 (43.3)
TJPCA0040	5.0 (12.4)	6.9 (17.2)	10.4 (25.8)	13.0 (32.3)	3.4 (8.5)	4.9 (12.2)	7.4 (18.4)	9.4 (23.4)
TJPCA0050	9.6 (23.8)	11.8 (29.3)	15.8 (39.2)	18.8 (46.7)	5.2 (13)	7.5 (18.7)	11.4 (28.4)	14.3 (35.6)
TJPCA0075	9.7 (24.1)	11.1 (27.5)	13.6 (33.8)	15.8 (38.5)	3.8 (9.5)	5.4 (13.5)	8.3 (20.7)	10.5 (26.2)
TJPCA0100	7.5 (18.6)	8.7 (21.7)	10.9 (27.2)	12.6 (31.3)	3.5 (8.7)	5 (12.5)	7.7 (19.2)	9.6 (23.9)
TJPCA0150	6.5 (16.1)	8.3 (20.5)	11.4 (28.4)	13.8 (34.3)	4.5 (11.2)	6.5 (16.2)	9.8 (24.4)	12.4 (30.9)
TJPCA0200	6.9 (17.1)	8.9 (22.1)	12.5 (31.1)	15.2 (37.9)	7.8 (19.4)	11.2 (27.9)	17.1 (42.6)	21.5 (53.6)
TJPCA0300	6.0 (14.9)	7.8 (19.5)	11.2 (27.7)	13.7 (34.1)	4.5 (11.2)	6.3 (15.7)	9.7 (24.2)	12.2 (30.4)
TJPCA0500	5.5 (13.7)	7.5 (18.5)	11.0 (27.3)	–	4.8 (12.0)	6.8 (16.9)	10.3 (25.6)	–
TJPCA0750	6.7 (16.6)	9.3 (23.0)	13.9 (34.6)	–	6.3 (15.7)	8.9 (22.2)	13.5 (33.6)	–
TJPCA1000	5.5 (13.7)	7.1 (17.7)	10.1 (25.1)	–	4.0 (10.0)	5.6 (13.9)	8.6 (21.4)	–
TJPCA1500	3.7 (9.2)	5.5 (13.6)	8.8 (21.7)	11.2 (27.8)	4.4 (10.9)	6.2 (15.4)	9.5 (23.5)	11.9 (29.5)
TJPCA2000	3.6 (8.9)	6.6 (16.3)	12.0 (29.7)	16.0 (39.8)	7.3 (18.2)	10.3 (25.6)	15.7 (39.1)	19.7 (49.1)

## 5.4 Flame length and Velocity TJ

Type	High Fire Visible Flame Length, inches (mm) <sup>1</sup>						Approximate Flame Velocity, ft/s (m/s) <sup>2</sup>	
	High Velocity			Medium Velocity			High Velocity	Medium Velocity
	Natural Gas	Propane	Butane	Natural Gas	Propane	Butane		
TJ0015	9.0 (229)	9.0 (229)	9.0 (229)	11.0 (279)	10.0 (254)	11.0 (279)	440 (134)	270 (82)
TJ0025	12.0 (305)	12.0 (305)	13.0 (330)	14.0 (356)	14.0 (356)	14.0 (356)	440 (134)	260 (79)
TJ0040	14.0 (356)	17.0 (432)	17.0 (432)	18.0 (457)	19.0 (483)	19.0 (483)	540 (165)	320 (98)
TJ0050	25 (635)	33 (838)	30 (762)	28 (711)	36 (914)	39 (991)	540 (165)	320 (98)
TJ0075	28 (711)	30 (762)	33 (838)	28 (711)	38 (965)	38 (965)	480 (146)	250 (76)
TJ0100	33 (835)	34 (865)	35 (890)	38 (965)	37 (940)	42 (1065)	630 (192)	310 (95)
TJ0150	38 (965)	42 (1065)	43 (1090)	43 (1090)	42 (1065)	44 (1120)	680 (207)	350 (107)
TJ0200	34 (864)	36 (914)	36 (914)	38 (965)	38 (965)	38 (965)	500 (152)	330 (101)
TJ0300	50 (1270)	55 (1400)	55 (1400)	64 (1630)	66 (1675)	68 (1730)	550 (168)	300 (91)
TJ0500	75 (1900)	90 (2285)	85 (2160)	100 (2550)	100 (2550)	105 (2670)	580 (177)	280 (85)
TJ0750	100 (2540)	115 (2921)	110 (2794)	125 (3175)	125 (3175)	130 (3302)	570 (174)	280 (85)
TJ1000	124 (3150)	139 (3531)	134 (3404)	149 (3785)	149 (3785)	154 (3912)	380 (116)	280 (85)
TJ1500	84 (2134)	108 (2743)	108 (2743)	144 (3660)	185 (4700)	185 (4700)	560 (171)	180 (55)
TJ2000	84 (2134)	108 (2743)	108 (2743)	168 (4267)	216 (5486)	216 (5486)	540 (165)	250 (76)

<sup>1</sup> Measured from the outlet end of the combustor

<sup>2</sup> Approximately 15% excess air at maximum input

- All information is based on laboratory testing in neutral (0 "w.c., 0 mbar) pressure chamber. Different chamber conditions may affect the data.
- All information is based on standard combustor design. Changes in combustor will alter performance and pressures.
- All inputs based upon standard conditions; 1 atmosphere, 70°F (21°C).
- Honeywell Eclipse reserves the right to change the construction and/or configuration of our products at any time without being obliged to adjust earlier supplies accordingly.

- Plumbing of air and gas will affect accuracy of orifice readings. All information is based on generally acceptable air and gas piping practices.



## 5.5 Max. High Fire Visible Flame Length

### TJPCA

Type	inches (mm) <sup>1</sup>		
	Natural Gas	Propane	Butane
TJPCA0015	11.0 (279)	10.0 (254)	11.0 (279)
TJPCA0025	14.0 (356)	14.0 (356)	14.0 (356)
TJPCA0040	18.0 (457)	19.0 (483)	19.0 (483)
TJPCA0050	28 (711)	36 (914)	39 (991)
TJPCA0075	28 (711)	38 (965)	38 (965)
TJPCA0100	38 (965)	37 (940)	42 (1065)
TJPCA0150	43 (1090)	42 (1065)	44 (1120)
TJPCA0200	36 (915)	32 (810)	32 (810)
TJPCA0300	64 (1630)	66 (1675)	68 (1730)
TJPCA0500	100 (2550)	100 (2550)	105 (2670)
TJPCA0750	125 (3175)	125 (3175)	130 (3302)
TJPCA1000	149 (3785)	149 (3785)	154 (3912)
TJPCA1500	144 (3660)	185 (4700)	185 (4700)
TJPCA2000	168 (4267)	216 (5486)	216 (5486)

<sup>1</sup> Measured from the outlet end of the combustor

## 5.6 Performance Graphs

Emissions correction factor for medium velocity combustor is 1.20. Emissions data based on, on-ratio control firing at 15% excess air corrected to 3% O<sub>2</sub>. Emissions from the burner are influenced by:

- Fuel type
- Combustion air temperature
- Firing rate
- Chamber conditions
- Percent of excess air

5.6.1 TJ0015, TJPCA0015

Ignition and Operation Zone for ambient temperature – TJ/TJPCA

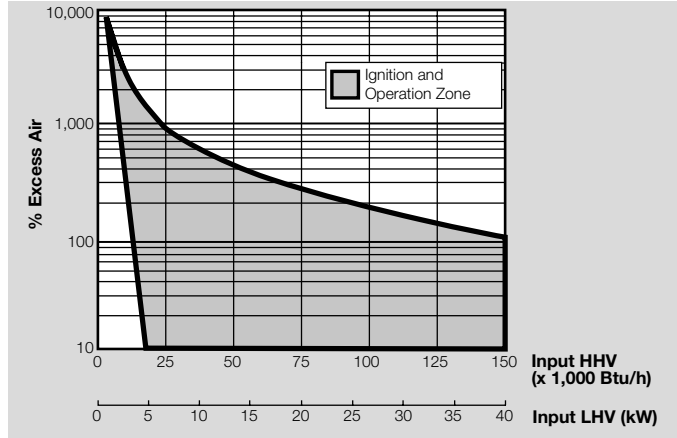

Fuel Orifice  $\Delta p$  vs. Input – TJ/TJPCA

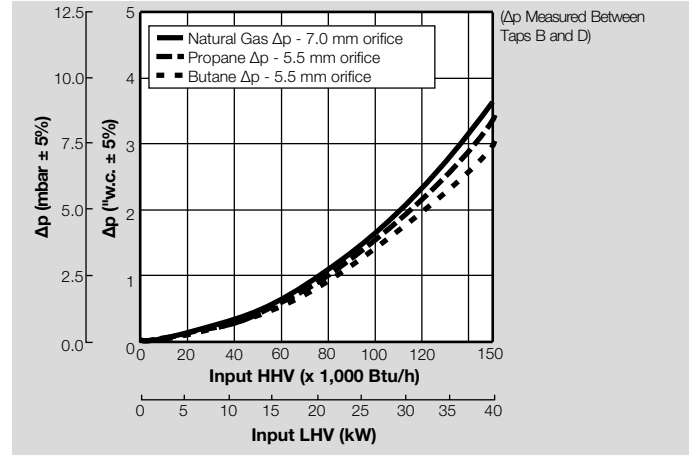

NO<sub>x</sub> Emission – TJ

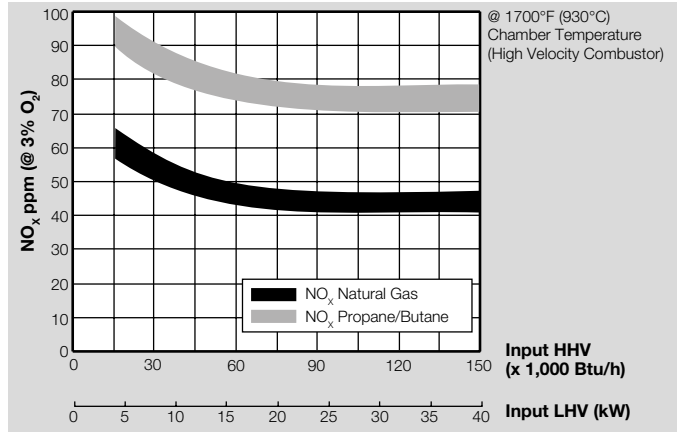

Air Orifice  $\Delta p$  vs. Input - TJ

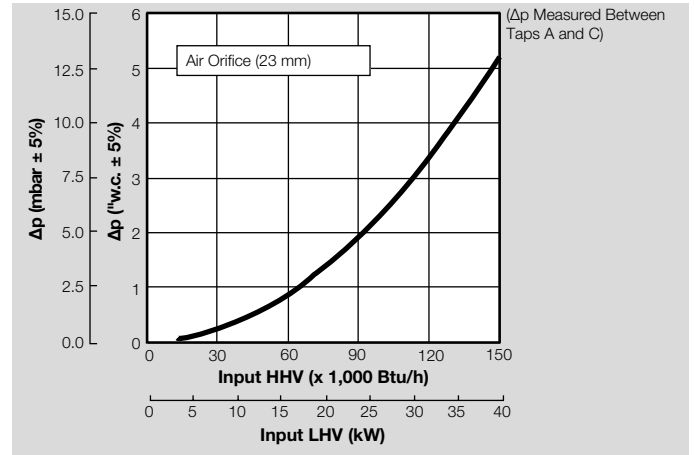

5.6.2 TJ0025. TJPCA0025

Ignition and Operation Zone for ambient temperature – TJ/TJPCA

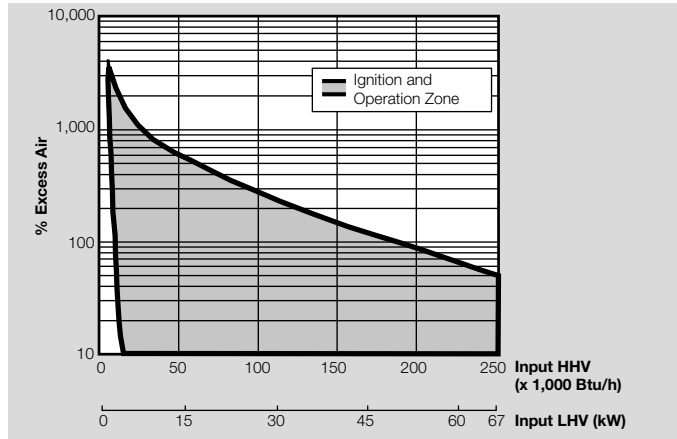

Fuel Orifice  $\Delta p$  vs. Input – TJ/TJPCA

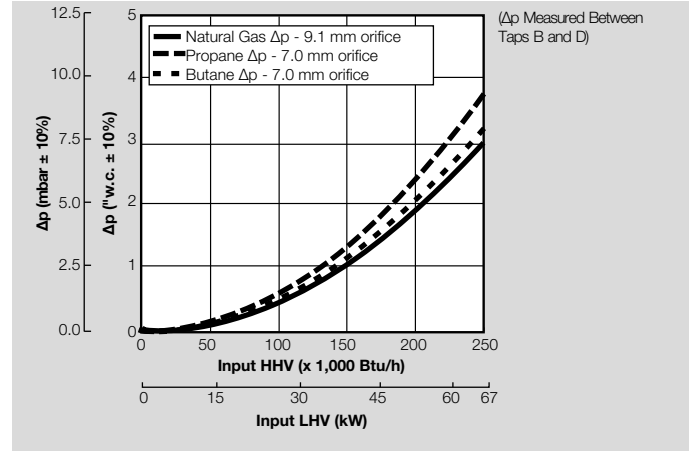

NO<sub>x</sub> Emission – TJ

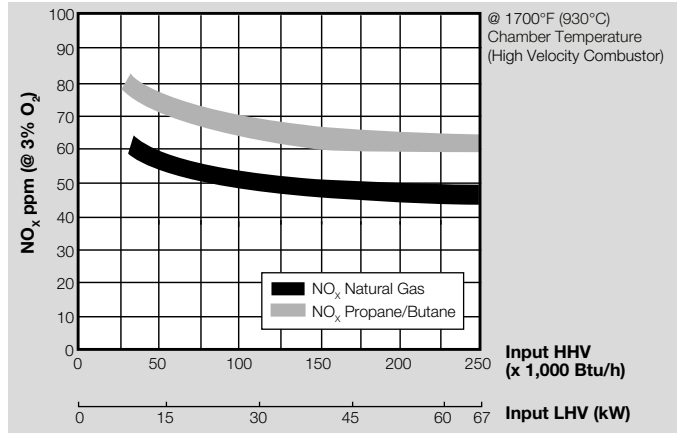

Air Orifice  $\Delta p$  vs. Input – TJ

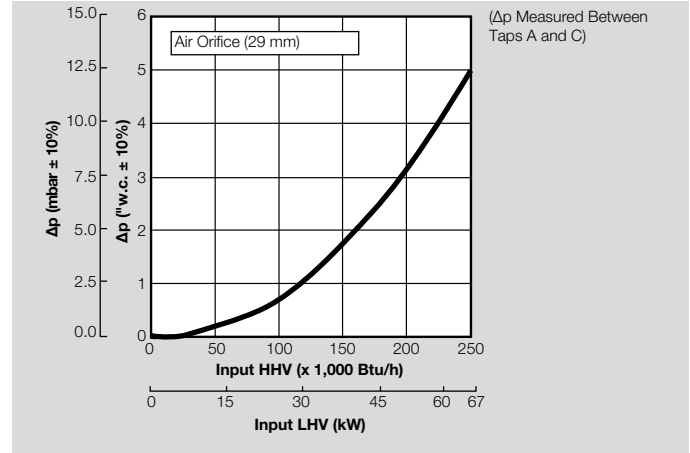

### 5.6.3 TJ0040, TJPCA0040

#### Ignition and Operation Zone for ambient temperature – TJ/TJPCA

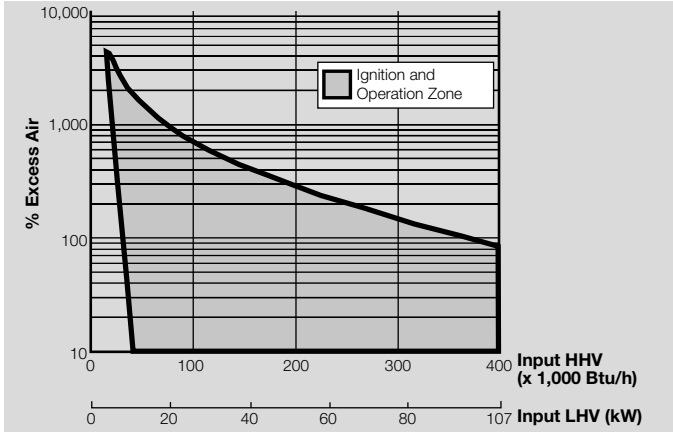

#### NO<sub>x</sub> Emission – TJ

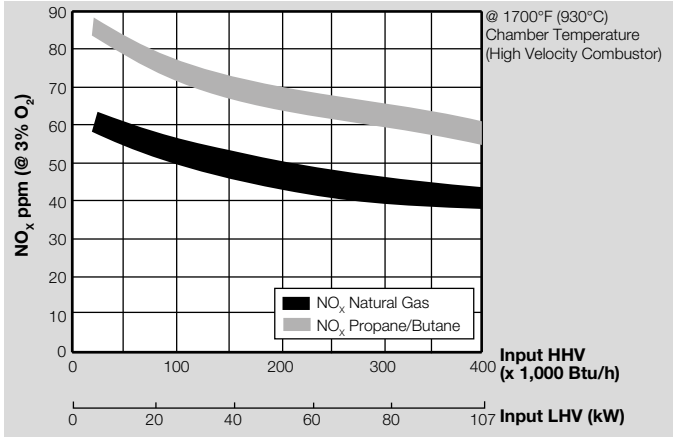

#### Fuel Orifice Δp vs. Input – TJ/TJPCA

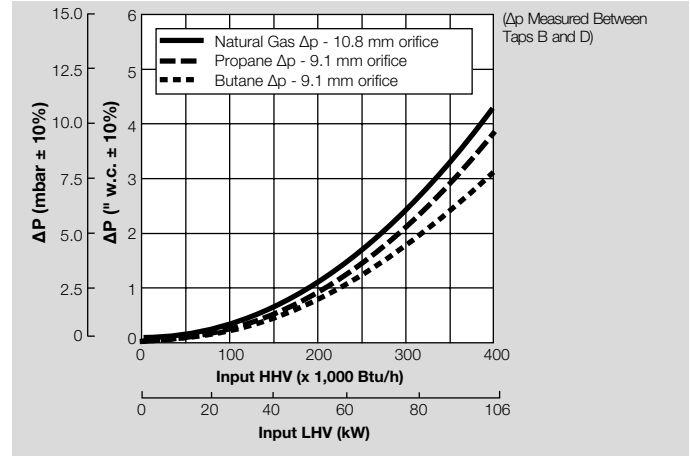

#### Air Orifice Δp vs. Input – TJ

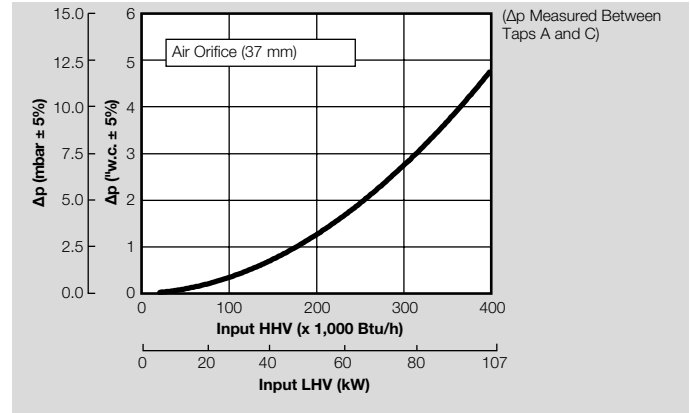

5.6.4 TJ0050, TJPCA0050

Ignition and Operation Zone for ambient temperature – TJ/TJPCA

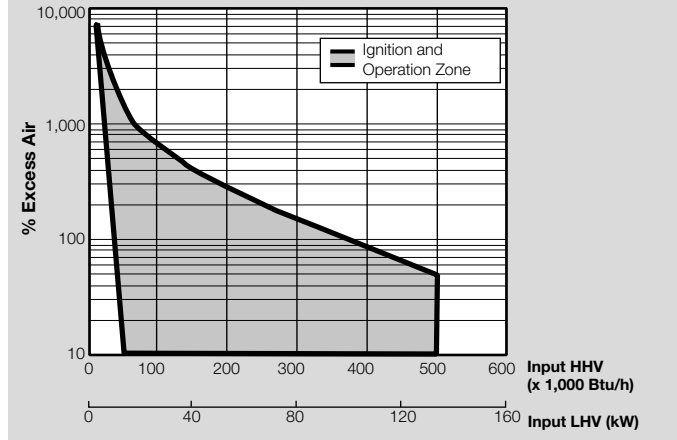

NO<sub>x</sub> Emission – TJ

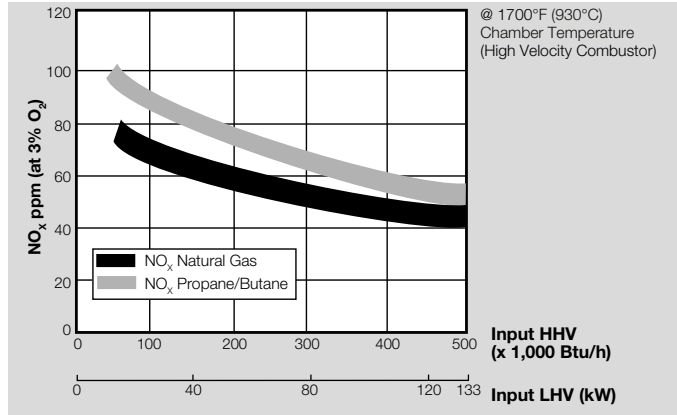

Fuel Orifice Δp vs. Input – TJ/TJPCA

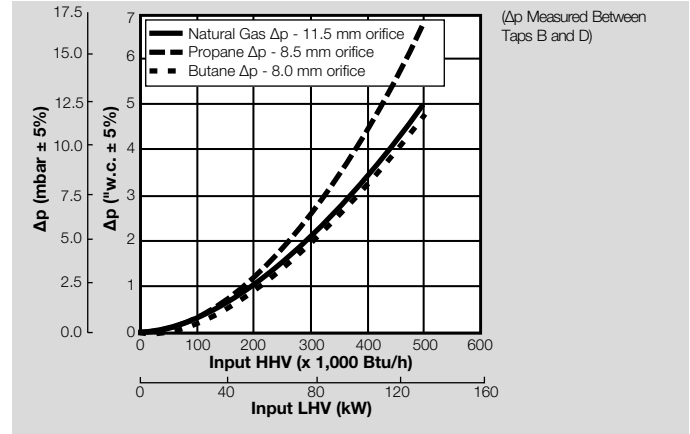

Air Orifice Δp vs. Input – TJ

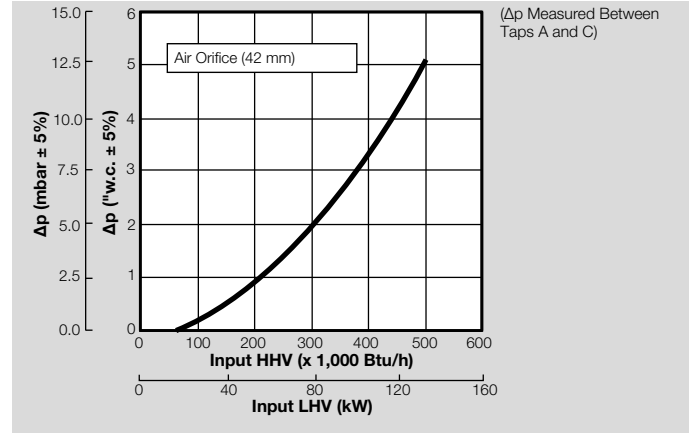

5.6.5 TJ0075, TJPCA0075

Ignition and Operation Zone for ambient temperature – TJ/TJPCA

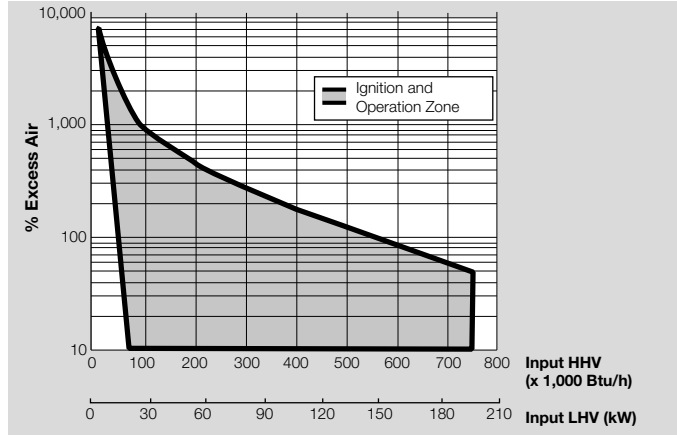

NO<sub>x</sub> Emission – TJ

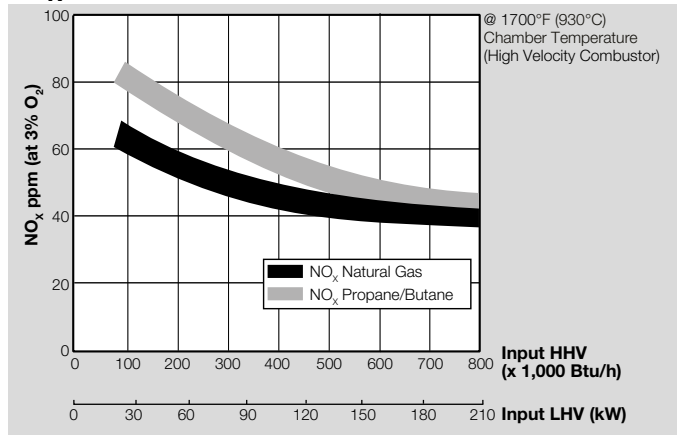

Fuel Orifice Δp vs. Input – TJ/TJPCA

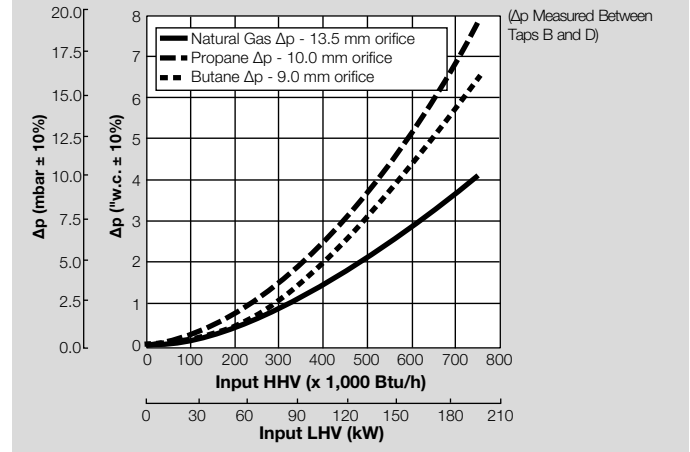

Air Orifice Δp vs. Input – TJ

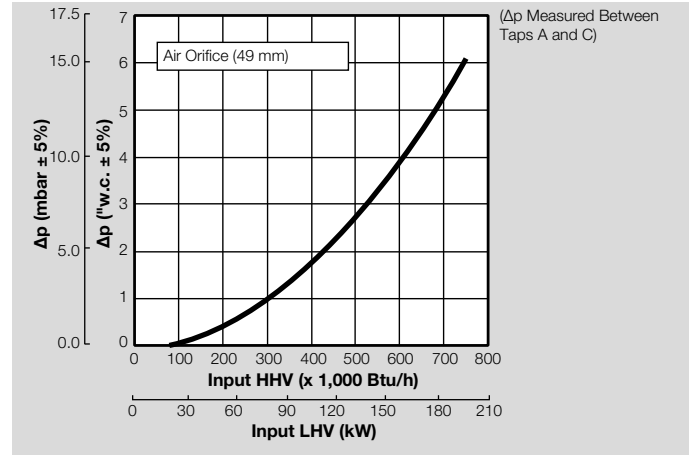

### 5.6.6 TJ0100, TJPCA0100

#### Ignition and Operation Zone for ambient temperature – TJ/TJPCA

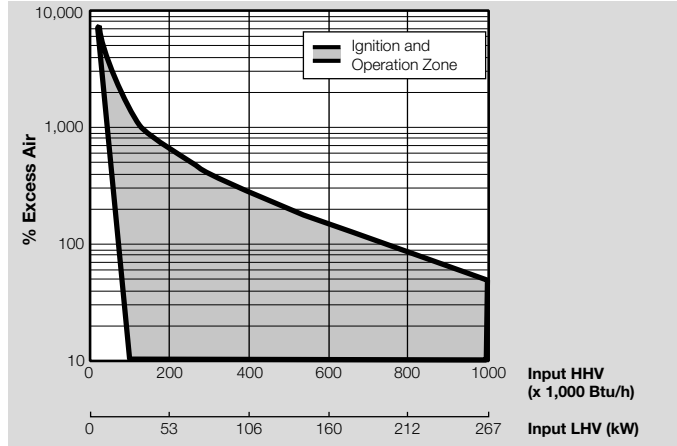

#### NO<sub>x</sub> Emission – TJ

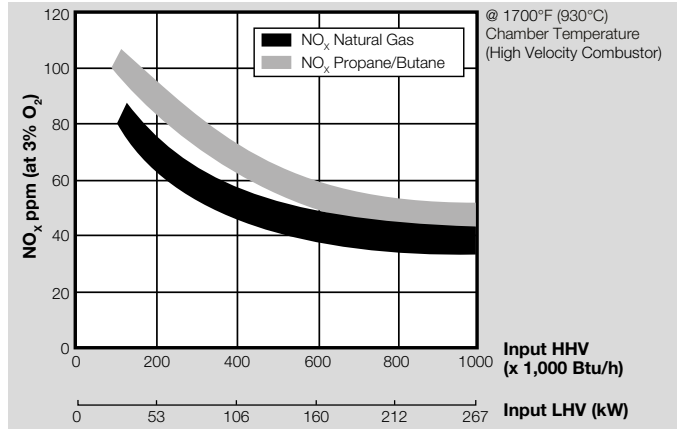

#### Fuel Orifice Δp vs. Input – TJ/TJPCA

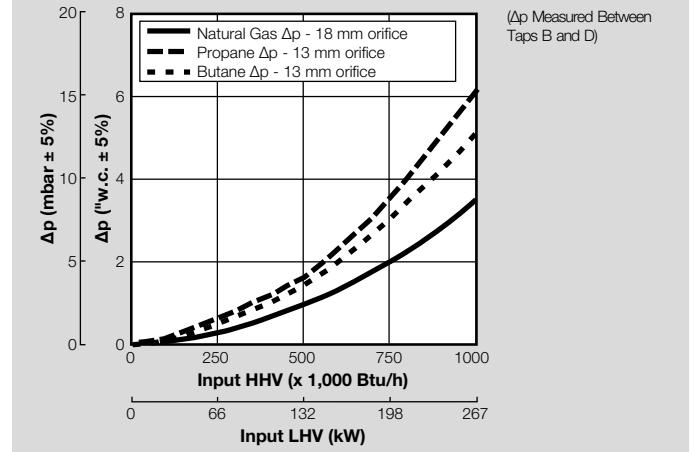

#### Air Orifice Δp vs. Input – TJ/TJPCA

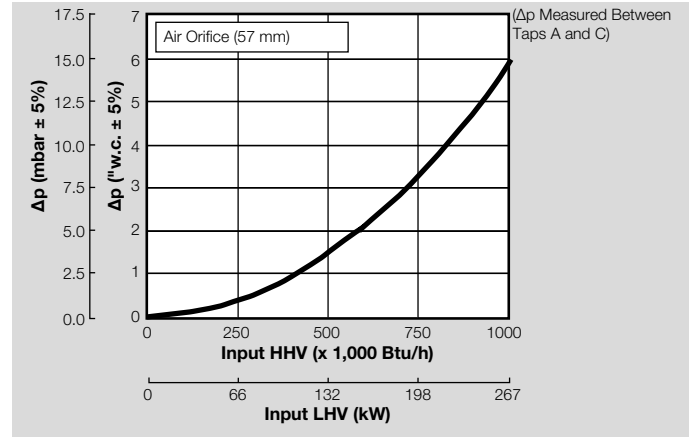

5.6.7 TJ0150, TJPCA0150

Ignition and Operation Zone for ambient temperature – TJ/TJPCA

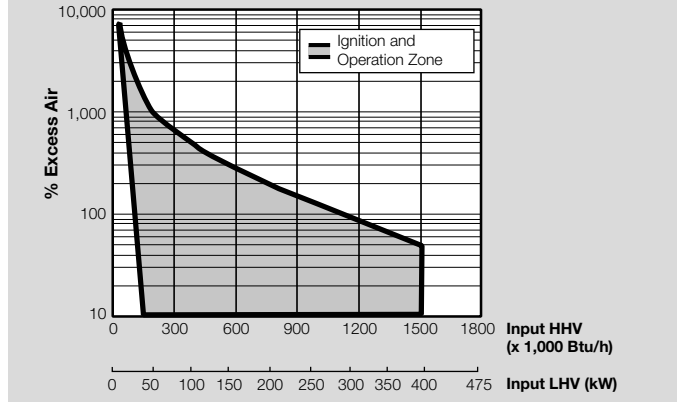

Fuel Orifice Δp vs. Input – TJ/TJPCA

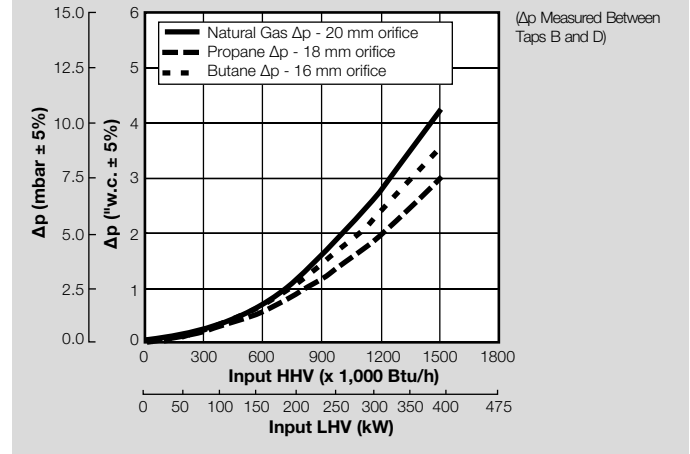

NO<sub>x</sub> Emission – TJ

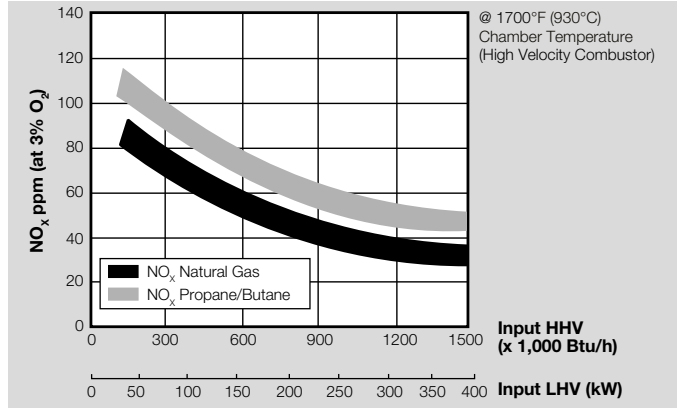

Air Orifice Δp vs. Input – TJ

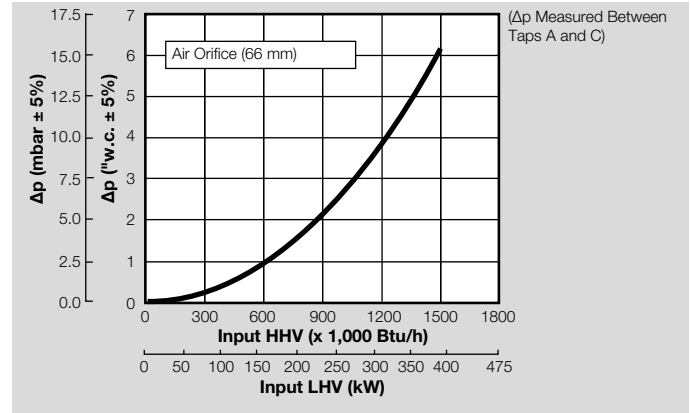



5.6.8 TJ0200, TJPCA0200

Ignition and Operation Zone for ambient temperature – TJ/TJPCA

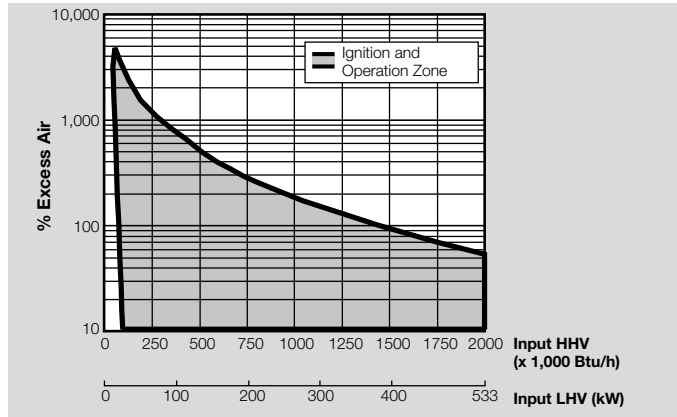

Fuel Orifice  $\Delta p$  vs. Input – TJ/TJPCA

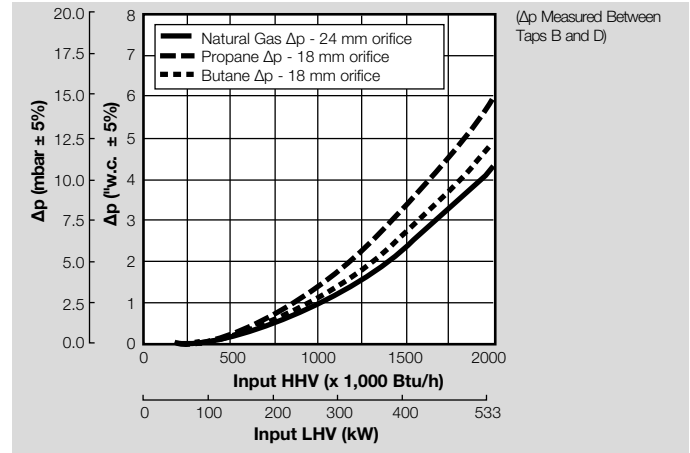

$\text{NO}_x$  Emission – TJ

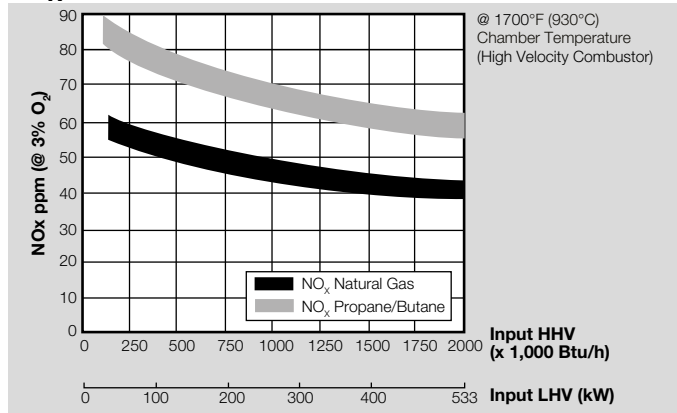

Air Orifice  $\Delta p$  vs. Input – TJ/TJPCA

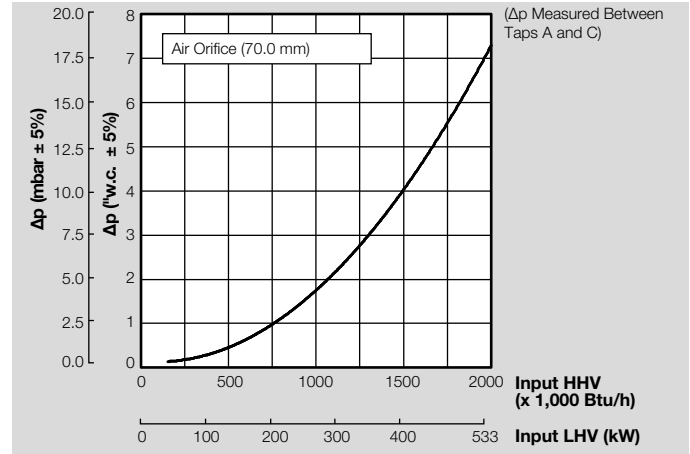

5.6.9 TJ0300, TJPCA0300

Ignition and Operation Zone for ambient temperature – TJ/TJPCA

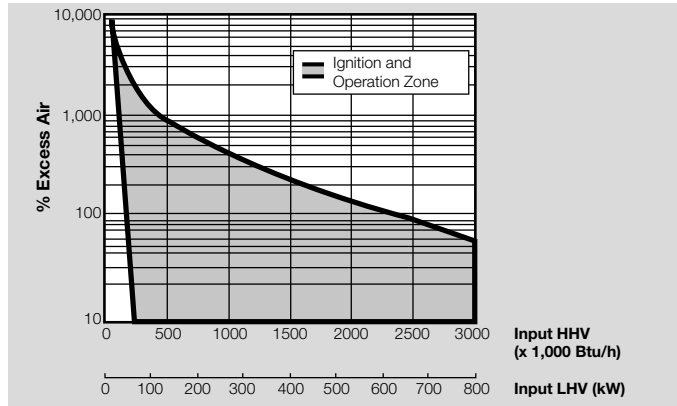

Fuel Orifice Δp vs. Input – TJ/TJPCA

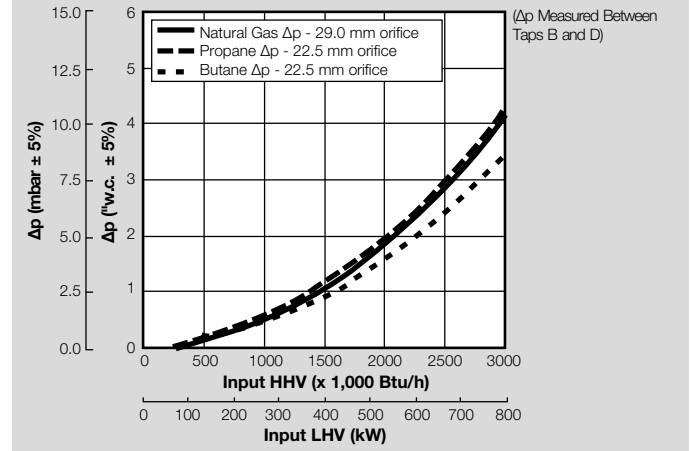

NO<sub>x</sub> Emission – TJ

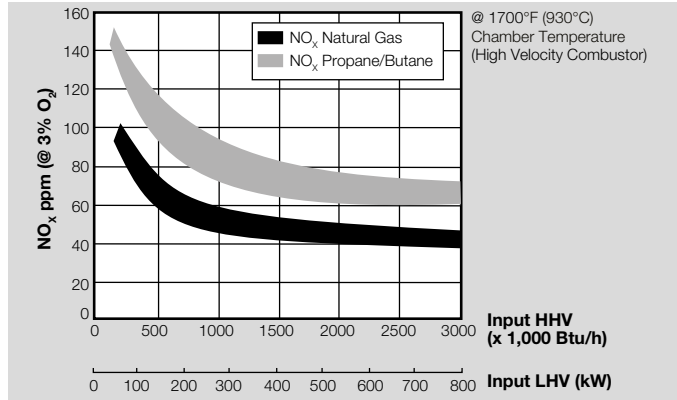

Air Orifice Δp vs. Input – TJ

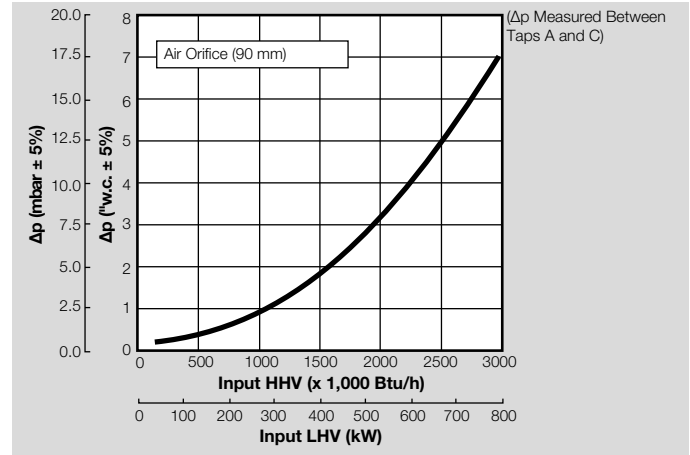

5.6.10 TJ0500, TJPCA0500

Ignition and Operation Zone for ambient temperature – TJ/TJPCA

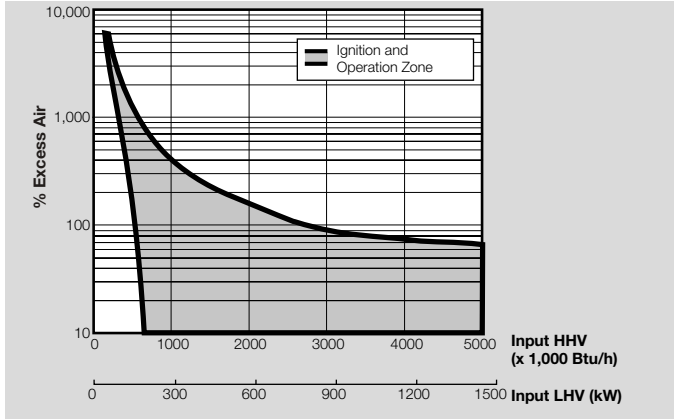

NO<sub>x</sub> Emission – TJ

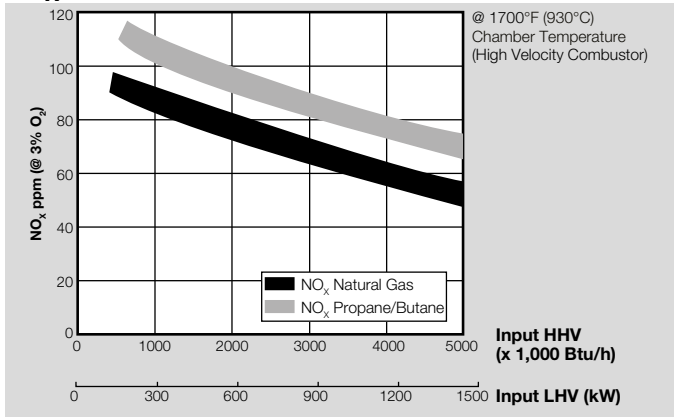

Fuel Orifice Δp vs. Input – TJ/TJPCA

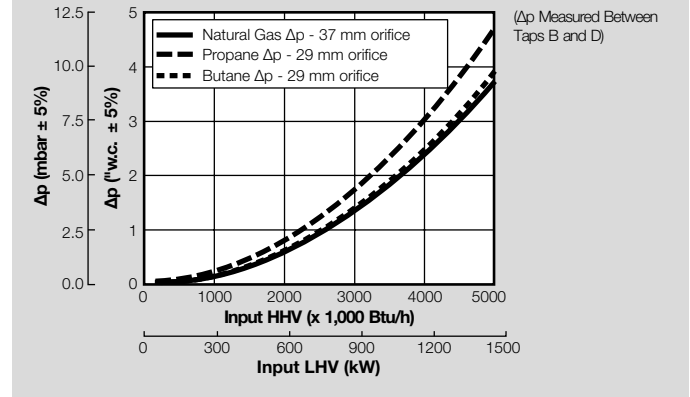

Air Orifice Δp vs. Input – TJ

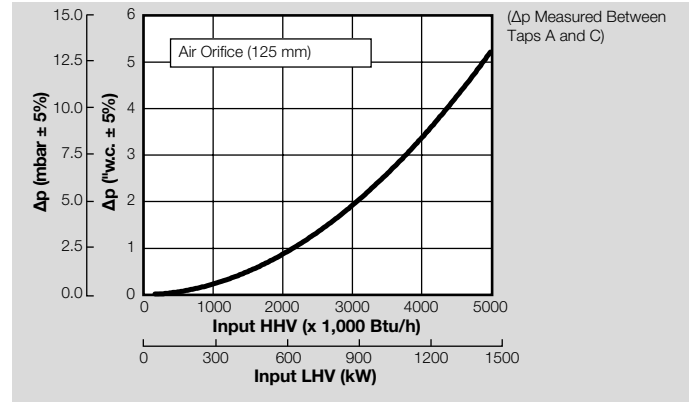

5.6.11 TJ0750, TJPCA0750

Ignition and Operation Zone for ambient temperature – TJ/TJPCA

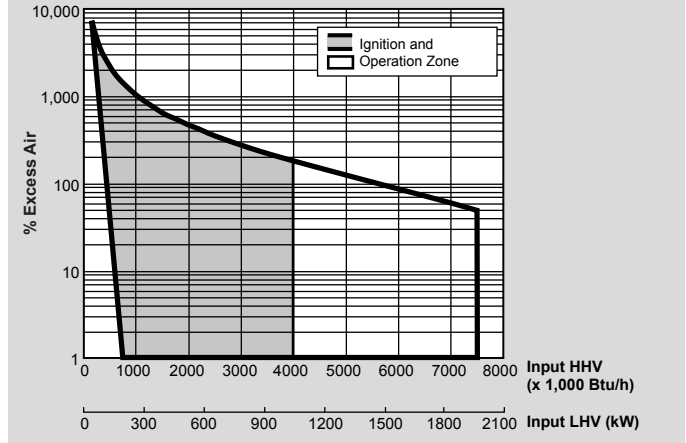

NO<sub>x</sub> Emission – TJ

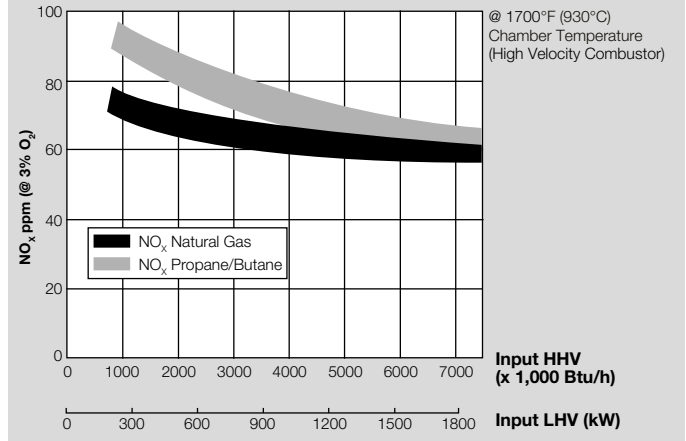

Fuel Orifice Δp vs. Input – TJ/TJPCA

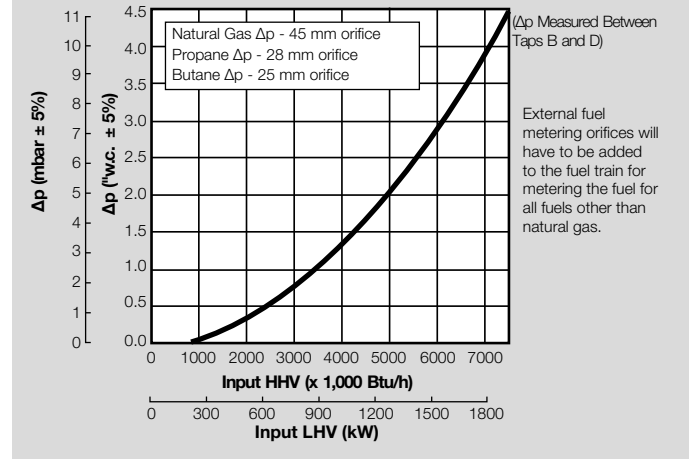

Air Orifice Δp vs. Input – TJ

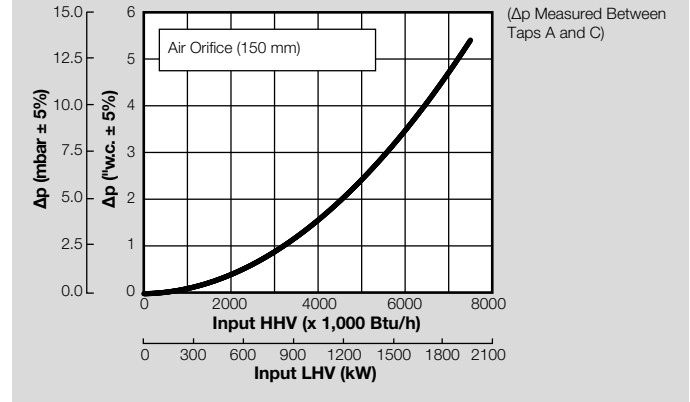

5.6.12 TJ1000, TJPCA1000

Ignition and Operation Zone for ambient temperature – TJ/TJPCA

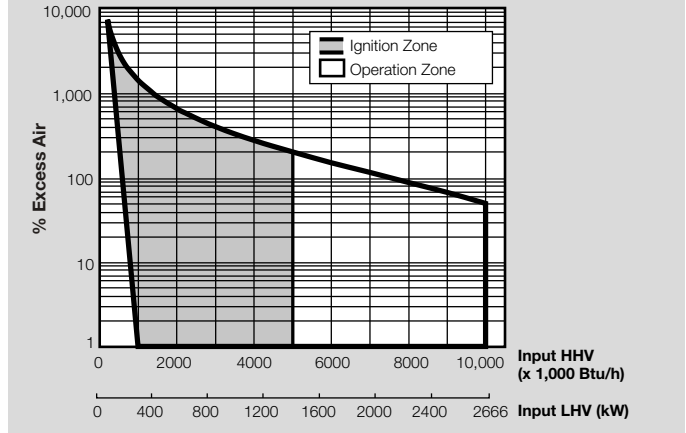

Fuel Orifice Δp vs. Input – TJ/TJPCA

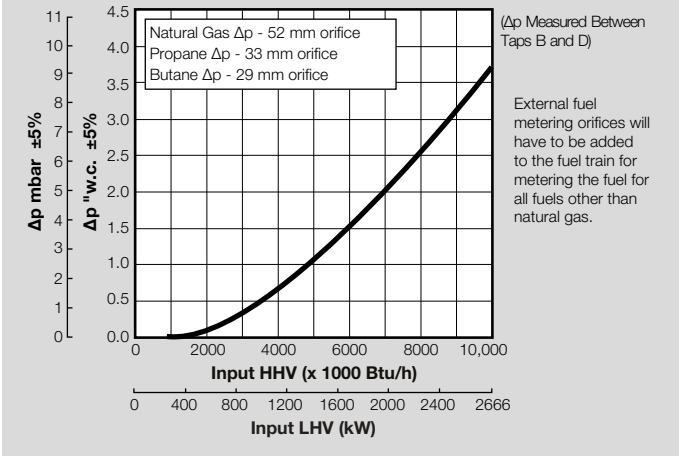

NO<sub>x</sub> Emission – TJ

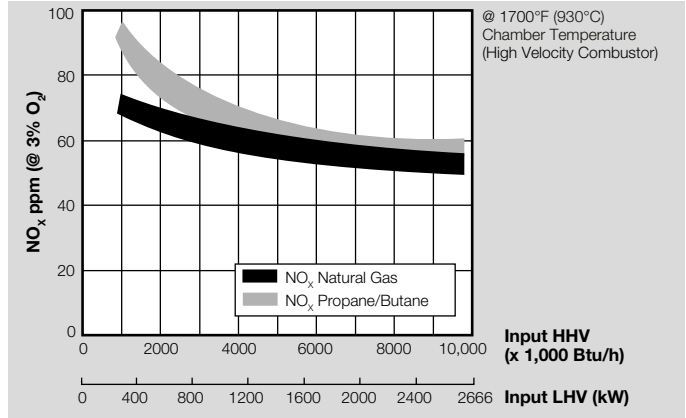

Air Orifice Δp vs. Input – TJ

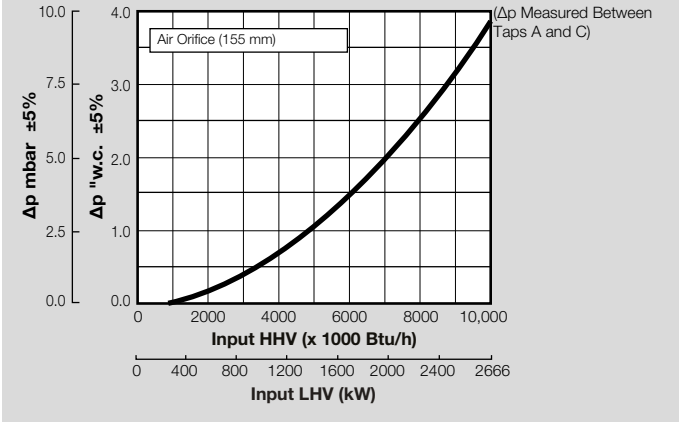

5.6.13 TJ1500, TJPCA1500

Ignition and Operation Zone for ambient temperature – TJ/TJPCA

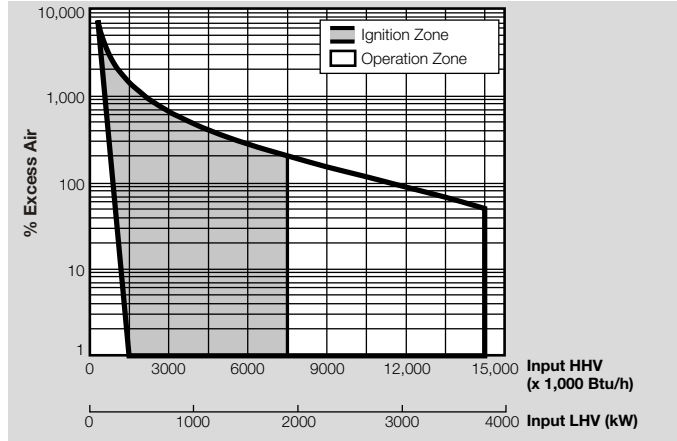

Fuel Orifice  $\Delta p$  vs. Input – TJ/TJPCA

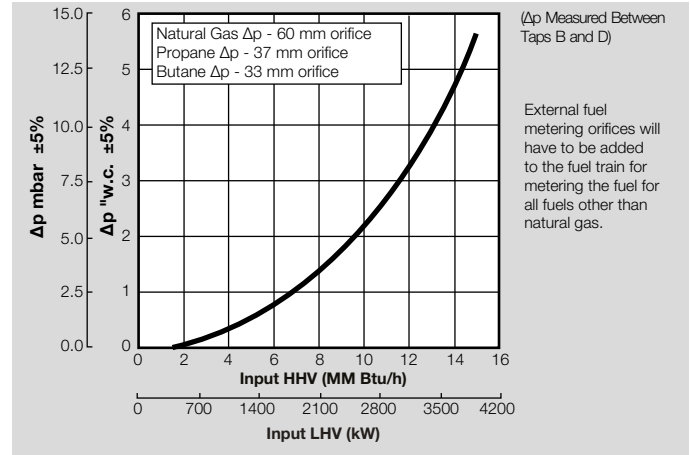

NO<sub>x</sub> Emission – TJ

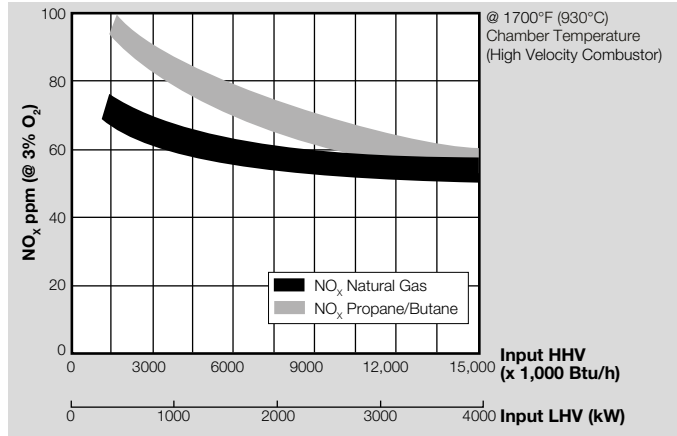

Air Orifice  $\Delta p$  vs. Input – TJ

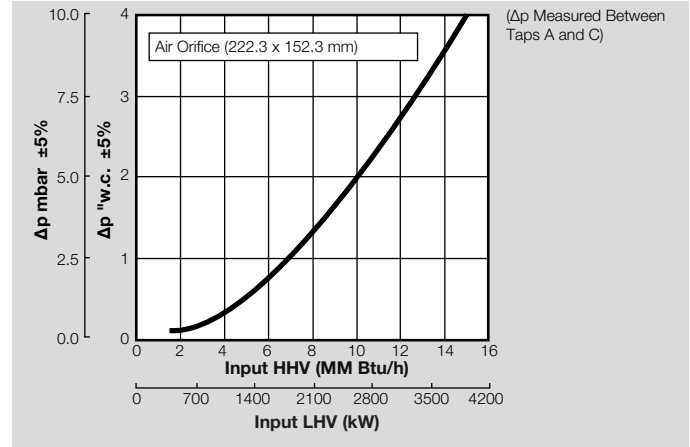

5.6.14 TJ2000, TJPCA2000

Ignition and Operation Zone for ambient temperature – TJ/TJPCA

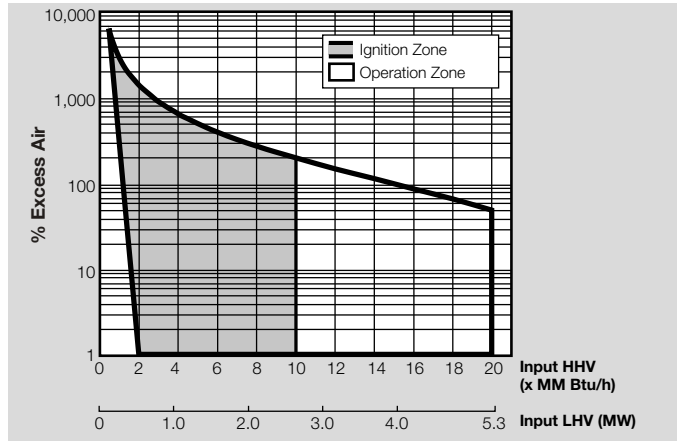

Fuel Orifice  $\Delta p$  vs. Input – TJ/TJPCA

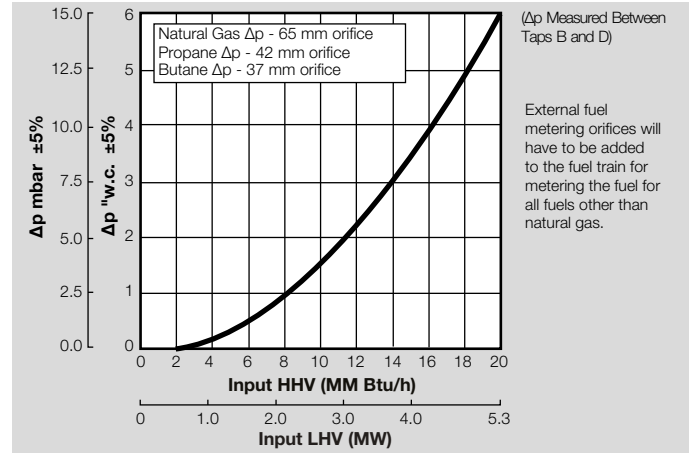

NO<sub>x</sub> Emission – TJ

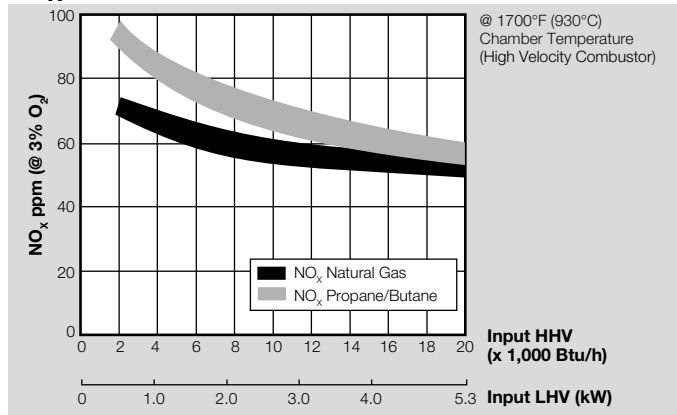

Air Orifice  $\Delta p$  vs. Input – TJ

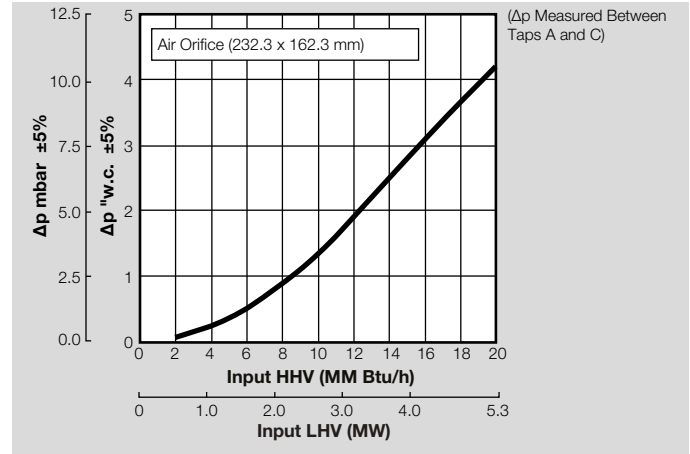

## 5.7 Dimensions

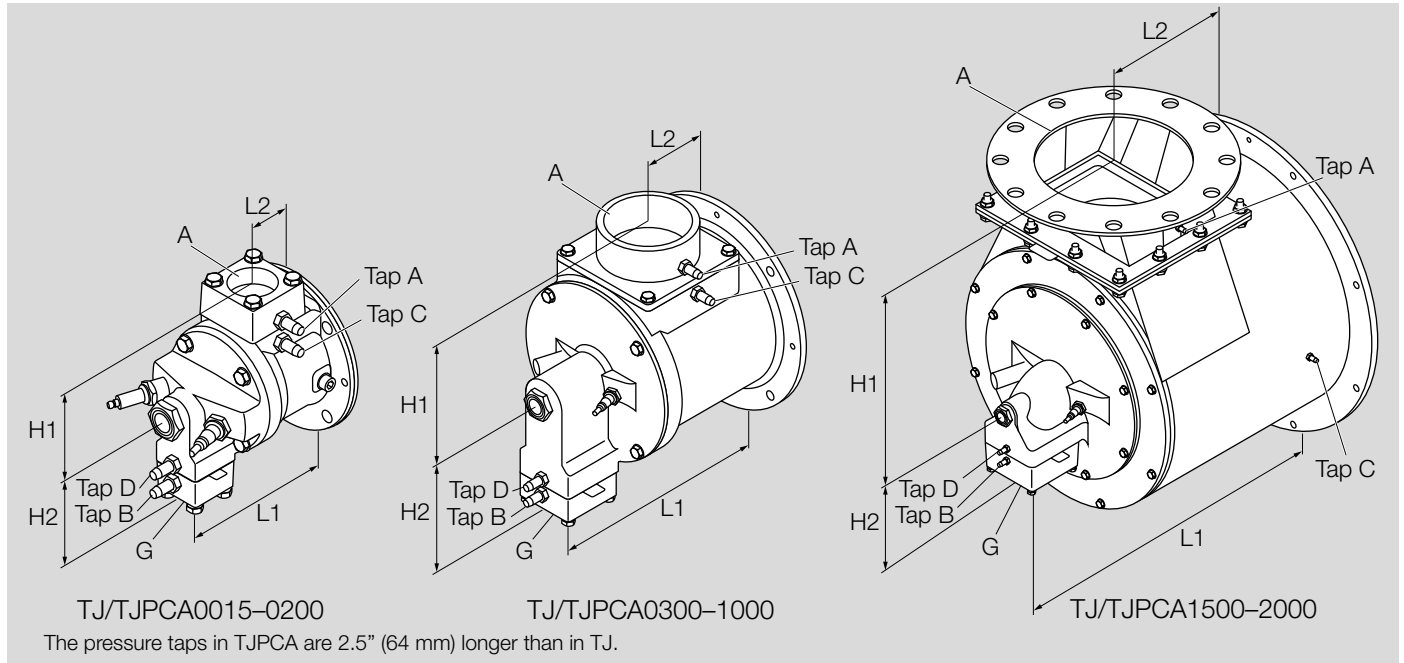

### inch

Type	Gas inlet G	Air inlet A	L1	L2	H1	H2	Weight [lbs]
TJ/TJPCA0015	1/2" NPT/Rc 0.5	1 1/2" NPT/Rc 1.5	4.9	2.1	3.8	3.5	17.9
TJ/TJPCA0025	1/2" NPT/Rc 0.5	1 1/2" NPT/Rc 1.5	4.9	2.1	3.8	3.5	17.9
TJ/TJPCA0040	3/4" NPT/Rc 0.75	2" NPT/Rc 2.0	6.6	3.3	3.8	3.5	21.6
TJ/TJPCA0050	1" NPT/Rc 1.0	2 1/2" NPT/Rc 2.5	7.1	3.4	5.1	3.1	37
TJ/TJPCA0075	1" NPT/Rc 1.0	2 1/2" NPT/Rc 2.5	7.1	3.4	5.1	3.1	37
TJ/TJPCA0100	1 1/2" NPT/Rc 1.5	3" NPT/Rc 3.0	7.8	3.6	5.5	3.2	42
TJ/TJPCA0150	1 1/2" NPT/Rc 1.5	3" NPT/Rc 3.0	7.8	3.6	5.5	3.2	42
TJ/TJPCA0200	1 1/2" NPT/Rc 1.5	3" NPT/Rc 3.0	7.8	3.6	5.5	3.2	42
TJ/TJPCA0300	2" NPT/Rc 2.0	4" NPT/Rc 4.0	10.8	5.1	7.2	6.4	89



## 5 Technical data

Type	Gas inlet G	Air inlet A	L1	L2	H1	H2	Weight [lbs]
TJ/TJPCA0500	2" NPT/Rc 2.0	6" Welded	13.2	6.3	10.4	6.4	93
TJ/TJPCA0750	3" NPT/Rc 3.0	8" Welded	16.7	8.7	11.2	5.1	133
TJ/TJPCA1000	3" NPT/Rc 3.0	8" Welded	16.7	8.7	11.2	5.1	133
TJ/TJPCA1500	3" NPT/Rc 3.0	10" ANSI	19.7	12.4	14.8	5.1	208
TJ/TJPCA2000	3" NPT/Rc 3.0	10" ANSI	19.7	12.4	14.8	5.1	208

### mm

Type	Gas inlet G	Air inlet A	L1	L2	H1	H2	Weight [kg]
TJ/TJPCA0015	1/2" NPT/Rc 0.5	1 1/2" NPT/Rc 1.5	125.6	53	96.5	90	8.1
TJ/TJPCA0025	1/2" NPT/Rc 0.5	1 1/2" NPT/Rc 1.5	125.6	53	96.5	90	8.1
TJ/TJPCA0040	3/4" NPT/Rc 0.75	2" NPT/Rc 2.0	167	85	97.5	90	9.8
TJ/TJPCA0050	1" NPT/Rc 1.0	2 1/2" NPT/Rc 2.5	180	86.5	130.5	78.5	17
TJ/TJPCA0075	1" NPT/Rc 1.0	2 1/2" NPT/Rc 2.5	180	86.5	130.5	78.5	17
TJ/TJPCA0100	1 1/2" NPT/Rc 1.5	3" NPT/Rc 3.0	197.5	92.5	139	81.5	19
TJ/TJPCA0150	1 1/2" NPT/Rc 1.5	3" NPT/Rc 3.0	197.5	92.5	139	81.5	19
TJ/TJPCA0200	1 1/2" NPT/Rc 1.5	3" NPT/Rc 3.0	197.5	92.5	139	81.5	19
TJ/TJPCA0300	2" NPT/Rc 2.0	4" NPT/Rc 4.0	274	129	183.4	161.5	40
TJ/TJPCA0500	2" NPT/Rc 2.0	6" Welded	334	160.5	263.2	161.5	42
TJ/TJPCA0750	3" NPT/Rc 3.0	8" Welded	424	220.5	285.3	129.5	60
TJ/TJPCA1000	3" NPT/Rc 3.0	8" Welded	424	220.5	285.3	129.5	60
TJ/TJPCA1500	3" NPT/Rc 3.0	10" ANSI	500	315	376.5	129.5	95
TJ/TJPCA2000	3" NPT/Rc 3.0	10" ANSI	500	315	376.5	129.5	95

## 5.8 Combustors Dimensions and Specifications

### 5.8.1 TJ/TJPCA0015–0025

#### Alloy Combustor (AISI 310)

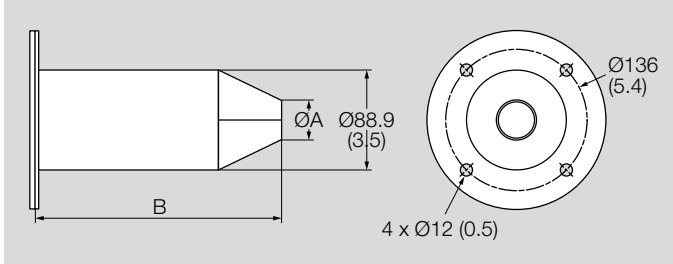

Weight: 2.1 lbs (0.95 kg)

Max. chamber temp: 1750°F (950°C) [Not suitable for pre-heated air over 700°F (371°C)]

#### Silicon Carbide Combustor

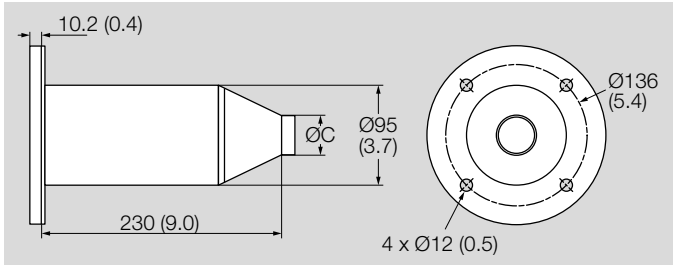

Weight: 3.6 lbs (1.6 kg)

Max. chamber temp: TJ: 2500°F (1371°C), TJPCA: 2200°F (1200°C)

Type	Velocity	ØA mm (inch)	B mm (inch)	ØC mm (inch)
TJ0015	High	Ø28.4 (1.1)	230.8 (9.1)	Ø35 (1.4)
TJ/TJPCA0015	Medium	Ø35.4 (1.4)	223.3 (8.8)	Ø42 (1.7)
TJ0025	High	Ø35.4 (1.4)	223.3 (8.8)	Ø42 (1.7)
TJ/TJPCA0025	Medium	Ø45.4 (1.8)	212.6 (8.4)	Ø52 (2.0)

#### Refractory Combustor with AISI 330 wrapper

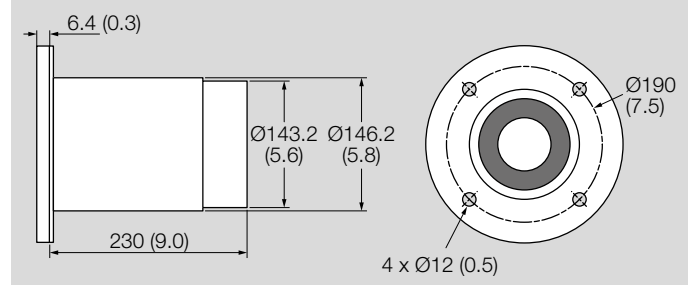

Dimensions in mm (inches)

Weight: 14 lbs (6.4 kg)

Max. chamber temp: 2800°F (1538°C)

**NOTE:** Mounting gasket shown on right side of combustor flange. Dimensions shown do not account for mounting gasket.

### 5.8.2 TJ/TJPCA0040

#### Alloy Combustor (AISI 310)

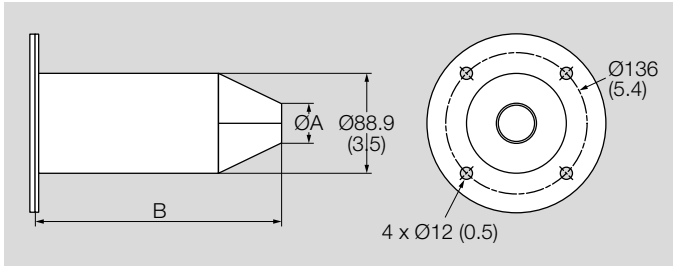

Weight: 2.1 lbs (0.95 kg)

Max. chamber temp: 1750°F (950°C) [Not suitable for pre-heated air over 700°F (371°C)]

#### Silicon Carbide Combustor

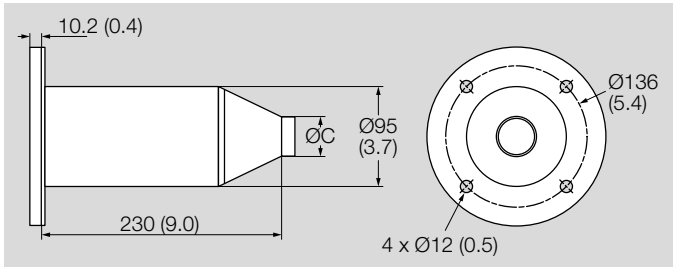

Weight: 3.6 lbs (1.6 kg)

Max. chamber temp: TJ: 2500°F (1371°C), TJPCA: 2200°F (1200°C)

Velocity	ØA mm (inch)	B mm (inch)	ØC mm (inch)
High	Ø45.4 (1.8)	212.6 (8.4)	Ø52 (2.0)
Medium/TJPCA	Ø63.4 (2.5)	193.3 (7.6)	Ø70 (2.8)

#### Refractory Combustor with AISI 330 wrapper

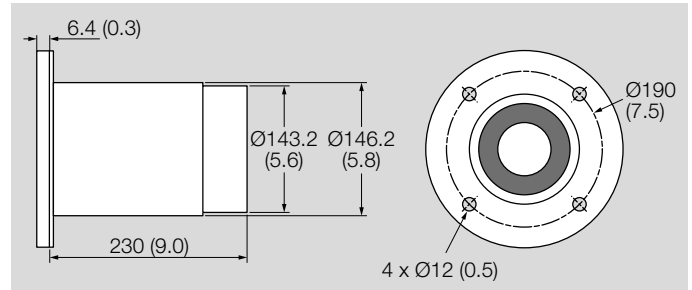

Dimensions in mm (inches)

Weight: 14 lbs (6.4 kg)

Max. chamber temp: 2800°F (1538°C)

**NOTE:** Mounting gasket shown on right side of combustor flange. Dimensions shown do not account for mounting gasket.

### 5.8.3 TJ/TJPCA0050–0075

#### Alloy Combustor (AISI 310)

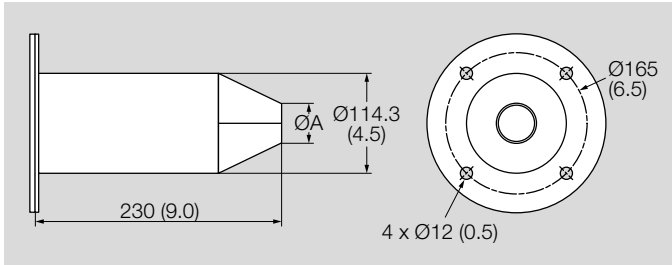

Weight: 3.0 lbs (1.4 kg)

Max. chamber temp: 1750°F (950°C) [Not suitable for pre-heated air over 700°F (371°C)]

#### Silicon Carbide Combustor

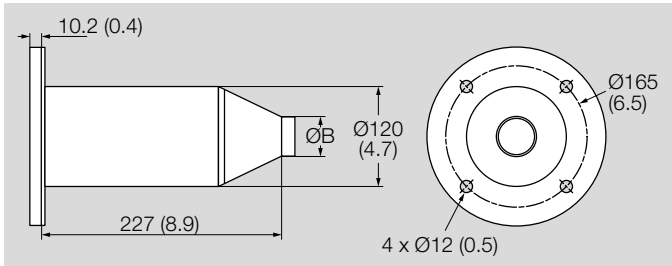

Weight: 3.3 lbs (1.5 kg)

Max. chamber temp: TJ: 2500°F (1371°C), TJPCA: 2200°F (1200°C)

Type	Velocity	ØA mm (inch)	ØB mm (inch)
TJ0050	High	Ø44.5 (1.8)	Ø51 (2.0)
TJ/TJPCA0050	Medium	Ø57 (2.2)	Ø63.5 (2.5)
TJ0075	High	Ø57 (2.2)	Ø63.5 (2.5)
TJ/TJPCA0075	Medium	Ø77.5 (3.1)	Ø84 (3.3)

#### Refractory Combustor with AISI 330 wrapper

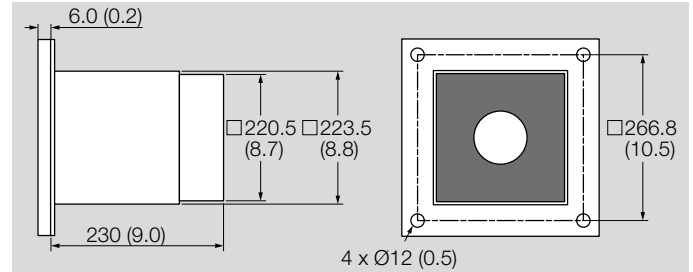

Weight: 62.5 lbs (28.3 kg)

Max. chamber temp: 2800°F (1538°C)

#### Down Firing Block with AISI 330 wrapper

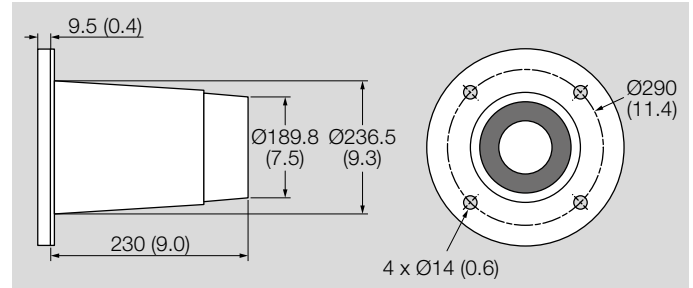

Dimensions in mm (inches)

Weight: 60 lbs (27.2 kg)

Max. chamber temp: 2800°F (1538°C)

**NOTE:** Mounting gasket shown on right side of combustor flange. Dimensions shown do not account for mounting gasket.

5.8.4 TJ/TJPCA0100–0150

Alloy Combustor (AISI 310)

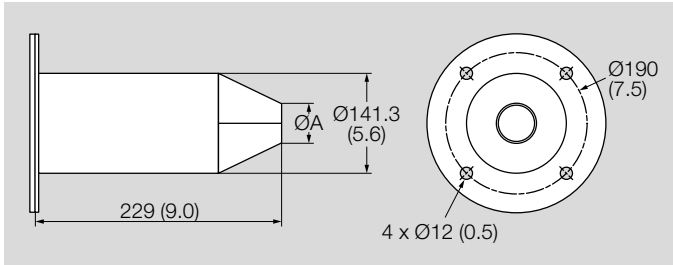

Weight: 3.3 lbs (1.5 kg)

Max. chamber temp: 1750°F (950°C) [Not suitable for pre-heated air over 700°F (371°C)]

Silicon Carbide Combustor

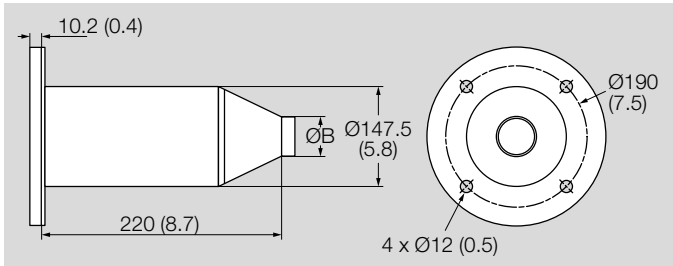

Weight: 3.1 lbs (1.4 kg)

Max. chamber temp: TJ: 2500°F (1371°C), TJPCA: 2200°F (1200°C)

Type	Velocity	ØA mm (inch)	ØB mm (inch)
TJ0100	High	Ø57.8 (2.3)	Ø64 (2.5)
TJ/TJPCA0100	Medium	Ø80.2 (3.2)	Ø86.5 (3.4)
TJ0150	High	Ø67.3 (2.7)	Ø73.5 (2.9)
TJ/TJPCA0150	Medium	Ø92.7 (3.7)	Ø99 (3.9)

Refractory Combustor with AISI 330 wrapper

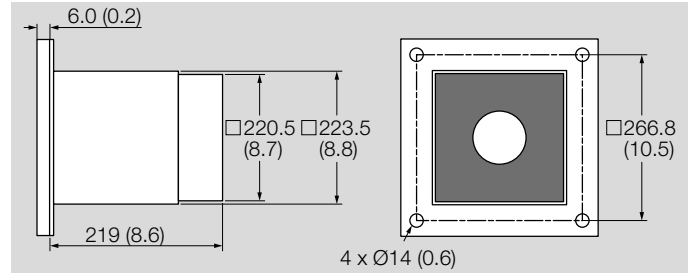

Weight: 58.3 lbs (26.5 kg)

Max. chamber temp: 2800°F (1538°C)

Down Firing Block with AISI 330 wrapper

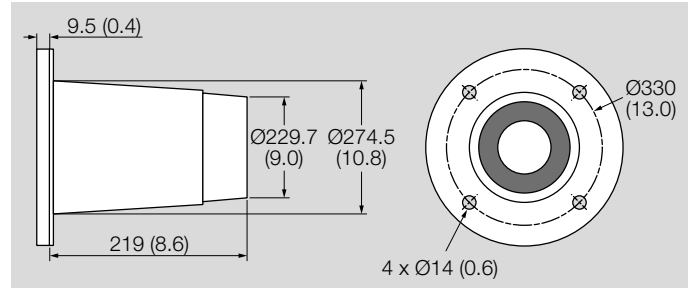

Dimensions in mm (inches)

Weight: 75 lbs (34 kg)

Max. chamber temp: 2800°F (1538°C)

**NOTE:** Mounting gasket shown on right side of combustor flange. Dimensions shown do not account for mounting gasket.

### 5.8.5 TJ/TJPCA0200

#### Alloy Combustor (AISI 310)

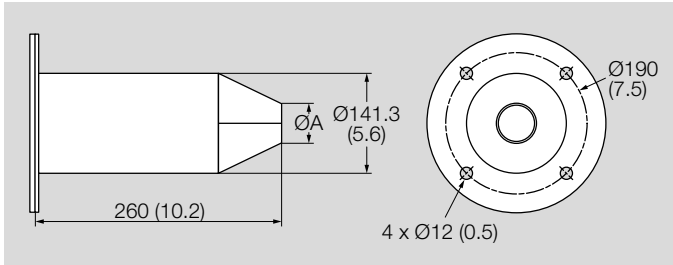

Weight: 4.2 lbs (1.9 kg)

Max. chamber temp: 1750°F (950°C) [Not suitable for pre-heated air over 700°F (371°C)]

#### Silicon Carbide Combustor

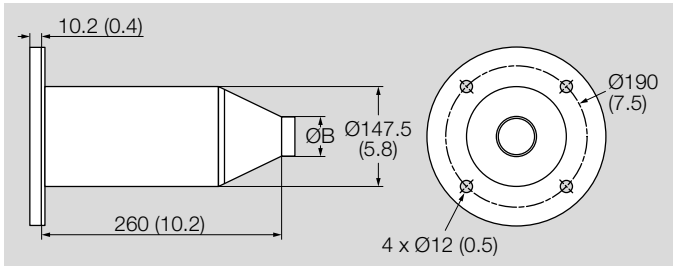

Weight: 3.1 lbs (1.5 kg)

Max. chamber temp: TJ: 2500°F (1371°C), TJPCA: 2200°F (1200°C)

Velocity	ØA mm (inch)	ØB mm (inch)
High	Ø85 (3.3)	Ø85 (3.3)
Medium/TJPCA	Ø105 (4.1)	Ø115 (4.5)

#### Refractory Combustor with AISI 330 wrapper

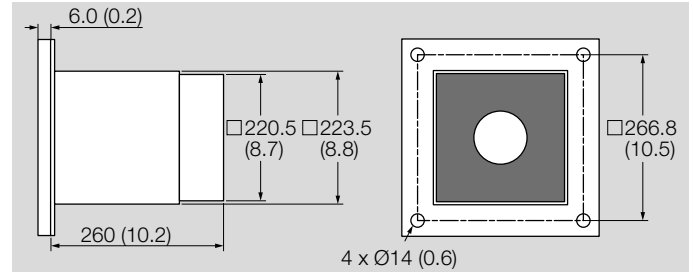

Weight: 66 lbs (30 kg)

Max. chamber temp: 2800°F (1538°C)

#### Down Firing Block with AISI 330 wrapper

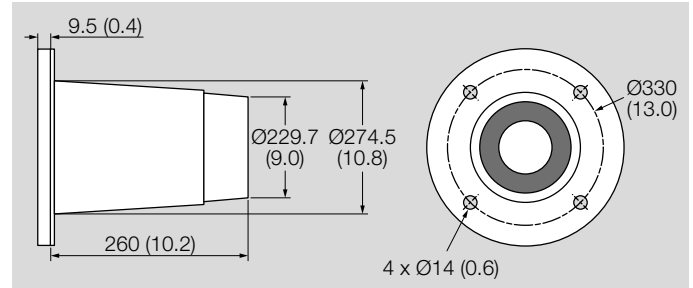

Dimensions in mm (inches)

Weight: 77 lbs (35 kg)

Max. chamber temp: 2800°F (1538°C)

**NOTE:** Mounting gasket shown on right side of combustor flange. Dimensions shown do not account for mounting gasket.

### 5.8.6 TJ/TJPCA0300

#### Alloy Combustor (AISI 310)

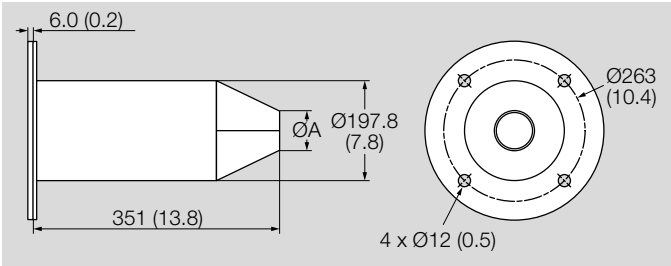

Weight: 13.5 lbs (6 kg)

Max. chamber temp: 1750°F (950°C) [Not suitable for pre-heated air over 700°F (371°C)]

Velocity	$\varnothing A$ mm (inch)
High	$\varnothing 103.4$ (4.1)
Medium/TJPCA	$\varnothing 138.5$ (5.5)

#### Refractory Combustor with AISI 330 wrapper

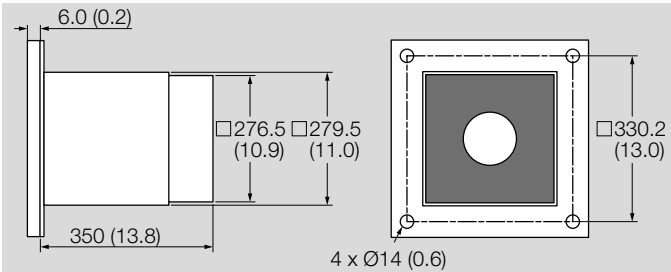

Weight: 131.4 lbs (60 kg)

Max. chamber temp: 2800°F (1538°C)

#### Down Firing Block with AISI 330 wrapper

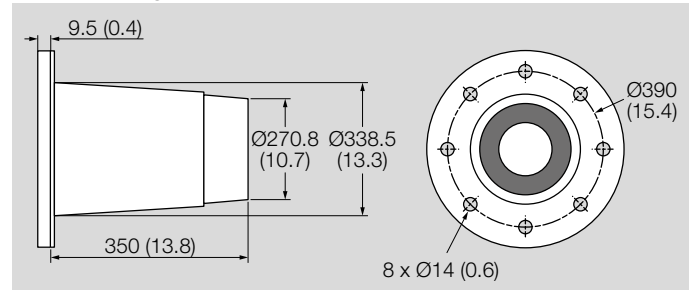

Dimensions in mm (inches)

Weight: 135 lbs (61 kg)

Max. chamber temp: 2800°F (1538°C)

**NOTE:** Mounting gasket shown on right side of combustor flange. Dimensions shown do not account for mounting gasket.

### 5.8.7 TJ/TJPCA0500

#### Alloy Combustor (AISI 310)

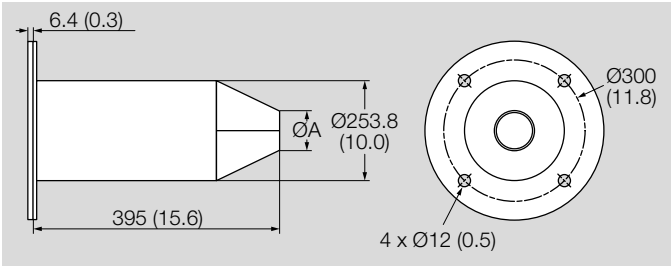

Weight: 14.5 lbs (6.6 kg)

Max. chamber temp: 1750°F (950°C) [Not suitable for pre-heated air over 700°F (371°C)]

Velocity	ØA mm (inch)
High	Ø128 (5.1)
Medium/TJPCA	Ø180 (7.1)

#### Refractory Combustor with AISI 330 wrapper

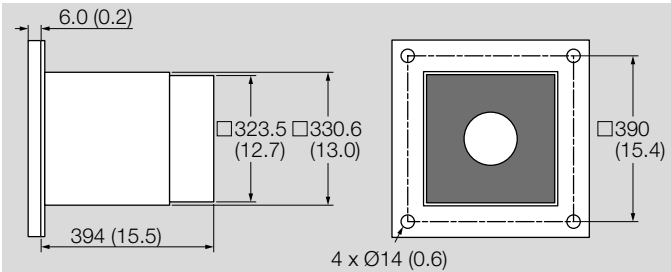

Weight: 160 lbs (73 kg)

Max. chamber temp: 2800°F (1538°C)

#### Down Firing Block with AISI 330 wrapper

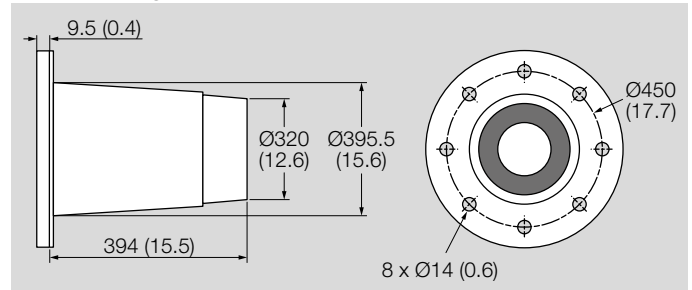

Dimensions in mm (inches)

Weight: 184 lbs (83.9 kg)

Max. chamber temp: 2800°F (1538°C)

**NOTE:** Mounting gasket shown on right side of combustor flange. Dimensions shown do not account for mounting gasket.



**5.8.8 TJ/TJPCA0750–1000  
Alloy Combustor (AISI 310)**

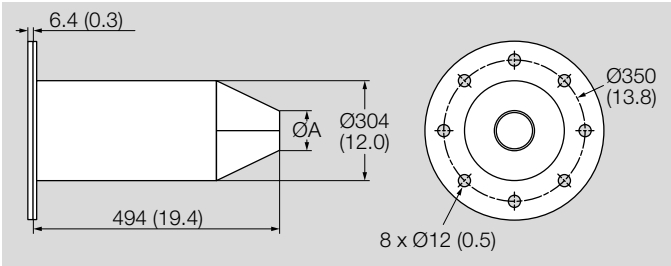

Weight: 21 lbs (9.5 kg)

Max. chamber temp: 1750°F (950°C) [Not suitable for pre-heated air over 700°F (371°C)]

Type	Velocity	ØA mm (inch)
TJ0750	High	Ø159 (6.2)
TJ/TJPCA0750	Medium	Ø224 (8.8)
TJ1000	High	Ø223 (8.8)
TJ/TJPCA1000	Medium	Ø253 (10.0)

**Refractory Combustor with AISI 310 wrapper**

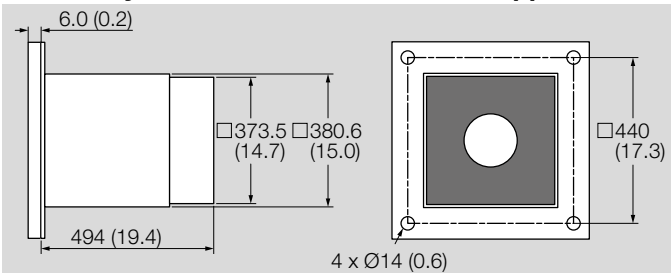

Weight: 310 lbs (141 kg)

Max. chamber temp: 2800°F (1538°C)

**Down Firing Block with AISI 310 wrapper**

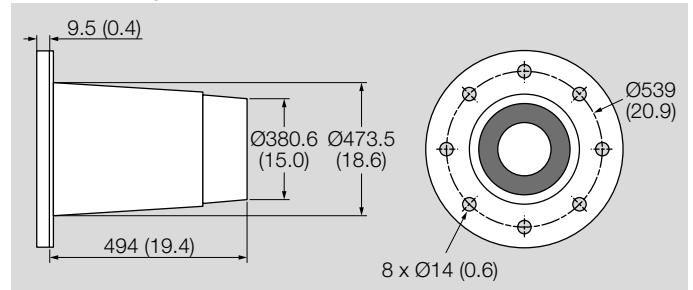

Dimensions in mm (inches)

Weight: 290 lbs (132 kg)

Max. chamber temp: 2800°F (1538°C)

**NOTE:** Mounting gasket shown on right side of combustor flange. Dimensions shown do not account for mounting gasket.

### 5.8.9 TJ/TJPCA1500–2000

#### Alloy Combustor (AISI 310)

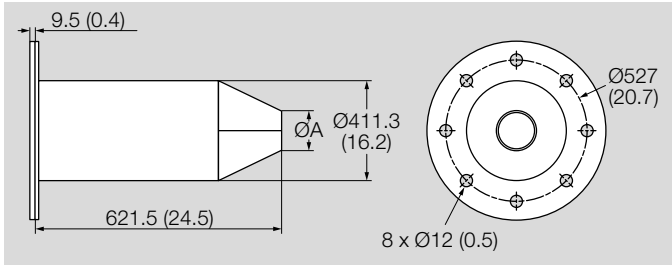

Weight: 44 lbs (20 kg)

Max. chamber temp: 1750°F (950°C) [Not suitable for pre-heated air over 700°F (371°C)]

Type	Velocity	ØA mm (inch)
TJ1500	High	Ø223 (8.8) (tapered)
TJ/TJPCA1500	Medium	Ø409 (16.1) (straight)
TJ2000	High	Ø263 (10.4) (tapered)
TJ/TJPCA2000	Medium	Ø409 (16.1) (straight)

#### Refractory Combustor with AISI 330 wrapper

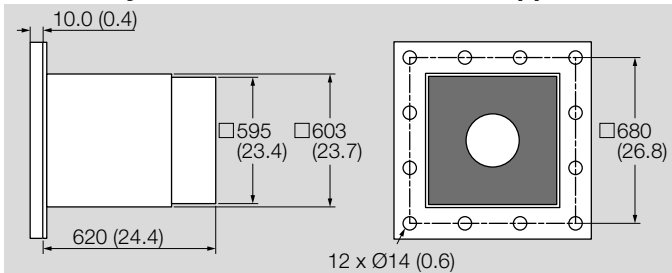

Weight: 1000 lbs (454 kg)

Max. chamber temp: 2800°F (1538°C)

#### Down Firing Block with AISI 330 wrapper

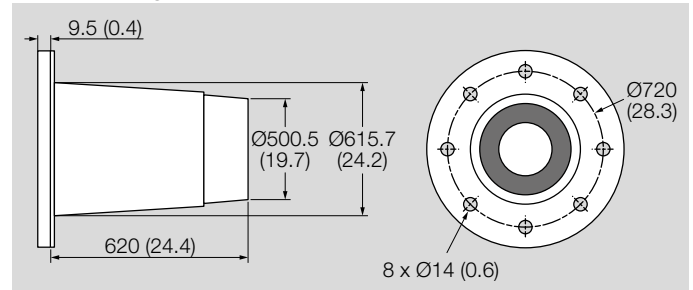

Dimensions in mm (inches)

Weight: 610 lbs (277 kg)





Max. chamber temp: 2800°F (1538°C)





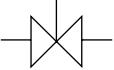
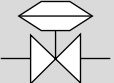
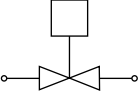

**NOTE:** Mounting gasket shown on right side of combustor flange. Dimensions shown do not account for mounting gasket.

## **6 Converting units**

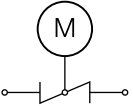
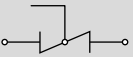
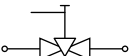
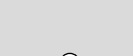
See [www.adlatus.org](http://www.adlatus.org)

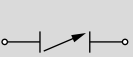
## 7 System Schematics

Symbol	Name	Remarks
	Gas Cock	Gas cocks are used to manually shut off the gas supply.
	Ratio Regulator	A ratio regulator is used to control the air/gas ratio. The ratio regulator is a sealed unit that adjusts the gas flow in ratio with the air flow. To do this, it measures the air pressure with a pressure sensing line, the impulse line. This impulse line is connected between the top of the ratio regulator and the air supply line. The cap must stay on the ratio regulator after adjustment.
Main Gas Shut-Off Valve Train	Main Gas Shut-Off Valve Train	Honeywell strongly endorses NFPA 756 as a minimum.
Pilot Gas Shut-Off Valve Train	Pilot Gas Shut-Off Valve Train	Honeywell strongly endorses NFPA 756 as a minimum.
	Automatic Shut-Off Valve	Shut-off valves are used to automatically shut off the gas supply on a gas system or a burner.
	Orifice Meter	Orifice meters are used to measure flow.
	Combustion Air Blower	The combustion air blower provides the combustion air to the burner(s).
	Hermetic Booster	Booster is used to increase gas pressure.

Symbol	Name	Remarks
	Automatic Butterfly Valve	Automatic butterfly valves are typically used to set the output of the system.
	Manual Butterfly Valve	Manual butterfly valves are used to balance the air or gas flow at each burner.
	Adjustable Limiting Orifice	Adjustable limiting orifices are used for fine adjustment of gas flow.
	Pressure Switch	A switch activated by rise or fall in pressure. A manual reset version requires pushing a button to transfer the contacts when the pressure set point is satisfied.
	Pressure Gauge	A device to indicate pressure
	Check Valve	A check valve permits flow only in one direction and is used to prevent back flow of gas.
	Strainer	A strainer traps sediment to prevent blockage of sensitive components downstream.
	Flexible Connector	Flexible connectors isolate components from vibration, mechanical, and thermal stresses.
	Heat Exchanger	Heat exchangers transfer heat from one medium to another.
	Pressure Taps	Pressure taps measure static pressure. The schematics show the advised positions of the pressure taps.

## For more information

The Honeywell Thermal Solutions family of products includes Honeywell Combustion Safety, Eclipse, Exothermics, Hauck, Kromschroder and Maxon. To learn more about our products, visit [ThermalSolutions.honeywell.com](https://ThermalSolutions.honeywell.com) or contact your Honeywell Sales Engineer.

Honeywell Eclipse branded products

201 E 18th Street

Muncie, IN 47302

USA

[ThermalSolutions.honeywell.com](https://ThermalSolutions.honeywell.com)

© 2023 Honeywell International Inc.

We reserve the right to make technical modifications in the interests of progress.

