

Honeywell

MAXON

MAXON Series 8000 Pneumatic Shut-off Valves

INSTRUCTION MANUAL



Please read the operating and mounting instructions before using the equipment. Install the equipment in compliance with the prevailing regulations.



Bedrijfs- en montagehandleiding voor gebruik goed lezen! Apparaat moet volgens de geldende voorschriften worden geïnstalleerd.



Lire les instructions de montage et de service avant utilisation! L'appareil doit impérativement être installé selon les réglementations en vigueur.



Betriebs- und Montageanleitung vor Gebrauch lesen! Gerät muß nach den geltenden Vorschriften installiert werden.

European Sales Office

BELGIUM

MAXON International BVBA Luchthavenlaan 16-18

1800 Vilvoorde, Belgium

Tel: 32.2.255.09.09

Fax: 32.2.251.82.41



32M-95003-05

INSTALLATION, OPERATION AND MAINTENANCE INSTRUCTIONS



The Installation, Operating and Maintenance Instructions contain important information that must be read and followed by anyone operating or servicing this product. Do not operate or service this equipment unless the instructions have been read. **IMPROPER INSTALLATION OR USE OF THIS PRODUCT COULD RESULT IN BODILY INJURY OR DEATH.**

DESCRIPTION

The Series 8000 Valve is a pneumatically operated fuel shut-off valve. These valves require compressed air for actuation. The 8000 Series valve will open or close by the addition of a control voltage signal. Removal of the signal will cause a fast acting return to the at rest position. Options are available in both normally-closed and normally-open versions.

Series 8*1* Normally-Closed will shut off flow when de-energized and pass flow when energized.





Series 8*2* Normally-Open will shut off flow when energized and pass flow when de-energized.

The Series 8000 Valve has optional configurations that meet hazardous locations.

The Series 8000 Valve has fire safe trim configurations that meet API 6FA.

NAMEPLATE AND ABBREVIATIONS

Consult the nameplate on your valve. This lists the maximum operating pressure, temperature limitations, voltage requirements and service conditions of your specific valve. Do not exceed nameplate ratings.

Abbreviation or Symbol	Description
M.O.P. or MOPD (PS)	Maximum Operating Pressure or Maximum Operating Pressure Differential
P _{ACT}	Required actuator pressure
T _{S(AMB)}	Ambient service temperature range
T _{S(FL)}	Fluid service temperature range
	Visual indication determined by text, color and symbol; valve is shown in open position
	Visual indication determined by text, color and symbol; valve is shown in closed position
	Valve is shut
	Valve is partially open
	Valve is full open
VOS-1/2	Valve open switch(es)
VCS-1/2	Valve closed switch(es); proof of closure

Component identification

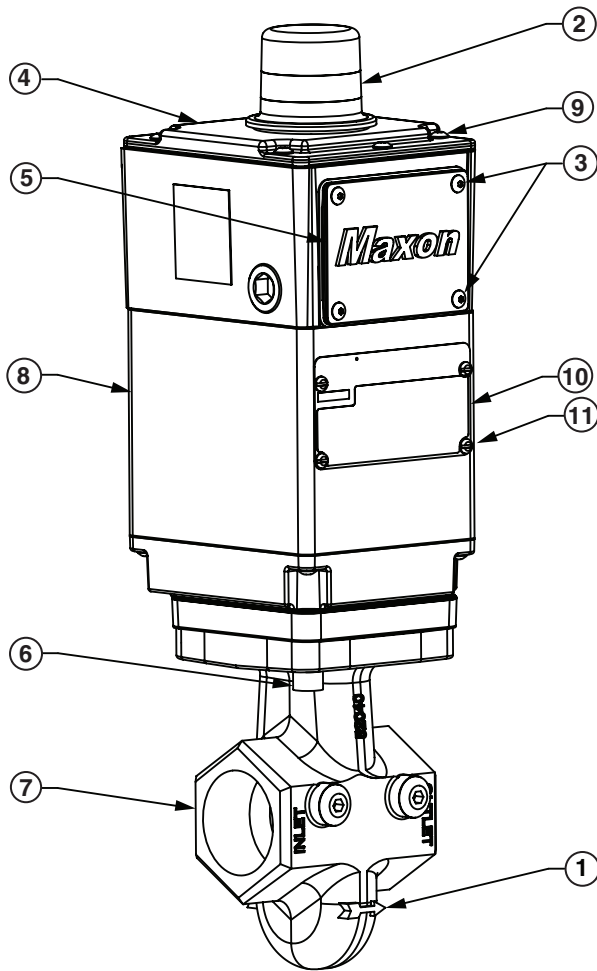

1)	Flow arrow
2)	Visual indication
3)	Terminal block cover screws, M5 x 12
4)	Switch access cover
5)	Terminal block cover
6)	Actuator bolts, M8 x 45 or M10 x 1.50
7)	Valve body
8)	Actuator
9)	Switch access cover screws, M6 x 20
10)	Nameplate
11)	Nameplate screws, M4 x 6

Installation

1. A gas filter or strainer of 40 mesh (0.6 mm maximum) or greater is recommended in the fuel gas piping to protect the downstream safety shut-off valves.
2. Properly support and pipe the valve in the direction of the flow arrow on the valve body. Valve seats are directional. Sealing will be maintained at full rated pressures in one direction only. Sealing will be provided in reverse flow only at reduced pressures.
3. Series 8000 Valves require clean, dry compressed air or gas piped to the inlet of the actuator. Guidelines for various actuating gases:
 - A. Compressed Air
 - a. The vent, located on the underside of the base plate, should be protected from blockage or piped to a better location.
 - b. Although MAXON Series 8000 Valves do not require lubrication, they do contain Buna-N (-40°F) or silicone (-58°F) seals in the actuator sub-assembly. Compressed air supply must not contain any lubricant that is not compatible with Buna-N or silicone elastomers. MAXON recommends ISO 8573.1 class 3 for oil and particulates, and the dew point to be below the lowest end use temperature.
 - B. Natural gas and other fuel gases can be used to actuate the Series 8000 Valve when the appropriate considerations are taken into account.
 - a. Apply only the Intrinsically Safe Series 8000 Valve for the application. The general purpose and non-incendive options are not suitable for fuel gas activation.
 - b. The activating fuel gas must be clean and free of moisture. The Series 8000 actuator contains Buna-N elastomers and brass, aluminum and stainless steel components that will come in contact with the activating gas. The gas must not contain any constituents that are incompatible with these materials. Actuating gas must meet the quality stds mentioned above in section 3.A.b.
 - c. The exhaust gas must be vented to the atmosphere in a safe manner by piping from the filtered vent, located on the underside of the actuator's base. A 1/8" NPT female connection in the base plate allows for proper piping.
 - d. The use of fuel gases for actuation is not permitted in EC areas due to ATEX Zone 2 restrictions.

- e. Actuators for fuel gas activation are only rated from -40°F to 140°F.
- C. For applications that are governed by the ATEX Directive (2014/34/EU), use of fuel gas activation is not acceptable.
- 4. In some instances, it may be desired to utilize a slow opening feature for either application or code-related reasons. If a slow opening feature is required for normally-closed shut-off valves, use MAXON’s optional speed control set.
- 5. Wire the valve in accordance with all applicable local and national codes and standards. In U.S. and Canada, wiring must conform to the NEC ANSI/NFPA 70 and/or CSA C22.1, Part 1.
 - A. Supply voltages must agree with valve’s nameplate voltage within -15%/+10% for proper operation. For electrical wiring schematic, see instructions or sample affixed inside valve terminal block cover.
 - B. Grounding is achieved with a grounding screw, which is located in the top assembly.
 - C. Customer connections are provided via terminal block located in the top assembly.
 - D. Main power wiring (120 VAC or 240 VAC) must be segregated from lower voltage 24 VDC signal wiring, when both are required.
 - E. WARNING: For Division 2 installations using the intrinsically safe solenoid, the power source is not to exceed 28VDC with a minimum series resistance of 300 ohms.
- 6. Maintain integrity of the Series 8000 actuator enclosure by using the appropriate electrical connectors for the (2) 3/4” NPT conduit threaded connections. The Series 8000 electrical enclosure is NEMA 4 and IP65 rated with an option for NEMA 4X.
 - A. To eliminate any potential for gas to enter the electrical wiring system, install a conduit seal fitting at the actuator conduit hub.
- 7. All access cover plate screws should be tightened using an alternate cross-corner tightening pattern to the values shown in Table 1.
- 8. Verify proper installation and operation by electrically actuating the valve for 10–15 cycles prior to the first introduction of gas.
- 9. When customer-supplied, externally mounted solenoids are used, the component must be rated for the Class and Division, or Zone of the hazardous area.
- 10. Do not test or use MAXON Gas Valves with liquids
 - A. MAXON Gas Valves are constructed for gas usage only, and any liquid used in the pipeline will collect in the valve body and can seriously affect function.

Table 1 - Torque Specifications

Item Number	Description	Torque
3	Terminal Block Cover Screws, M5 x 12	20 in-lbs
9	Switch Access Cover Screws, M6 x 20	20 in-lbs
6	Actuator Bolts, M8 x 45	13 ft-lbs
6	Actuator Bolts, M10 x 1.50	13 ft-lbs
11	Nameplate Screws, M4 x 6	10 in-lbs

SPECIFICATIONS

Valve Body Assemblies									
Valve Size	Flow Capacity	Actuator Pressure Class	Body Connections Available ¹	Body Material	Cv Rating	Flow Rate ² $\frac{\text{cfh}}{\text{m}^3 \text{ h}}$	MOP/MOPD $\frac{\text{psig}}{\text{bar}}$		
.75" (DN 20)	Std.	High Pressure	A, C	Iron	19	1060 / 30	200/13.8		
			A, C, E, F, G	Steel			255/17.6		
				Stainless					
1" (DN 25)	Std.	High Pressure	A, C	Iron	20	1115 / 31	200/13.8		
			A, C, E, F, G	Steel			255/17.6		
				Stainless					
1.25" (DN 32)	Std.	High Pressure	A, C	Iron	45	2510 / 71	200/13.8		
1.5" (DN 40)	Std.	High Pressure	A, C	Iron	53	2956 / 83	200/13.8		
			A, C, E, F, G	Steel			255/17.6		
				Stainless					
2" (DN 50)	Std.	High Pressure	A, B, C, D, H	Iron	86	4796 / 135	200/13.8		
			A, C, E, F, G	Steel			255/17.6		
				Stainless					
2.5" (DN 65)	Std.	High Pressure	A, B, C, D, H	Iron	127	7083 / 200	150/10.3		
			CP	Std			A, B, C, D, H	Iron	304
	B, D, H	Steel							
		High Pressure		A, B, C, D, H			Iron	175/12.1	
	B, D, H						Steel		
		Stainless							
3" (DN 80)	Std.		High Pressure	A, C	Iron	173	9648 / 273	150/10.3	
		CP		Std	A, B, C, D, H			Iron	423
	B, D, H		Steel						
			High Pressure	A, B, C, D, H	Iron			135/9.3	
	B, D, H				Steel				
		Stainless							
4" (DN 100)	CP		Std.	B, D, H	Iron	490	27328 / 773	40/2.7	
		High Pressure			Steel				
	Stainless								
	Iron		135/9.3						
	Steel								
	Stainless								
6" (DN 150)		Std.	B, D, H	Iron	1172	65364 / 1850	60/4.1		
	High Pressure			Steel					
		Stainless							
		Iron		100/6.9					
		Steel							
	Stainless								
8" (DN 200)		Std.	B, D, H, J	Steel	1320	73406 / 2078	60/4.1		
	High Pressure			Stainless					
		Steel		100/6.9					
		Stainless							
		Stainless							

1 Body Connections

A - NPT
 B - ANSI 150 lb Flange (ISO 7005 PN 20)
 C - ISO Threaded
 D - DIN PN16 Flange

E - Socket Welded Nipple
 F - Socket Welded Nipple w/ANSI 150 lb flange (ISO 7005 PN20)
 G - Socket Welded Nipple w/ANSI 300 lb flange (ISO 7005 PN50)
 H - EN 1092-1 PN16 (ISO 7005-1 PN16)
 J - ANSI Class 300 Flange (ISO 7005 PN50)

² Flow for Natural Gas (S.G. 0.60) at differential pressure = 1" wc and standard temperature (68°F) and pressure (14.696 psi)

OPERATING CHARACTERISTICS

- Opening time varies with valve size, air pressure, temperature, and fuel pressure. Typically about 3 seconds for larger sizes and down to approximately 1 second for smaller valves. For slower opening, a speed control set can be supplied by MAXON.

- Closing time is less than 1 second for all sizes, regardless of application parameters.
- Recommended Construction Options for Common Types of Gas

Gas	Gas Code	Suggested Material Options			MOPD Rating	Agency Approvals and Certifications			
		Seals & Bumper	Body & Bonnet ⁷	Trim Option ⁵		FM	CSA ³	CE ⁴	
								GAD ⁶	PED ⁷
Air	AIR	A, B, C, F	1, 2, 5, 6	1, 2, 3, 6, 7	Std.	X	X		X
Ammonia	AMM	A, C, F	1, 2, 5, 6	1, 2, 3, 6, 7	Std.	X			X
Butane Gas	BUT	A, B, F	1, 2, 5, 6	1, 2, 3, 6, 7	Std.	X	X	X	X
Coke Oven Gas	COKE	B, F	5	Analysis Required	Std.	X			X
Digester ¹	DIG	Analysis Required	5	Analysis Required	Std.	X			X
Endothermic AGA	ENDO	A, B, F	1, 2, 5, 6	1, 2, 3, 6, 7	Std.	X	X		X
Exothermic Gas	EXO	A, B, F	1, 2, 5, 6	1, 2, 3, 6, 7	Std.	X	X		X
Hydrogen Gas	HYD	A, B, C, F	1, 2, 5, 6	1, 2, 3, 6, 7	Reduced ²	X			X
Manufactured ¹	MFGD	Analysis Required	5	Analysis Required	Std.	X	X		X
Natural Gas	NAT	A, B, F	1, 2, 5, 6	1, 2, 3, 6, 7	Std.	X	X	X	X
Nitrogen	NIT	A, B, C, F	1, 2, 5, 6	1, 2, 3, 6, 7	Std.	X	X		X
Oxygen (High P)	OXYH	B, C, F	2, 5, 6	4, 5	200 psig	X			X
Oxygen (Low P)	OXYL	B, C, F	1, 2, 5, 6	4, 5	30 psig	X			X
Oxygen X	OXYX	B, C, F	2, 5, 6	4, 5	Std.	X			X
Propane	PROP	A, B, F	1, 2, 5, 6	1, 2, 3, 6, 7	Std.	X	X	X	X
Refinery ¹	REF	Analysis Required	5	Analysis Required	Std.	X			X
Sour Natural Gas ¹	SOUR	Analysis Required	5	Analysis Required	Std.	X			X
Town Gas ¹	TOWN	Analysis Required	5	Analysis Required	Std.	X	X	X	X
Land Fill Gas ¹	LAND	Analysis Required	5	Analysis Required	Std.	X			X

Notes:

¹ Other body and trim packages may be acceptable pending fuel analysis. For pricing inquiries, Viton or Omniflex o-rings should be used. Contact MAXON for details.

² Valve maximum operating pressure differential (MOPD) to be reduced by 25% from standard ratings.

³ ISO connections are not recognized by CSA or UL standards.

⁴ 8000 Series electro-pneumatic valves meet the essential requirements of the Low Voltage - LVD (2014/35/EU), Gas Appliances - GAR (2009/142/EC), and Pressure Equipment - PED (2014/68/EU) Directives.

⁵ Trim Option 1 is only allowed with Body and Bonnet Option 1.

⁶ The Gas Appliance Regulation only covers the use of commercially available fuels (natural gas, butane, town gas and propane).

⁷ PED certification limited to 1-1/2" through 4" valves with steel or stainless steel body options (2, 5, 6). Body option 2 has a min ambient temp of -20°F.

Body Seals:

A - Buna-N B - Viton
C - Ethylene Propylene
F - Omniflex

Body & Bonnet:

1 - Cast Iron
2 - Carbon Steel
5 - Stainless Steel
6 - Low Temp Carbon Steel

Trim Package:

1 - Trim Package 1
2 - Trim Package 2
3 - Trim Package 3 (NACE)
4 - Trim Package 2, Oxy Clean
5 - Trim Package 3, Oxy Clean
6 - Trim 2 fire safe
7 - Trim 3 fire safe

AUXILIARY FEATURES











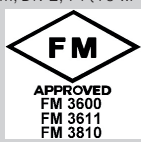









- Non-adjustable Proof of Closure Switch(es) with valve seal over travel interlock.
- Auxiliary switch for indication of full travel (open for normally-closed valves, closed for normally-open valves).





OPERATING ENVIRONMENT

- Fluid temperature range of -40°F to 212°F , with options available for -58°F to 212°F.
- Actuators are rated for NEMA 4, IP65 or optional NEMA 4X, IP65.
- Ambient temperature range of -40°F to 140°F for the 8011, 8111, 8021 and 8121 General Purpose and 8012, 8112, 8022 and 8122 Non-Incendive series valves; option of -58°F to 140°F also available. Intrinsically safe coil option on the Non-Incendive valves, is -40°F to 122°F. Low temp option -58°F to 122°F also available.
- Ambient temperature range of -40°F to 122°F for 8013, 8113, 8023 and 8123 Intrinsically Safe series valves; option of -58°F to 122°F also available.
- All valves for oxygen service or using Ethylene Propylene body seals are limited to a minimum ambient and fluid temperature of 0°F.

AGENCY APPROVALS AND CERTIFICATIONS

(Will vary with specific options selected)

	General Purpose Valves 8111, 8121, 8011, 8021 Series		Non-Incendive/Non-Sparking Valves 8112, 8122, 8012, 8022 Series		Intrinsically Safe Valves 8113, 8123, 8013, 8023 Series	
	Standards	Markings	Standards	Markings	Standards	Markings
FM Approvals	FM 7400		FM 3611 FM 3600 FM 3810 NEMA 250 IEC 60529	Class I, Div 2, Groups ABCD, T4 (T5 w/ IS coil) Class II, Div 2, Groups FG, T4 (T5 w/ IS coil) Class III, Div 2, T4 (T5 w/ IS coil) 	FM 3610 FM 3600 FM 3810 NEMA 250 IEC 60529	Class I, Div 1, Groups ABCD, T5 Class II, Div 1, Groups EFG, T5 Class III, Div 1, T5 
CSA/SIRA Approvals-IECEx Certification	Not Applicable	None	IEC 60079-0 IEC 60079-15 IEC 60079-31	IECEx SIR 19.0017X Ex nA nC IIC T4 Gc (T5 w/ IS coil) -40°C ≤ Ta ≤ 60°C (50°C max w/ IS coil) Ext c IIC T135°C Dc IP65	IEC 60079-0 IEC 60079-11	IECEx SIR 19.0017X Ex ia IIC T5 Gb Ext c IIC T135°C Dc -50°C ≤ Ta ≤ 50°C
CSA International	CSA 6.5	 	CSA Std. C22.2: No. 0-M91 No. 25-1966 No. 94-M91 No. 213-M1987 CAN/CSA-E60079-0 CAN/CSA-E60079-15 IEC 60529	Class I, Div 2, Groups ABCD, T4 Class II, Div 2, Groups FG, T4 Class III, Div 2, T4 Ex nA IIC T4 Ta = 60C (w/ std coil) Ex nA IIC T5 Ta = 50C (w/ IS coil) (Zone 2 approval)  	CSA Std. C22.2: No. 0-M91 No. 25-1966 No. 94-M91 No. 157-M1992 CAN/CSA-E60079-0 CAN/CSA-E60079-11 IEC 60529	Class I, Div 1, Groups ABCD, T5 Class II, Div 1, Groups EFG, T5 Class III, Div 1, T5 Ex ia IIC T5, -50°C ≤ Ta ≤ 50°C (Zone 0 Approval)  
United Kingdom GAR, LVD Compliance ¹	BS EN 161 BS EN 13774 TP 6.16		BS EN 161 BS EN 13774 TP 6.16		BS EN 161 BS EN 13774 TP 6.16	
European GAR, LVD Compliance ¹	BS EN 161 BS EN 13774 TP 6.16		BS EN 161 BS EN 13774 TP 6.16		BS EN 161 BS EN 13774 TP 6.16	
United Kingdom Approvals (Hazardous Locations) ²	Not Applicable	None	Not Applicable	None	EN IEC 60079-0 EN 60079-11	CSAE 21UKEX4438X II 2GD Ex ia IIC T5 Gb Ex ia IIIC T100°C Db Ta = -50°C to +50°C IP65 
European Approvals (Hazardous Locations) ²	Not Applicable	None	Not Applicable	None	EN IEC 60079-0 EN 60079-11	Sira 19ATEX2040X II 2GD Ex ia IIC T5 Gb Ex ia IIIC T100°C Db Ta = -50°C to +50°C IP65  
United Kingdom PED Compliance ¹						
European PED Compliance ¹						
IEC Approvals	IEC 61010-1 IEC 61508	None	IEC 61010-1 IEC 61508	None	IEC 61010-1 IEC 61508	None
NCC/Inmetro	Not Applicable	None	ABNT NBR: IEC 60079-0 IEC 60079-15 IEC 60079-31	Ex nA nC IIC T4 Gc (T5 w/ I.S. Coil) Ext c IIC T135°C Dc IP65 -40°C ≤ Ta ≤ +60°C (+50°C w/ I.S. Coil)   Ex nA nC IIC T4 Gc -50°C ≤ Ta ≤ +60° Ex nA nC IIC T5 Gc -50°C ≤ Ta ≤ +50°C Ext c IIC T135°C Dc IP65 Ext c IIIC T135°C Dc IP65	ABNT NBR: IEC 60079-0 IEC 60079-11 IEC 60079-31	 Ex ia IIC T5 Gb -50°C ≤ Ta ≤ +50°C Ext c IIC T135°C Dc IP65
KTL	Not Applicable	None	Announcement No. 2010-36 of Ministry of Employment and Labor	Ex nA nC IIC T4 (-50°C ≤ Ta ≤ +60°C) 	Announcement No. 2010-36 of Ministry of Employment and Labor	Ex ia IIC T5 (-50°C ≤ Ta ≤ +50°C) 

	General Purpose Valves 8111, 8121, 8011, 8021 Series		Non-Incendive/Non-Sparking Valves 8112, 8122, 8012, 8022 Series		Intrinsically Safe Valves 8113, 8123, 8013, 8023 Series	
	Standards	Markings	Standards	Markings	Standards	Markings
AGA Certifications	AS 4629	None	AS 4629	None	AS 4629	None
EAC Certifications	RUC-BE. AM30.B.00711		Not Applicable	None	TP TC 012/2011 ГОСТ 31610.0-2014 (IEC 60079-0) ГОСТ 31610.11-2014 (IEC 60079-11) ГОСТ Р МЭК (IEC 60079-31)	 RUC-US.AЖ58.B.01684/21
Chinese Approvals	None	None	GB 3836.1 GB 3836.8 GB 12476.1 GB 12476.5	 Ex nA nC IIC T4 Gc (T5 w/ IS coil) -50°C < Ta < +60°C (+50°C w/ IS coil) Ex tD A22 IP65 T135°C	GB 3836.1 GB 3836.4 GB 12476.1 GB 12476.5	 Ex ia IIC T5 Gb -50°C < Ta < +50°C Ex tD A22 IP65 T135°C

¹ Product complies with the essential requirements of the following: Gas Appliance Regulation (EU) 2016/426, Low Voltage Directive (2014/35/EU), and Pressure Equipment Directive (2014/68/EU) up to 4"

² Product certified to meet the following: ATEX Directive 2014/34/EU Class A, Group 2 per EN 161

VALVE CYCLE REQUIREMENTS

This is based on the standards that MAXON valves are approved to and the corresponding minimum number of cycles to be completed without failure as shown in the chart below.

	CSA (CSA 6.5)	FM (FM 7400)	European (EN161)
Automatic - Normally-Closed Series 8011, 8111, 8012, 8112, 8013, 8113	100,000	20,000	<= 1" 200,000 <= 3" 100,000 <= 8" 50,000
Vent Valves Series 8021, 8121, 8022, 8122, 8023, 8123	No special requirements	No special requirements	No special requirements

VALVE MODEL NUMBER DESCRIPTION

Every MAXON Series 8000 Valve can be accurately identified by the model number shown on the valve nameplate. The example below shows a typical Series 8000 Valve model number, along with the available choices for each item represented in the model number. The first five choices determine the valve's configured item number. Valve body and actuator options are identified by the next nine characters in the model number. Options and accessories are listed on the next page.

Configured Item Number					Valve Body					Actuator					
Valve Size	Flow Capacity	Pressure Rating	Normal Position	Area Classification	Body Connection	Body Seals	Body Material	Internal Trim Package	Primary Voltage	Switch Option	Enclosure Rating	Instruction Language	Visual Indication		
300	C	81	1	1	-	A	A	1	1	-	B	1	A	1	1

Valve Size

075 – 3/4" (DN 20)
 100 – 1" (DN 25)
 125 – 1-1/4" (DN 32)
 150 – 1-1/2" (DN 40)
 200 – 2" (DN 50)
 250 – 2-1/2" (DN 65)
 300 – 3" (DN 80)
 400 – 4" (DN 100)
 600 – 6" (DN 150)
 800 – 8" (DN 200)

Flow Capacity

S – Standard
 C – CP Body Construction

Operating Pressure Rating

80 – Pneumatic Standard Pressure
 81 – Pneumatic High Pressure

Normal Position

1 – Normally-Closed Shut-Off Valve
 2 – Normally-Open Vent Valve

Area Classification

1 – General Purpose
 2 – Non-incendive, Class I, II and III Division 2
 3 – Intrinsically Safe, Class I, II and III Division 1 (and ATEX Zone 1/21 when ordered with the ATEX IS solenoid) ¹
 4 – Valve Body Only

Body Connection

A – NPT
 B – ANSI Flanged (ISO 7005 PN 20)
 C – ISO 7-1 Threaded
 D – DIN PN 16 Flanged
 E – Socket Welded Nipple
 F – Socket Welded Nipple w/Class 150 Flange (ISO 7005 PN 20)
 G – Socket Welded Nipple w/Class 300 Flange (ISO 7005 PN 50)
 H – EN1092-1 PN16 (ISO 7005-1 PN16)
 J – ANSI Class 300 Flange (ISO 7005 PN 50)
 U – Actuator Only

Body Seals

A – Buna-N
 B – Viton
 C – Ethylene Propylene ²
 F – Omniflex ⁵
 X – Special
 U – Actuator Only

Body Material

1 – Cast Iron
 2 – Carbon Steel
 5 – Stainless Steel
 6 – Low Temp Carbon Steel
 X – Special
 U – Actuator Only

Internal Trim Package

1 – Trim Package 1
 2 – Trim Package 2
 3 – Trim Package 3 (NACE)
 4 – Trim Package 2 + oxy clean ²
 5 – Trim Package 3 + oxy clean ²
 6 – Trim Package 2 + fire safe
 7 – Trim Package 3 + fire safe
 X – Special ²
 U – Actuator Only

Primary Voltage ⁴

A – 120VAC 50Hz
 B – 120VAC 60Hz
 D – 240VAC 50Hz
 E – 240VAC 60Hz
 G – 24VDC
 H – 24VDC IS ¹
 J – 24VDC IS-ATEX ¹
 X – Special
 Z – None (customer-supplied, external mount) ³

Switch Option ⁴

0 – None
 1 – VOS1/VCS1 - V7
 2 – VOS2/VCS2 - V7
 3 – VOS1/VCS1 - IP67
 4 – VOS2/VCS2 - IP67
 X – Special

Enclosure Rating ⁴

A – NEMA 4, IP65
 B – NEMA 4X, IP65
 X – Special

Instruction Language ⁴

0 – English
 1 – French
 3 – German
 4 – Portuguese
 5 – Spanish

Visual Indication ⁴

1 – Red closed/green open
 2 – Green closed/red open
 3 – Black closed/yellow open

¹ 122°F maximum ambient temperature limit

² 0°F minimum ambient temperature limit

³ FM Approvals not applicable

⁴ Not a selection on Body Only

⁵ Omniflex seals mandatory with -58°F fuel temperature option

Options and accessories

Certifications ¹							Inspections			
Material Cert Required	Casting Inspection Specification	Casting Inspection (NDE) 1	Casting Inspection (NDE) 2	Weld Inspection Specification	Weld Inspection (NDE) 1	Weld Inspection (NDE) 2	Pre-build Material FAT	Final Verification FAT	Redundant Solenoid	Speed Control
N	1	1	1	1	1	0	N	N	1	2

Material Cert Required

N – No
Y – Yes

Casting Inspection Specification

0 – None
1 – Casting per ASME B31.1
2 – Casting per ASME B31.3
3 – Casting per ASME B16.34
4 – MSS-SP55

Casting Inspection (NDE) 1 ¹

0 – None
1 – Liquid Penetrant Inspection (PT)
2 – Magnetic Particle Inspection (MT)
4 – Positive Material Identification (PMI)

Casting Inspection (NDE) 2 ¹

0 – None
1 – Liquid Penetrant Inspection (PT)
2 – Magnetic Particle Inspection (MT)
4 – Positive Material Identification (PMI)

Weld Inspection Specification

0 – None
1 – Weld per ASME B31.1
2 – Weld per ASME B31.3

Weld Inspection (NDE) 1 ¹

0 – None
1 – Liquid Penetrant Inspection (PT)
2 – Magnetic Particle Inspection (MT)

Weld Inspection (NDE) 2 ¹

0 – None
1 – Liquid Penetrant Inspection (PT)
2 – Magnetic Particle Inspection (MT)

Pre-build Material FAT

N – No
X – Special

Final Verification FAT

N – No
X – Special

Redundant Solenoid ^{2,3}

0 – None
1 – External Redundant Solenoid
2 – External Redundant Manual Reset Solenoid

Speed Control ³

0 – None
1 – Speed Control Valve, Steel
2 – Speed Control Valve, Stainless Steel

¹ Material certifications provided for valve body, bonnet, pipe nipples (when applicable) and flanges (when applicable). Material certifications for other components may be available by special request.

² Agency approvals and certifications apply to valve only and do not apply to optional external accessories, such as redundant solenoids.

³ Not a selection on Body Only

ELECTRICAL DATA

Normally-Closed Shut-Off Valves

GENERAL PURPOSE NORMALLY-CLOSED VALVES

Series 8011 & Series 8111 Switches: V7

Solenoid Valve: Standard

24 VDC, 4.8W

120VAC, 50/60 Hz, 11/9.4 VA Peak, 8.5/6.9 VA Holding

240VAC, 50/60 Hz, 11/9.4 VA Peak, 8.5/6.9 VA Holding

See *Technical Catalog* or inside valve cover for wiring schematic.

NON-INCENDIVE NORMALLY-CLOSED VALVES

Series 8012 & Series 8112 Switches: IP67

Solenoid Valve: Standard

24 VDC, 4.8W

120VAC, 50/60 Hz, 11/9.4 VA Peak, 8.5/6.9 VA Holding

240VAC, 50/60 Hz, 11/9.4 VA Peak, 8.5/6.9 VA Holding

24VDC IS, .09A, 2.1W

INTRINSICALLY SAFE NORMALLY-CLOSED VALVES

Series 8013 & Series 8113

Switches: V7 with optional IP67

Solenoid Valve: Intrinsically Safe

NOTES:

- 1) The Intrinsic Safety Entity concept allows the interconnection of two FM approved (CSA Certified when installed in Canada) Intrinsically safe devices with entity parameters not specifically examined in combination as a system when:

$$V_{oc} \text{ or } U_o \text{ or } V_t \leq V_{max}, I_{sc} \text{ or } I_o \text{ or } I_t \leq I_{max}, C_a \text{ or } C_o \geq C_i + C_{cable}, L_a \text{ or } L_o \geq L_i + L_{cable}, \text{ and}$$

for FM only: $P_o \leq P_i$.

- 2) Dust-tight conduit seal must be used when installed in Class II and Class III environments.
- 3) Control equipment connected to the Associated Apparatus must not use or generate more than 250 Vrms or Vdc.
- 4) Installation in the U.S. should be in accordance with ANSI/ISA RP12.06.01 "Installation of Intrinsically Safe Systems for Hazardous (Classified) Locations" and the National Electric Code® (ANSI/NFPA 70) Sections 504 and 505.
- 5) Installation in Canada should be in accordance with the Canadian Electrical Code, CSA C22.1, Part 1, Appendix F.
- 6) Installation in the European Union should be in accordance to Directive 2014/34/EU (ATEX).

- 7) The configuration of associated Apparatus must be FM Approved (CSA Certified when in Canada) under Entity Concept.
- 8) Associated Apparatus manufacturer's installation drawing must be followed when installing this equipment.
- 9) No revision to drawing without prior authorization from FM Approval and CSA International.

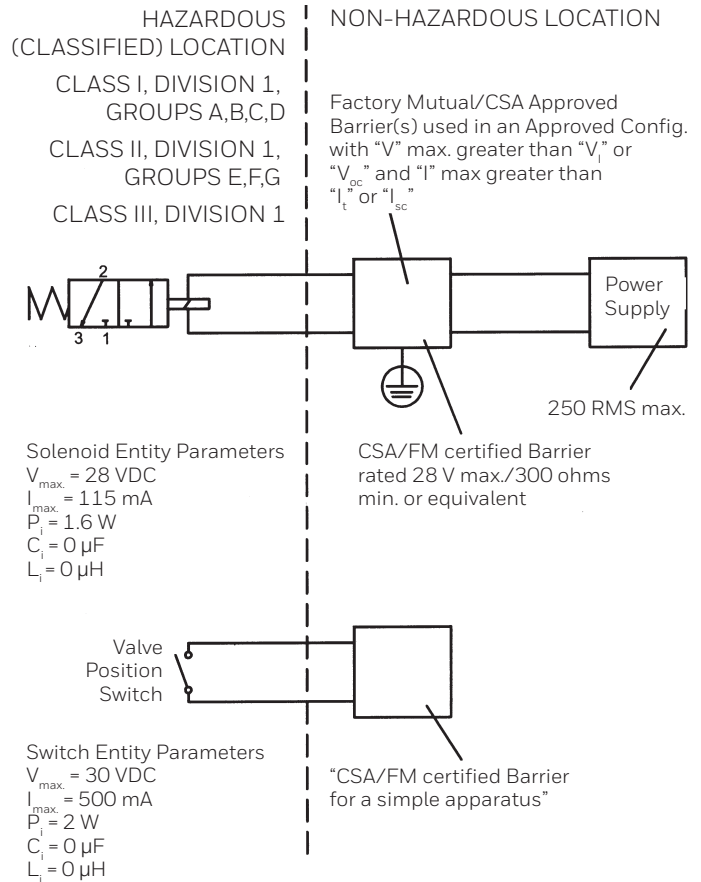

INTRINSICALLY SAFE NORMALLY-CLOSED VALVES

Series 8013 & Series 8113

Switches: V7 with optional IP67

Solenoid Valve: Customer-supplied, externally mounted

NOTES:

- 1) The Intrinsic Safety Entity concept allows the interconnection of two FM approved (CSA Certified when installed in Canada) Intrinsically safe devices with entity parameters not specifically examined in combination as a system when:
 V_{oc} or U_o or $V_t \leq V_{max}$, I_{sc} or I_o or $I_t \leq I_{max}$, C_a or $C_o \geq C_i + C_{cable}$, L_a or $L_o \geq L_i + L_{cable}$, and for FM only: $P_o \leq P_i$.
- 2) Dust-tight conduit seal must be used when installed in Class II and Class III environments.
- 3) Control equipment connected to the Associated Apparatus must not use or generate more than the maximum permissible safe area voltage (U_m) for the barrier.
- 4) Installation in the U.S. should be in accordance with ANSI/ISA RP12.06.01 "Installation of Intrinsically Safe Systems for Hazardous (Classified) Locations" and the National Electric Code® (ANSI/ NFPA 70) Sections 504 and 505.
- 5) Installation in Canada should be in accordance with the Canadian Electrical Code, CSA C22.1, Part 1, Appendix F.
- 6) Installation in the European Union should be in accordance to Directive 2014/34/EU (ATEX).
- 7) The configuration of associated Apparatus must be FM Approved (CSA Certified when in Canada) under Entity Concept.
- 8) Associated Apparatus manufacturer's installation drawing must be followed when installing this equipment.
- 9) No revision to drawing without prior authorization from FM Approval and CSA International.

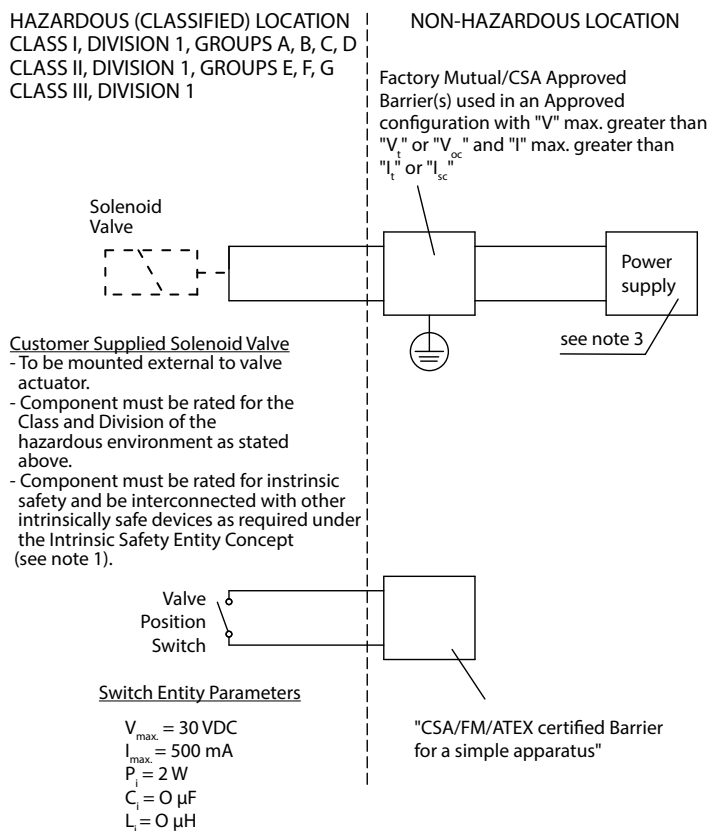

Normally-Open Vent Valves

GENERAL PURPOSE NORMALLY-OPEN VENT VALVES

Series 8021 & Series 8121 Switches: V7

Solenoid Valve: Standard

24 VDC, 4.8W

120VAC, 50/60 Hz, 11/9.4 VA Peak, 8.5/6.9 VA Holding

240VAC, 50/60 Hz, 11/9.4 VA Peak, 8.5/6.9 VA Holding

See *Technical Catalog* or inside valve cover for wiring schematic..

NON-INCENDIVE NORMALLY-OPEN VENT VALVES

Series 8022 & Series 8122 Switches: IP67

Solenoid Valve: Standard

24 VDC, 4.8W

120VAC, 50/60 Hz, 11/9.4 VA Peak, 8.5/6.9 VA Holding

240VAC, 50/60 Hz, 11/9.4 VA Peak, 8.5/6.9 VA Holding

24VDC IS, .09A, 2.1W

INTRINSICALLY SAFE NORMALLY-OPEN VENT VALVES

Series 8023 & Series 8123

Switches: V7 with optional IP67

Solenoid Valve: Intrinsically Safe

NOTES:

- 1) The Intrinsic Safety Entity concept allows the interconnection of two FM approved (CSA Certified when installed in Canada) Intrinsically safe devices with entity parameters not specifically examined in combination as a system when:

$$V_{oc} \text{ or } U_o \text{ or } V_t \leq V_{max}, I_{sc} \text{ or } I_o \text{ or } I_t \leq I_{max}, C_a \text{ or } C_o \geq C_i + C_{cable}, L_a \text{ or } L_o \geq L_i + L_{cable}, \text{ and for FM only: } P_o \leq P_i.$$

- 2) Dust-tight conduit seal must be used when installed in Class II and Class III environments.
- 3) Control equipment connected to the Associated Apparatus must not use or generate more than 250 Vrms or Vdc.
- 4) Installation in the U.S. should be in accordance with ANSI/ISA RP12.06.01 "Installation of Intrinsically Safe Systems for
- 5) Installation in Canada should be in accordance with the Canadian Electrical Code, CSA C22.1, Part 1, Appendix F.
- 6) Installation in the European Union should be in accordance to Directive 2014/34/EU (ATEX).
- 7) The configuration of associated Apparatus must be FM Approved (CSA Certified when in Canada) under Entity Concept.

- 8) Associated Apparatus manufacturer's installation drawing must be followed when installing this equipment.
- 9) No revision to drawing without prior authorization from FM Approval and CSA International.

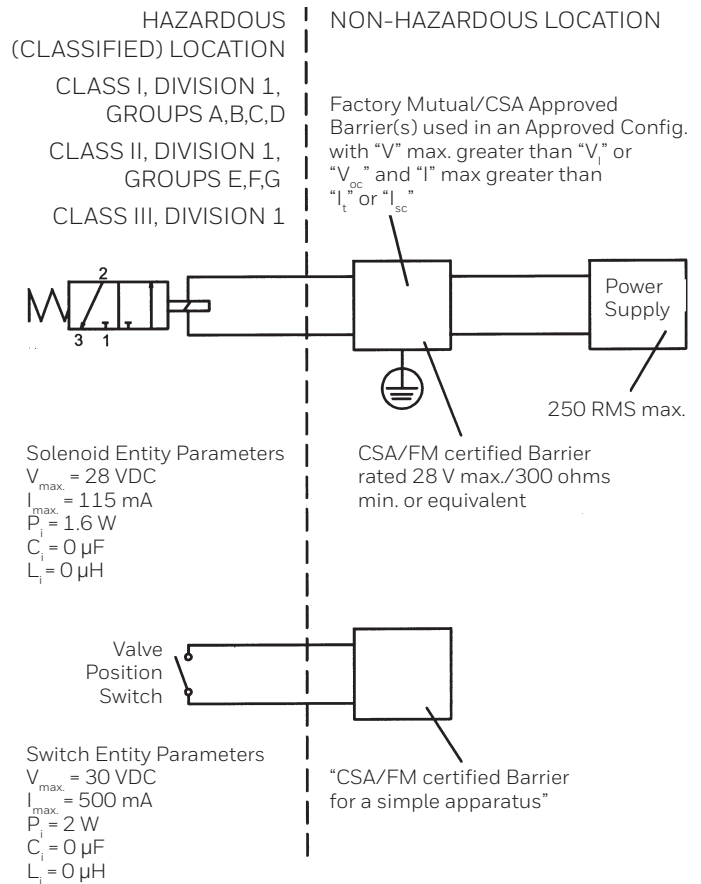

INTRINSICALLY SAFE NORMALLY-OPEN VENT VALVES

Series 8023 & Series 8123

Switches: V7 with optional IP67

Solenoid Valve: Customer-supplied, externally mounted

NOTES:

- 1) The Intrinsic Safety Entity concept allows the interconnection of two FM approved (CSA Certified when installed in Canada) Intrinsically safe devices with entity parameters not specifically examined in combination as a system when:

$$V_{oc} \text{ or } U_o \text{ or } V_t \leq V_{max}, I_{sc} \text{ or } I_o \text{ or } I_t \leq I_{max}, C_a \text{ or } C_o \geq C_i + C_{cable}, L_a \text{ or } L_o \geq L_i + L_{cable}, \text{ and for FM only: } P_o \leq P_i.$$

- 2) Dust-tight conduit seal must be used when installed in Class II and Class III environments.
- 3) Control equipment connected to the Associated Apparatus must not use or generate more than the maximum permissible safe area voltage (U_m) for the barrier.
- 4) Installation in the U.S. should be in accordance with ANSI/ISA RP12.06.01 "Installation of Intrinsically Safe Systems for Hazardous (Classified) Locations" and the National Electric Code® (ANSI/ NFPA 70) Sections 504 and 505.
- 5) Installation in Canada should be in accordance with the Canadian Electrical Code, CSA C22.1, Part 1, Appendix F.
- 6) Installation in the European Union should be in accordance to Directive 2014/34/EU (ATEX).
- 7) The configuration of associated Apparatus must be FM Approved (CSA Certified when in Canada) under Entity Concept.
- 8) Associated Apparatus manufacturer's installation drawing must be followed when installing this equipment.
- 9) No revision to drawing without prior authorization from FM Approval and CSA International.

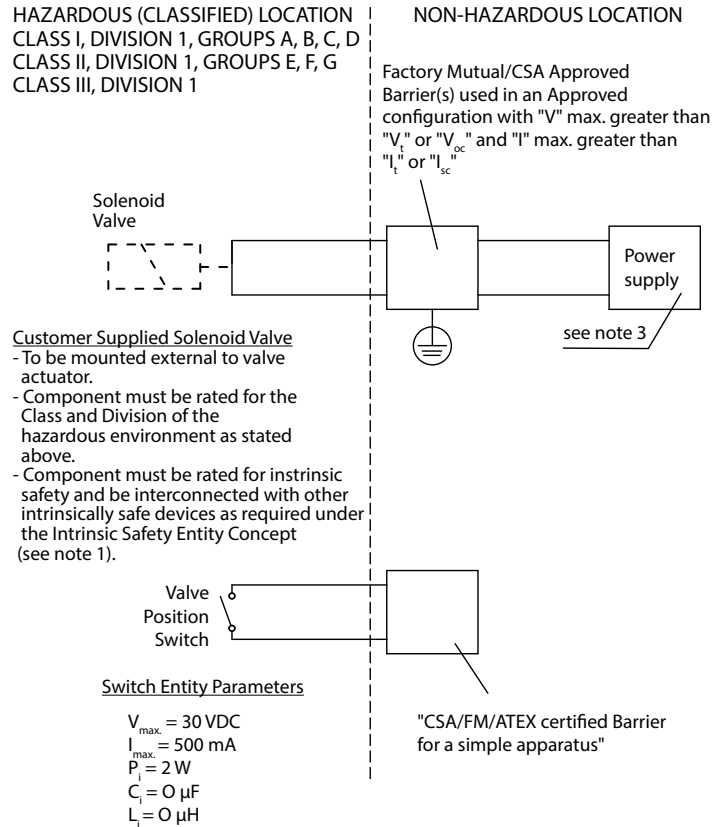

OPERATING INSTRUCTIONS

Refer to appropriate catalog page for operating features applying to your specific valve. Never operate valve until all essential allied equipment is operative and any necessary purges completed. Failure of valve to operate normally indicates that it is not powered or supply air pressure is not adequate. Check this first!

Main system shut-off should always be accomplished with an upstream leak-tight manual fuel cock.



The Series 8000 Pneumatic Safety Shut-off Valve is not intended to be used for end of line service.

Users are responsible for providing protection against surface temperatures.

Users are responsible for providing suitable protective devices to protect against over pressure conditions.

Users are responsible for limiting momentary pressure surges to within 10% of the maximum allowed pressure in accordance with the Pressure Equipment Directive.

- Normally-closed shut-off valves begin opening cycle immediately upon being powered.
- Normally-open vent valves begin to close immediately upon being powered.

When installing three valves in a double block and bleed application, sequence the operation so that the bleed (vent) valve is closed (VCS indicates closed) prior to opening the blocking valves. This will minimize loss of fuel through the vent during the actuation cycle.

ALTERNATE OPERATOR PRESSURES

Series 8000 Valves may be operated within a range of actuator pressures. Consult charts below for application fluid pressure and corresponding required actuator pressure.

**Pressure Required to Actuator
Series 8100: .75"-3"**

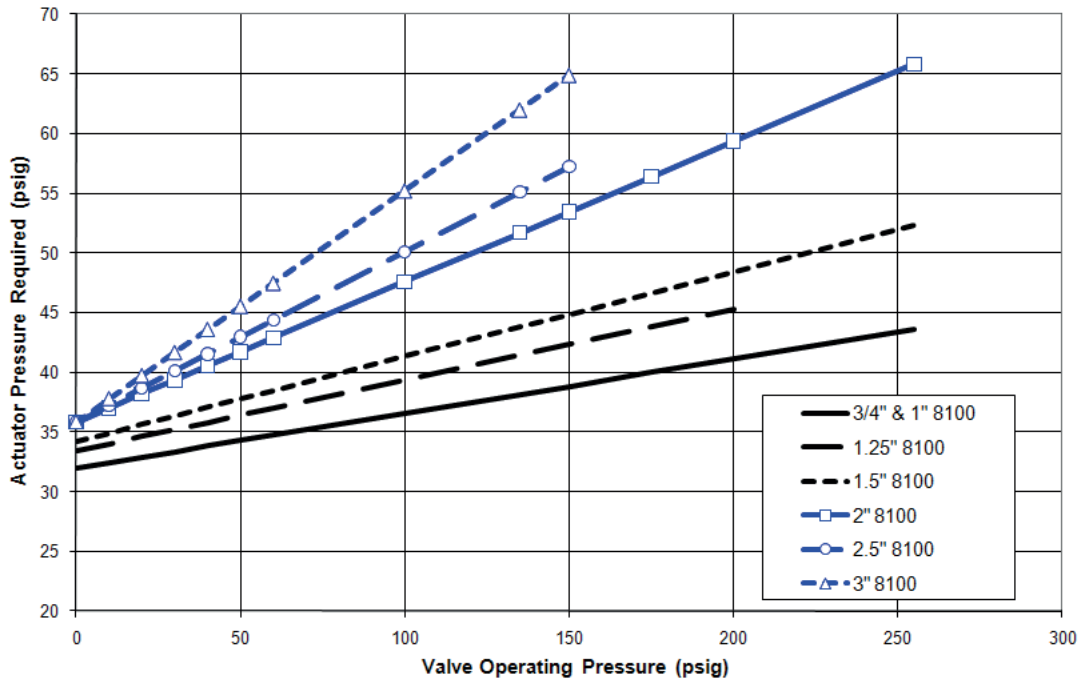

**Pressão requerida para o atuador
Série 8100: 2,5" CP, 3" CP, 4" CP**

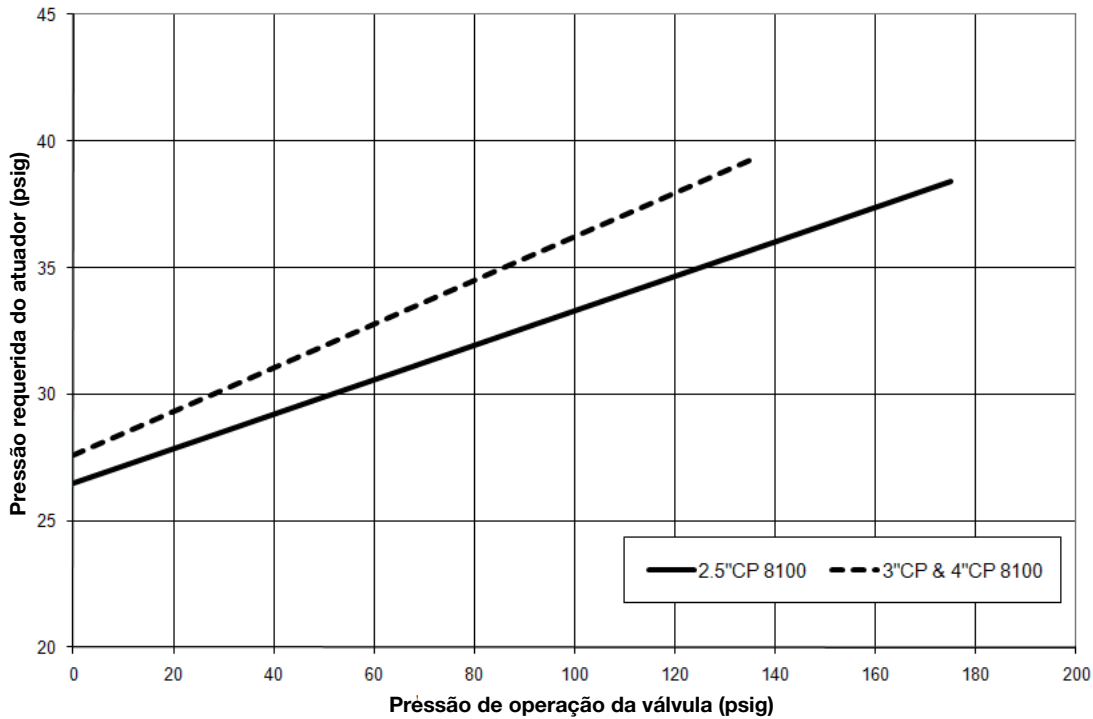

**Pressure Required to Actuator
Series 8000: 2.5"CP, 3"CP, 4"CP**

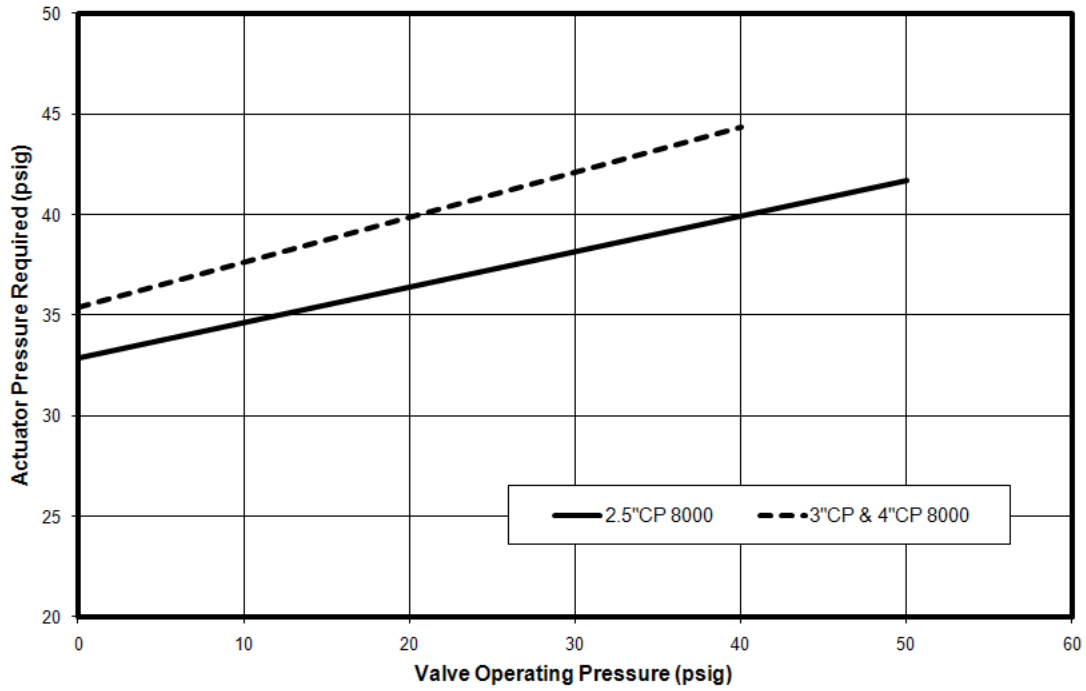

**Pressure Required to Actuator
6" & 8" Series 8000 & 8100**

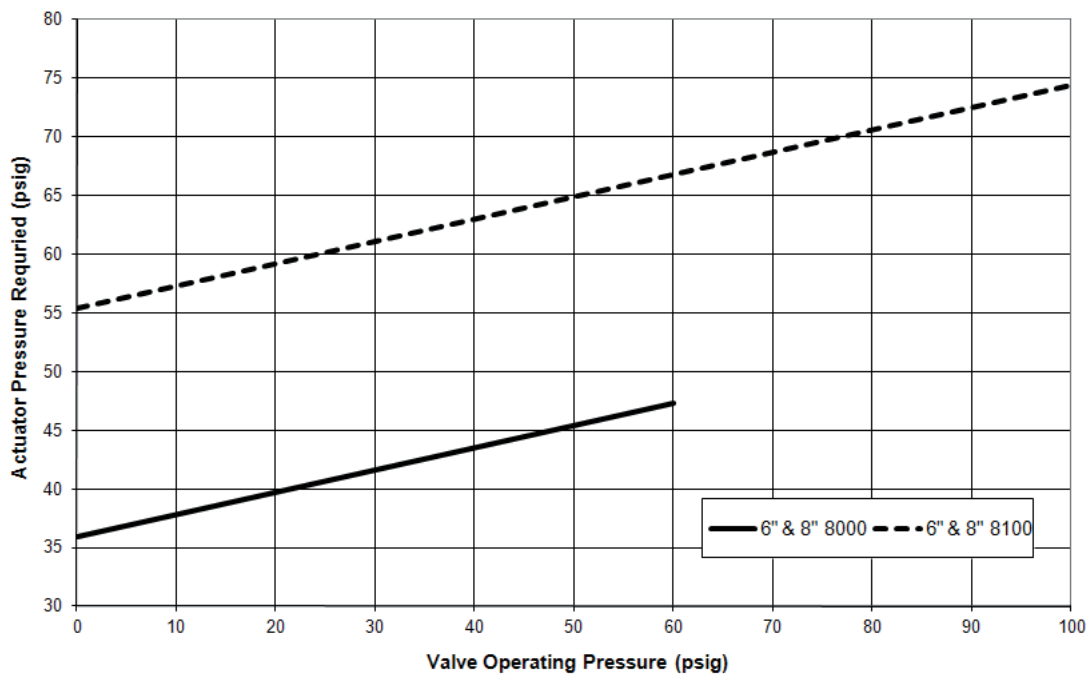

MAINTENANCE INSTRUCTIONS

MAXON Series 8000 Valves are endurance tested far in excess of the most stringent requirements of the various approval agencies. They are designed for long life even if frequently cycled, and to be as maintenance-free and trouble-free as possible.

A valve operational test should be performed on an annual basis. If abnormal opening or closing is observed, the valve should be removed from service and your MAXON representative should be contacted. (See [Valve Technical Data page 10-35.1](#).)

Valve leak test should be performed on an annual basis to assure continued safe and reliable operation. Every MAXON valve is operationally tested and meets the requirements of FCI 70-2 Class VI Seat Leakage when in good operable condition. Zero leakage may not be obtained in the field after it has been in service. For specific recommendations on leak test procedures, see MAXON [Valve Technical Data page 10-35.2](#). Any valve that exceeds the allowable leakage, as set forth by your local codes or insurance requirements, should be removed from service and your MAXON representative should be contacted.

Actuator assembly components require no field lubrication and should **never** be oiled.

Auxiliary switches, solenoids or complete actuator may be replaced in the field.



Do not attempt field repair of valve body or actuator. Any alterations void all warranties and can create potentially hazardous situations.

If foreign material or corrosive substances are present in the fuel line, it will be necessary to inspect the valve to make certain it is operating properly. If abnormal opening or closing is observed, the valve should be removed from service. Contact your MAXON representative for instructions.

Operator should be aware of and observe characteristic opening/closing action of the valve. Should operation ever become sluggish, remove valve from service and contact MAXON for recommendations.



Specific conditions of use:

This equipment includes some external non-metallic parts, including the outer protective coating. The user shall therefore ensure that the equipment is not installed in a location where it may be subjected to external conditions (such as high-pressure steam) which might cause a build-up of electrostatic charges on non-conducting surfaces. Additionally, cleaning of the equipment should be done only with a damp cloth.

Address inquiries to MAXON. Local worldwide offices may be located at www.maxoncorp.com or by phoning 011-765-284-3304.

Include valve serial number and nameplate information.

Solenoid replacement procedure

- All power sources, both pneumatic and electric, must be de-energized and follow all proper safety procedures prior to servicing valve.
- Use a 4 mm allen wrench to remove the top plate. A 3 mm allen wrench is used to remove the terminal block cover.
- Use a 5/16" open end wrench to hold the cylinder shaft, then use a pair of pliers to unthread the switch indicator from the cylinder shaft. When using pliers, grab the indicator from the top.

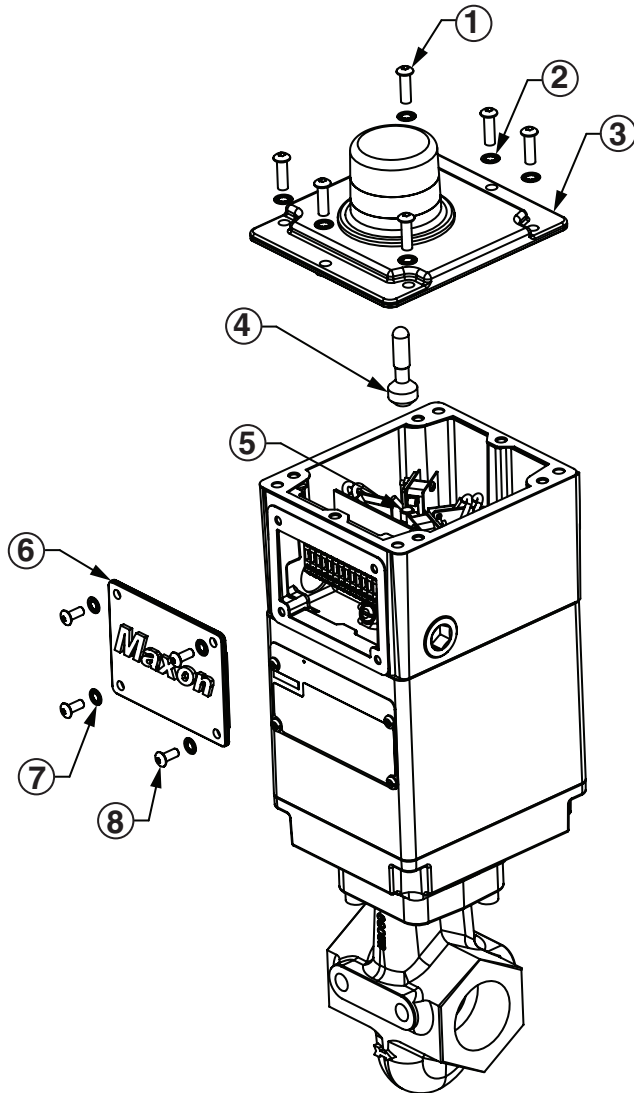

1)	Top plate screw M6 x 20 socket head cap screw
2)	M6 Lock washer
3)	Top plate
4)	Switch indicator
5)	Cylinder shaft
6)	Terminal block cover
7)	M5 Lock washer
8)	Terminal block cover screw M5 x 12 socket head cap screw

- Loosen the liquid tight connector nut where the solenoid wires come into the top housing. Remove #1 and #2 wire from the terminal block.

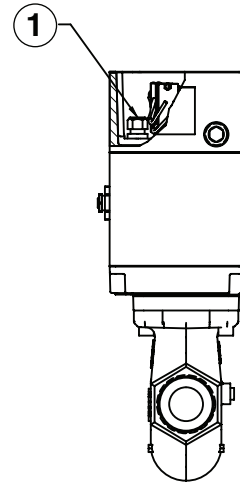

1) Liquid tight connector

- Use a 3/4" wrench to remove the solenoid inlet fitting. An adjustable wrench is used to loosen the housing collar. Slightly loosen the housing collar but do not remove, due to the nut and o-ring located inside the housing becoming dislocated.

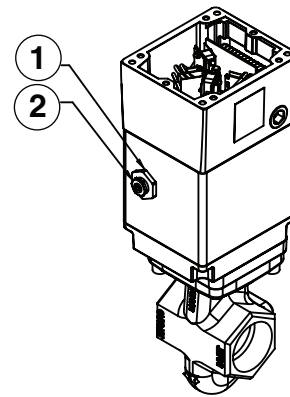

1) Housing collar
2) Solenoid inlet fitting

- Use a 4 mm allen wrench and remove the 4 screws that hold the housing to the base plate. Pull the housing straight up and remove. Old solenoid wires will pass through liquid tight connector.

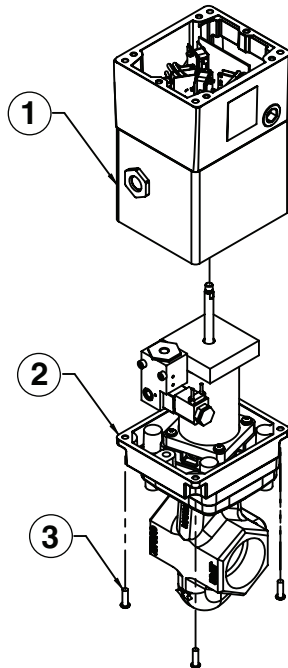

1)	Housing
2)	Base plate
3)	Housing screws M6 x 20 cap screws

- Use a 4 mm allen wrench and remove the 2 screws that hold the solenoid on. Replace the solenoid ensuring that there are 2 o-rings, one on the solenoid inlet and one on the solenoid outlet. The solenoid must be level when tightening screws.

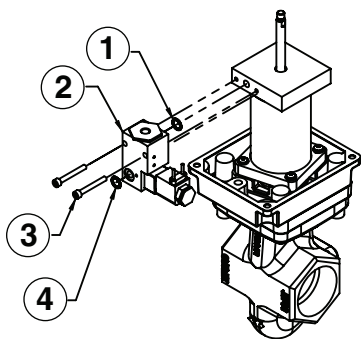

1)	Solenoid o-ring
2)	Solenoid
3)	M5 x 40 socket head cap screw
4)	Solenoid o-ring

- Run the new solenoid wires back up through the liquid tight connector in the housing and align the cylinder shaft with the hole in the housing. Carefully slide housing back into position. Replace the 4 housing screws and leave loose.
- Verify the o-ring is still on the solenoid inlet by looking through the housing collar. Reinstall solenoid inlet fitting tight. Leave the housing collar loose.
- Reinstall solenoid wire #1 and #2 back to the terminal block and tighten down the liquid tight connector nut.
- A locking sealant must be used on the cylinder shaft threads and then reinstall the switch indicator. Make sure to remove any locking sealant that runs down the cylinder shaft. Re-energize pneumatic and electric power and cycle the valve several times to ensure it operates smoothly. Tighten down the 4 housing screws that hold the housing to the base plate using a cross pattern (see torque values on page 4 (Table 1 - Torque Specifications)). Then tighten the housing collar on the solenoid inlet fitting. The o-ring under the housing collar must not be pinched while tightening the housing collar.
- Cycle valve several more times to see if it still operates smoothly. If not, loosen the 4 screws that hold the housing to the base plate and cycle again. Retighten the 4 housing screws. Put the top plate and terminal block covers back on valve (see torque values on page 4 (Table 1 - Torque Specifications)).

Actuator assembly rotation/replacement

! MAXON Series 8000 Valves should be ordered in a configuration compatible with planned piping. If valve orientation is not correct, the actuator assembly can be rotated in 90° increments around the valve body centerline axis using the procedure below. This procedure should also be followed for field replacement of the actuator.

- Shut off all electrical power and close off upstream manual cock.
- Remove terminal block access cover plate [4] and disconnect power lead wires. Caution: Label all wires prior to disconnection when servicing valve. Wiring errors can cause improper and dangerous operation.
- Remove conduit and electrical leads.
- Remove all pneumatic lines.
- Unscrew the actuator/body bolts [5] screwed up from the bottom. These bolts secure the valve actuator [7] to the valve body [6].
- Gently lift the actuator [7] off valve body assembly enough to break the seal between body assembly and the rubber gasket adhering to the bottom of the actuator base plate.
- Carefully rotate/replace actuator assembly to the desired position. Reposition the actuator back down onto the valve body casting.
- Realign holes in valve body casting with the corresponding tapped holes in the bottom of the actuator base plate. Be sure the gasket is still in place between the body and actuator base plate.
- Reinsert the body bolts up from the bottom through the body and carefully engage threads of the actuator assembly. Tighten securely referring to page 4 (Table 1 - Torque Specifications) for appropriate torque specifications.
- Reconnect conduit, electrical leads, and all pneumatic lines, then check that signal switch wands are properly positioned. Failure to correct any such misalignment can result in extensive damage to the internal mechanism of your valve.
- Energize valve and cycle several times from closed to full open position. Also electrically trip the valve in a partially opened position to prove valve operates properly.
- Replace and secure cover plates.
- Verify proper operation after servicing.

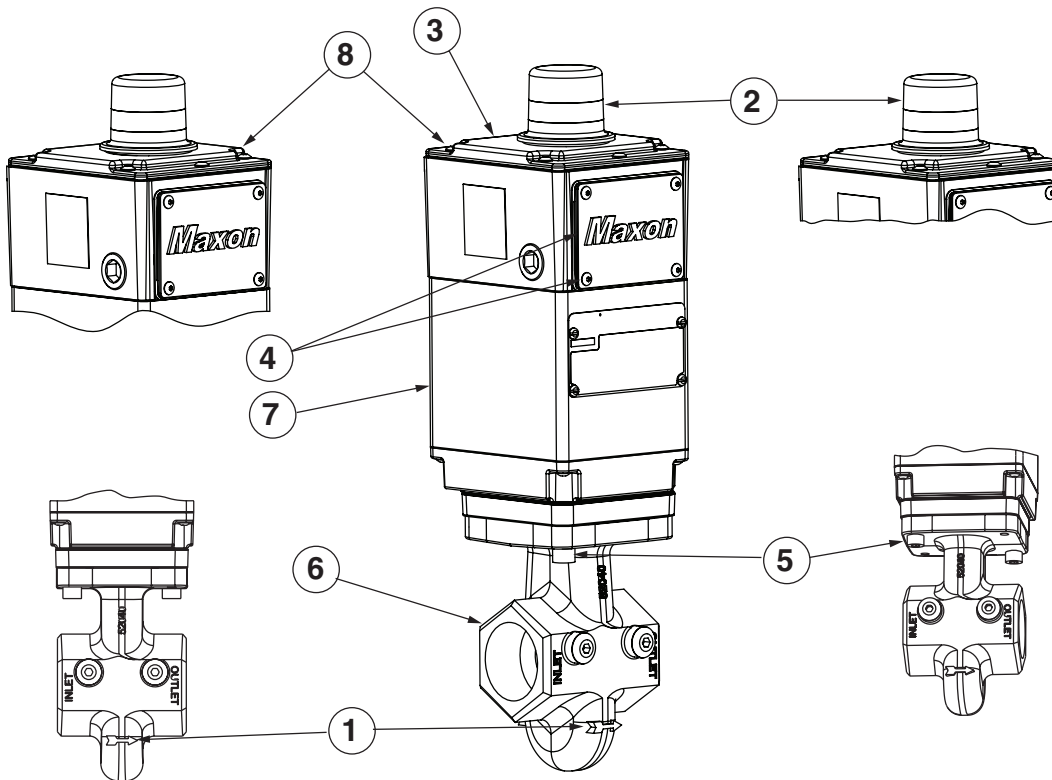

1)	Flow arrow on valve body
2)	Open/shut indicator (see Note 1)
3)	Switch access cover
4)	Terminal block cover and screws
5)	Actuator/body bolts
6)	Valve body
7)	Actuator assembly
8)	Switch access cover screws

Note 1: Open/Shut indication is 360°. If required, the observation window may be cleaned with a damp cloth.

Field installation of valve position switch

! Instructions below are written for normally-closed shut-off valves. For normally-open vent valves, reverse switch nomenclature. (VOS becomes VCS and vice versa.)

General: Shut off fuel supply upstream of valve, then de-energize valve electrically.

Remove top cover and terminal block cover to provide access, being careful not to damage gasket. See pages 23 (REPLACEMENT SWITCHES) or 24 (ADD SWITCHES) for instructions on adding or replacing switches.

! Substitution of components may affect suitability for Hazardous Locations.

FIELD REPLACEMENT ITEMS

- Position Switches
- Actuators
- Solenoids

Contact MAXON with valve serial numbers to locate appropriate switch kit assembly.

Figure 3: Typical switch sub-assemblies

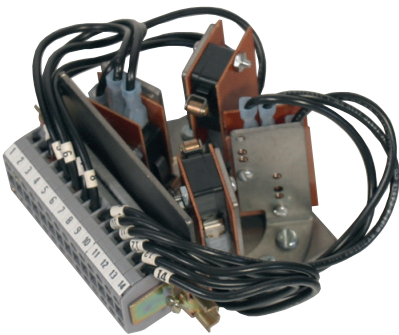

V7 assembly for General Purpose and Intrinsically Safe valves

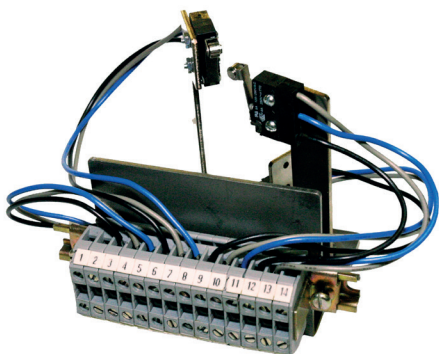

IP67 Switch assembly for Non-Incendive and optional Intrinsically Safe valves

REPLACEMENT SWITCHES

- Carefully remove field wiring from the terminal block (see page 3 (Component identification), item 5). Insure field wires are clearly marked to correct terminal.
- Unwire the solenoid valve lead wires from terminals labeled #1 and #2.
- Remove screws that secure the switch sub-assembly to the actuator housing. The switch sub-assembly should be easily removable from actuator assembly (see Figure 3: Typical Switch Sub-Assemblies).
- Note wand position and mounting hole location. Carefully remove the 2 screws and lift existing switch. Reference Figures 4 through 9 on page 24 (ADD SWITCHES) to ensure correct switch location.
- Install replacement switch in same mounting holes on bracket and verify correct wand position.
- Replace existing wiring one connection at a time, following original route and placement.
- Reassemble switch sub-assembly in actuator housing. Dowel pins are provided to insure proper placement of switch sub-assembly.
- Wire the solenoid valve leads to terminals labeled #1 and #2.
- Cycle valve, checking switch actuation points carefully. VCS switch actuates at top of stem stroke and VOS at bottom for normally-closed shut-off valves; vice-versa for normally-open vent valves.
- Replace covers using torque values on page 4 (Table 1 - Torque Specifications), and then return valve to service.

ADD SWITCHES

- Carefully remove field wiring from the terminal block (see page 3 (Component identification), item 5). Insure field wires are clearly marked to correct terminal.
- Unwire the solenoid valve lead wires from terminals labeled #1 and #2.
- Remove screws that secure the switch sub-assembly to the actuator housing. The switch sub-assembly should be easily removable from actuator assembly (see page 23 (Figure 3: Typical switch sub-assemblies)).
- Reference Figures 4 through 9 (below) to ensure correct switch location. Valve size is depicted in the model number by the first 4 dig- its. For example, a 3" CP valve should have Model No. 300C.
- Install switch and insulators, when provided, to correct hole. Insure proper alignment. VCS switch should have activation wand pointed upward and VOS activation wand should be pointed downward.
- Wire new switches to terminals provided.
- Reassemble switch sub-assembly in actuator housing. Dowel pins are provided to insure proper placement of switch sub-assembly.
- Wire the solenoid valve leads to terminals labeled #1 and #2.
- Cycle valve, checking switch actuation points carefully. VCS switch actuates at top of stem stroke and VOS at bottom for normally- closed shut-off valves; vice-versa for normally-open vent valves.
- Replace covers using torque values on page 4 (Table 1 - Torque Specifications), and then return valve to service.

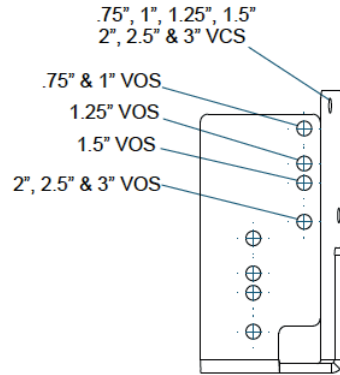

Figure 6:
General Purpose
Switch Bracket

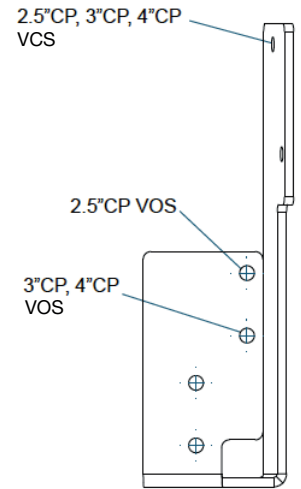

Figure 7:
General Purpose
Switch Assembly

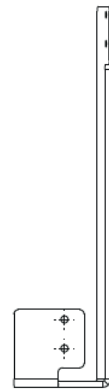

Figure 8:
6" & 8" Valve IP67
Switch Bracket

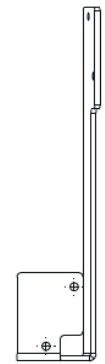

Figure 9:
6" & 8" Valve General
Purpose Switch Bracket

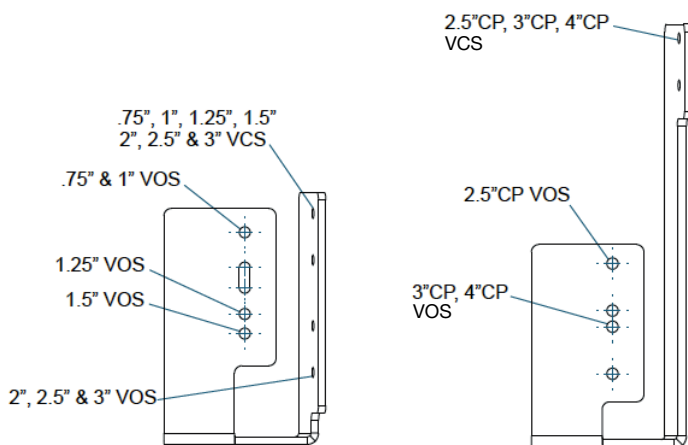

Figure 4:
IP67 Switch Bracket

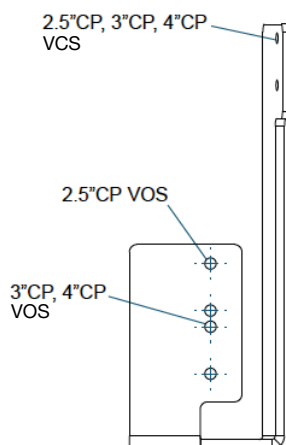

Figure 5:
IP67 Switch Bracket

IEC 61508 INSTRUCTION REQUIREMENTS

PRODUCT DESCRIPTION

A Failure Mode, Effects, and Diagnostics Analysis (FMEDA) report is available from MAXON. Detailed failure rate data is available in the FMEDA reports. Data for Series 8000 Valves with internal solenoids only can be found in Exida Report MAX 08/09-07 R002. Data for Series 8000 Valves with internal solenoid and redundant external solenoid can be found in Exida Report MAX 1208063 R002.

PRIMARY SAFETY FUNCTION

- a. Series 8*1*, Normally Closed will pass flow when energized and shut off flow within the stated leakage specification when de-energized.
- b. Series 8*2*, Normally Open will pass flow when de-energized and shut off flow within the stated leakage specification when energized.
- c. The valves are designed for low demand applications.
- d. The valve must be within specified operating conditions, as found in the instruction manual.

PROOF TEST

The objective of proof testing is to detect failures within the Series 8000 Valve that prevent the valve from performing its safety function.

The frequency of proof testing, or the proof test interval, is to be determined in reliability calculations for the safety instrumented functions for which the Series 8000 Valve is applied. The proof tests must be performed more frequently or as frequently as specified in the calculation in order to maintain the required safety integrity of the safety instrumented function.

Maintenance instructions include a Valve Leak Test. These instructions must be followed during the proof test. This Valve Leak Test will detect approximately 99% of possible DU (Dangerous Undetected) failures resulting in a Proof Test Coverage of 99% for the valve. For specific recommendations on leak test procedures, see MAXON [Valve Technical Document 10-35.2-1](#).

The person(s) performing the proof test of the Series 8000 Valve should be trained in SIS (Safety Instrumented Systems) operations, including bypass procedures, valve maintenance and Company Management of Change procedures.

If implementing partial stroke testing of Series 8000 Valves, see MAXON PSCheck documentation (Form

Number 32M-05004) for diagnostic coverage information related to Series 8000 Valves.

RELIABILITY DATA AND LIFETIME LIMIT

A detailed Failure Mode, Effects, and Diagnostics Analysis (FMEDA) report is available from MAXON. This report details all failure rates and failure modes, common cause factors for applications with redundant devices and the expected lifetime of the Series 8000 Valve.

- a. The Series 8000 Valve is intended for low demand mode applications up to SIL 3 for use in a simplex (1oo1) configuration, depending on the PFDAVG calculation of the entire Safety Instrumented Function.
- b. The development process of the Series 8000 Valve is certified up to SIL 3, allowing redundant use of the valve up to this Safety Integrity Level, depending on the PFDAVG calculation of the entire Safety Instrumented Function.
- c. When using the Series 8000 Valve in a redundant configuration, a common cause factor should be included in reliability calculations. For details, see the FMEDA report.
- d. The reliability data listed in the FMEDA report is only valid for the useful lifetime of the Series 8000 Valve. The failure rates of the Series 8000 Valve may increase sometime after this period. Reliability calculations based on the data listed in the FMEDA report for mission times beyond the lifetime may yield results that are too optimistic, i.e. the calculated Safety Integrity Level will not be achieved.

PRODUCT SAFETY OFFICER

Any failures that are detected and that compromise functional safety should be reported to the Product Safety Officer within MAXON. Please contact MAXON Customer Service.

FITTING CERTIFICATE

We:

MAXON Corporation

Address:

201 E. 18th Street

Muncie, IN 47302

USA

Declare that all fittings produced at the above address
within the following product group:

MAXON Series 8000 Air Actuated Valves

Conform to all applicable provisions of the European Gas
Appliance Regulation.

Certificate number: CE 681603 applies

EC Surveillance: BSI (Notified Body Number 2797)

This certificate issued by: MAXON Corporation

Name: Lora Davis

Title/Position: Product Engineering Manager

Date of issue: September 26, 2019

For More Information

The Honeywell Thermal Solutions family of products includes Honeywell Combustion Safety, Eclipse, Exothermics, Hauck, Kromschröder and Maxon. To learn more about our products, visit ThermalSolutions.honeywell.com or contact your Honeywell Sales Engineer.

Honeywell MAXON branded products

201 E. 18th Street
Muncie, IN 47302
USA
www.maxoncorp.com

Honeywell Process Solutions

Honeywell Thermal Solutions (HTS)
1250 West Sam Houston Parkway
South Houston, TX 77042

ThermalSolutions.honeywell.com

® U.S. Registered Trademark.
© 2022 Honeywell International Inc.
32M-95003-05 Rev. 02-22
EAS 50111985-001
Printed in U.S.A.

The Honeywell logo is displayed in a bold, red, sans-serif font.