

Burners for gas ZIC, ZICW

OPERATING INSTRUCTIONS

· Edition 09.22 · EN · 03250523



1 SAFETY

1.1 Please read and keep in a safe place



Please read through these instructions carefully before installing or operating. Following the installation, pass the instructions on to the operator. This unit must be installed and commissioned in accordance with the regulations and standards in force. These instructions can also be found at www.docuthek.com.

1.2 Explanation of symbols

1, 2, 3, a, b, c = Action

→ = Instruction

1.3 Liability

We will not be held liable for damage resulting from non-observance of the instructions and non-compliant use.

1.4 Safety instructions

Information that is relevant for safety is indicated in the instructions as follows:

⚠ DANGER

Indicates potentially fatal situations.

⚠ WARNING

Indicates possible danger to life and limb.

⚠ CAUTION

Indicates possible material damage.

All interventions may only be carried out by qualified gas technicians. Electrical interventions may only be carried out by qualified electricians.

1.5 Conversion, spare parts

All technical changes are prohibited. Only use OEM spare parts.

CONTENTS

1 Safety	1
2 Checking the usage	2
3 Installation	3
4 Wiring	5
5 Preparing commissioning	6
6 Commissioning	8
7 Maintenance	9
8 Assistance in the event of malfunction	11
9 Accessories	12
10 Technical data	12
11 Logistics	13
12 Disposal	13
13 Declaration of Incorporation	14
14 Certification	14

2 CHECKING THE USAGE

Burner for heating industrial thermoprocessing equipment. Burners BIC or BICA can be used in conjunction with the ceramic tube set TSC in industrial furnaces or firing systems with brick lining or ceramic fibre lining. No burner block is necessary. For natural gas, town gas and LPG. Other types of gas on request. This function is only guaranteed when used within the specified limits – see also page 12 (10 Technical data). Any other use is considered as non-compliant.

2.1 Type label

Construction stage, rated capacity Q_{max} , gas type – see type label.

  	
ZIC 165HB-0/35-(18)F	
84246518	Ø mm
P 630; 550 kW	.3322

2.2 Type code

ZIC	Burner for gas, with connection for ceramic tube
ZICW	Burner for gas, with ceramic fibre insulation (RCF)
165-200	Burner size
R	Cold air
H	Hot air/high furnace temperature
B	Natural gas
D	Coke oven gas, town gas
G	Propane, propane/butane, butane
M	Propane, propane/butane, butane (with mixer)
L	Low calorific value gas
L	Torch
R	Reduced capacity
-X	X mm length of steel tube as of furnace flange (L1)
/X	X mm distance from furnace flange to front edge of burner head (L2)
-(X)	Burner head identifier
-(XE)	Heat-resistant version
A-Z	Construction stage
H	High temperature version

2.3 Part designations

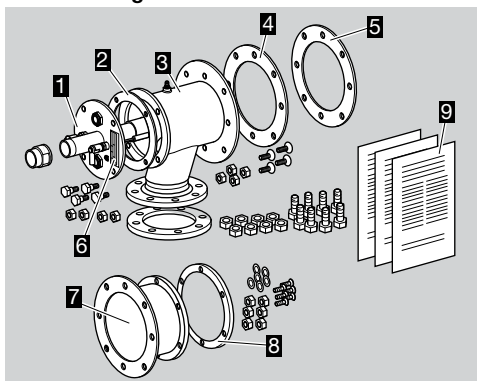

- 1 Burner insert
- 2 Gas housing gasket
- 3 Air housing
- 4 Mounting flange
- 5 Mounting gasket
- 6 Type label
- 7 Burner extension (for ZIC...-100, ZIC...-200)
- 8 Clamping ring
- 9 Operating instructions – for more documents and calculation tools, see www.adlatus.org

2.4 Burner head

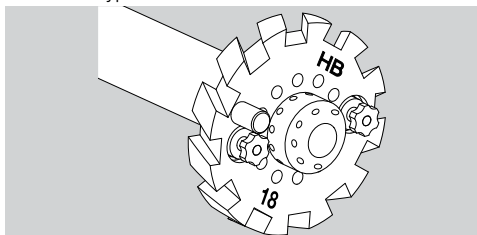

→ Check letter marking and identification marks on the burner head using the information provided on the type label.



2.5 Ceramic tube

Type label

Length and diameter – see type label.

 	
TSC 200A180-300/35-	
74924401	SI-1500

2.6 Type code

TSC	Ceramic tube set
165-200	Burner size
A	Cylindrical shape
B	Tapered shape
154, 180	Outlet diameter [mm]
200-300	Length [mm]
/35-,	Distance from furnace flange to front edge of burner baffle plate [mm]
Si	Silicon-infiltrated SiC
1500	Up to 1500°C

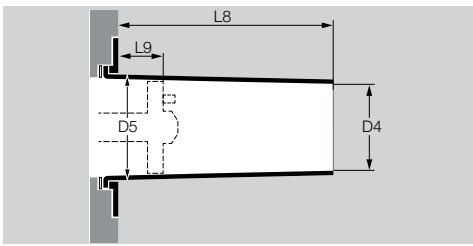

2.7 Part designations

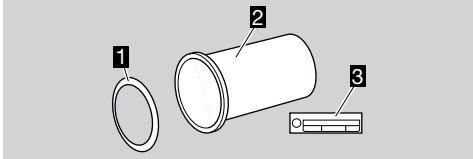

- 1 Burner tube gasket
- 2 Ceramic tube
- 3 Type label

3 INSTALLATION

3.1 Installing the ceramic tube

⚠ WARNING

- Install the ceramic tube centrally and free of mechanical stress to avoid damage. Remove and dispose of the transport safety device; to do this, remove the mounting flange or clamping ring.

→ Remove the burner insert in order to install the ceramic tube. For this purpose, the air housing can be placed in a vertical position on a smooth working surface.

→ On ZICW, avoid the formation of dust when dismantling the burner insert and do not damage the surface of the internal insulation.

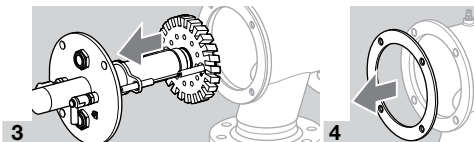
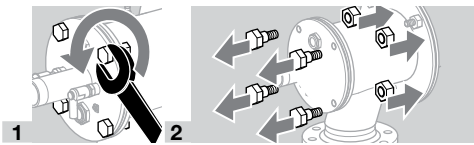

5 Place the burner insert in such a way that the insulators are protected against damage.

No burner extension

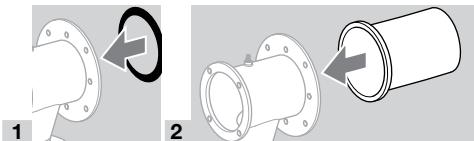

→ Install the ceramic tube centrally and free of mechanical stress.

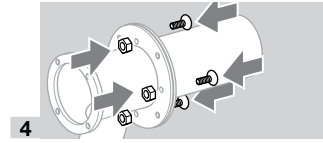
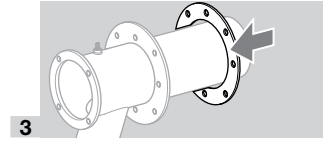

→ Centre the ceramic tube.

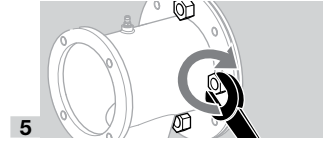

- Tighten the screws in a crosswise fashion.
- Mounting flange and furnace flange must be flush.

With burner extension

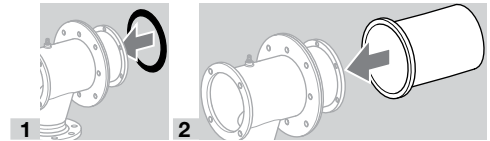

→ Centre the ceramic tube.

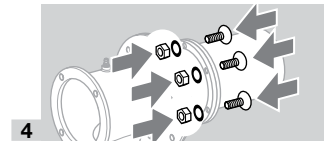
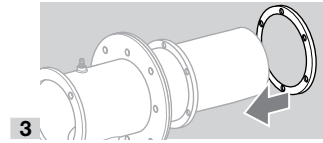

→ Insert lock washer pairs.

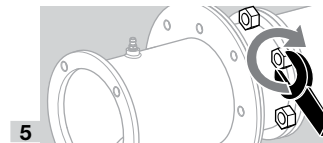

→ Tighten the screws in a crosswise fashion.

3.2 Insulating the ceramic tube

- Protect the burner extension from thermal stress.
- We recommend solid shaped parts A or high temperature resistant ceramic fibrous material B for insulation.
- Observe an annular void of at least 10 mm (0.4 inches).
- Insulate the ceramic tube at least as far as the burner head, to a maximum of 20 mm (0.8 inches) behind the burner head.
- Burners without extension:

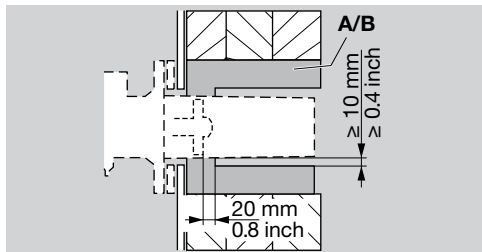

- Burners with extension:

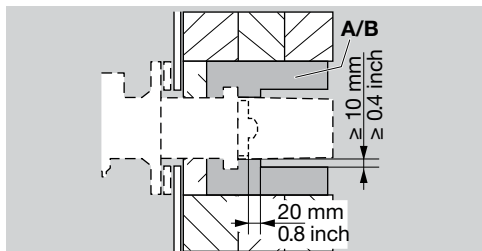

3.3 Installation on the furnace

- When installing, always ensure that when the burner is mounted, it is sealed tightly on the furnace wall.

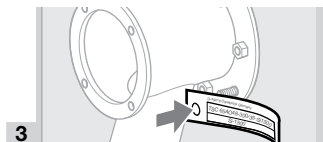
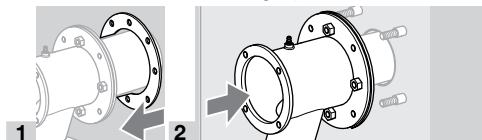

- Attach the ceramic tube type label.

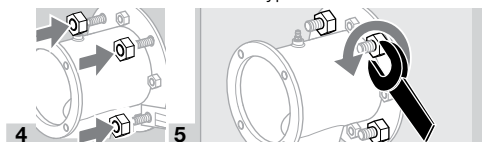

3.4 Air connection, gas connection

ZIC

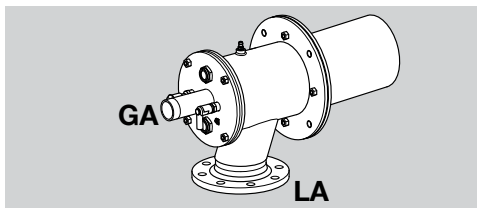

ZICW

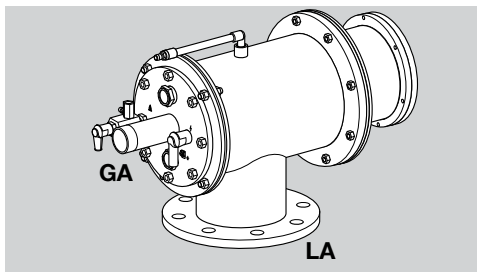

Type	Gas connection GA	Air connection LA
ZIC 165	Rp 1 1/2	DN 100
ZIC 200	Rp 2	DN 150
ZICW 165	Rp 1 1/2	DN 150
ZICW 200	Rp 2	DN 200

- Threaded connection to DIN 2999, flange dimensions to DIN 2633, PN 16.
- Install flexible tubes or bellows units to prevent mechanical stress or transmission of vibration.
- Ensure that the gaskets are undamaged.

⚠ DANGER

Risk of explosion!

- Ensure the connection is air-tight.

3.5 Connection to ANSI/NPT

- An adapter set is required for connection to ANSI/NPT, see page 12 (9.2 Adapter set).

Type	Gas connection GA	Air connection LA*
ZIC 165	2-11.5 NPT	4.57"
ZIC 200	2-11.5 NPT	6.72"
ZICW 165	1 1/2 NPT-11,5 NPT	6.72"
ZICW 200	2 NPT-11,5 NPT	8.71"

Flange hole diameter.

- Weld flange **J** to air pipe **P** for air connection **LA** and use NPT thread adapter **H** for gas connection **GA**.

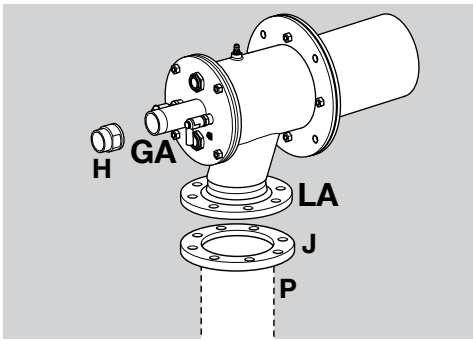

→ The nozzle set with NPT thread is required for integrated pilots, see page 12 (9.3 Nozzle set).

3.6 Pilot connections on the ZIC..L

- Air connection la.
- Gas connection ga.
- Pilot capacity: 1.5 kW.

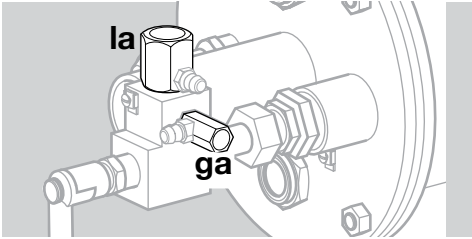

Type	Pilot gas connection ga	Pilot air connection la
ZIC..L	Rp 1/4	Rp 1/2
ZIC..L with adapter set	1/4" NPT	1/2" NPT

3.7 Installing the burner insert

⚠ WARNING

- **ZICW:** do not damage the surface of the insulation. Avoid the formation of dust.
- The burner insert can be rotated to the required position in increments of 90°.
- 1** Insert the gas housing gasket between the burner insert and the air housing.

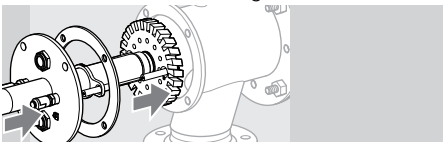

- 2** Tighten the burner insert in a crosswise fashion with max. 37 Nm (27.3 lbf ft):



4 WIRING

⚠ DANGER

Electric shocks can be fatal!

- Before working on possible live components, ensure the unit is disconnected from the power supply.
- For the ignition and ionization cables, use (un-screened) high-voltage cable:
 - FZLSi 1/6 up to 180°C (356°F), Order No. 04250410, or
 - FZLK 1/7 up to 80°C (176°F), Order No. 04250409.

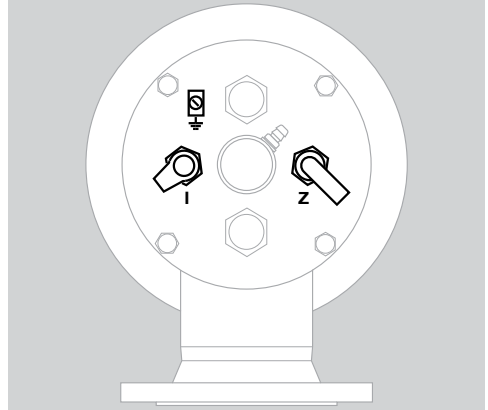

Flame rod I

- Install the ionization cable well away from mains cables and interference from electromagnetic sources and avoid external electrical interference. Max. length of ionization cable – see automatic burner control unit operating instructions.
- Connect the flame rod to the automatic burner control unit via the ionization cable.

Spark electrode Z

- Length of ignition cable: max. 5 m (15 ft), recommended < 1 m (40").
- For permanent ignition, max. ignition cable length 1 m (40").
- Lay the ignition cable individually and not in a metal conduit.
- Install the ignition cable separately from ionization and UV cables.
- A ≥ 7.5 kV, ≥ 12 mA ignition transformer is recommended; 5 kV for integrated pilot.

Flame rod and spark electrode

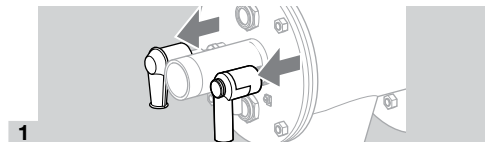

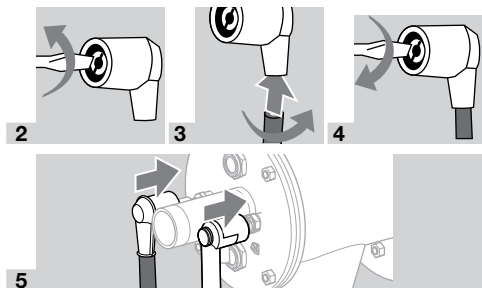

6 Connect the PE wire for burner ground to the burner insert. In the case of single-electrode operation, route the PE wire from the burner insert directly to the terminal on the automatic burner control unit.

⚠ WARNING

High-voltage risk!

– It is essential that a high-voltage warning label be attached to the ignition cable.

7 For more detailed information on how to wire the ionization and ignition cables, refer to the operating instructions and connection diagrams of the automatic burner control unit and ignition transformer.

5 PREPARING COMMISSIONING

5.1 Safety instructions

- Agree on settings and commissioning of the burner with the system operator or manufacturer.
- Check the entire system, upstream devices and electrical connections.
- Note the operating instructions for individual controls.

⚠ DANGER

Risk of explosion!

- Please observe the appropriate precautions when igniting the burner.
- Pre-purge the furnace chamber or radiant tube with air (5 x volume) before every ignition attempt.
- Fill the gas line to the burner carefully and correctly with gas and vent it safely into the open air – do not discharge the test volume into the furnace chamber.

⚠ DANGER

Risk of poisoning!

- Open the gas and air supply so that the burner is always operated with excess air – otherwise CO will form in the furnace chamber. CO is odourless and poisonous! Conduct a flue gas analysis.
 - The burner must only be commissioned by authorized trained personnel.
- If the burner does not ignite even though the automatic burner control unit has been switched on and off several times: check the entire system.

→ After ignition, monitor the flame and the gas and air pressure measured on the burner. Measure the ionization current. Switch-off threshold – see automatic burner control unit operating instructions.

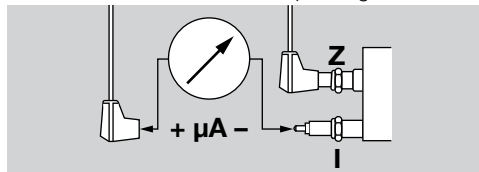

→ The burner must only be ignited at low-fire rate (between 10 and 30% of the rated capacity Q_{max}) – see type label.

5.2 Determining the gas and combustion air flow rates

$$Q_{Gas} = P_B / H_i$$

$$Q_{Luft} = Q_{Gas} \cdot \lambda \cdot L_{min}$$

- Q_{gas} : Gas flow rate in m^3/h (ft^3/h)
 - P_B : Burner capacity in kW (BTU/h)
 - H_i : Gas heating value in kWh/m^3 (BTU/ ft^3)
 - Q_{air} : Air flow rate in $m^3(n)/h$ (SCFH)
 - λ : Lambda, air index
 - L_{min} : Minimum air requirement in $m^3(n)/m^3(n)$ (SCF/SCF)
- Information on the gas quality supplied can be obtained from the gas supply company.

Common gas qualities

Gas type	Heating value		
	H_u	H_o	L_{min}
	kWh/ $m^3(n)$	BTU/ SCF	$m^3(n)/$ $m^3(n)$ (SCF/ SCF)
Natural gas H	11.0	1114	10.6
Natural gas L	8.9	901	8.6
Propane	25.9	2568	24.4
Low calorific value gas	1.7–3	161–290	1.3–2.5
Butane	34.4	3406	32.3

- Data in $kWh/m^3(n)$ refer to the lower heating value H_u and data in BTU/SCF refer to the higher heating value H_o (gross calorific value).
- A minimum air excess of 20% ($\lambda = 1.2$) should be set in a cold furnace for initial adjustment since the air volume falls as the temperature rises.
- Fine adjustment should be carried out at max. furnace temperature and at as high a capacity demand as possible.

5.3 Notes on the flow rate curve

→ If the gas density in the operating state differs from that reflected in the flow rate curve, convert the pressures according to the local operating state.

$$P_B = P_M \cdot \frac{\delta_B}{\delta_M}$$

- δ_{M_i} : Gas density reflected in the flow rate curve in kg/m³ (lb/ft³)
- δ_B : Gas density in operating state in kg/m³ (lb/ft³)
- p_{M_i} : Gas pressure reflected in the flow rate curve
- p_B : Gas pressure in operating state

1 Read the gas pressure p_{gas} and air pressure p_{air} from the enclosed flow rate curve for cold air on the basis of the calculated flow rates Q .

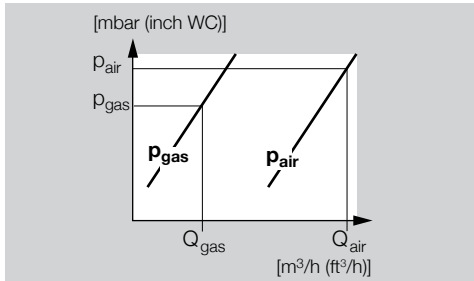

- Note possible capacity changes due to positive or negative pressures in the furnace/combustion chamber. Add positive pressures or subtract negative pressures.
- As not all the effects caused by the equipment are known, setting the burner using the pressure values is only approximate. It is possible to set the burner precisely by measuring the flow rates or flue gas.

5.4 Restrictors

- The air volume required for the low-fire rate at a given air pressure is determined by the ignition position of a butterfly valve, a bypass hole in the air valve or an external bypass with restrictor.

5.5 Hot air compensation

- The combustion air pressure p_{air} must be increased in hot air operating mode ($\lambda = \text{constant}$).

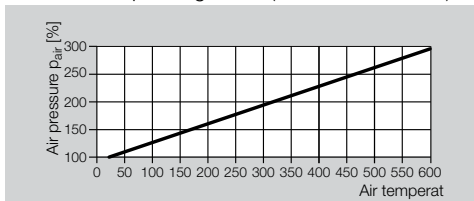

- The gas pressure is increased by 5–10 mbar.
- The total burner capacity P_{gas} rises as the air temperature increases.

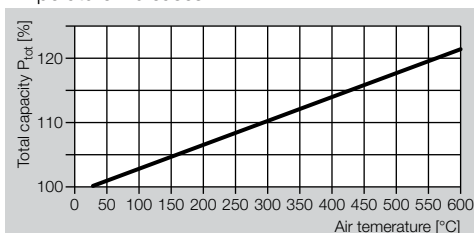

5.6 Burners with electrodes with air connection

- Burner head marking (...D) or (...E)

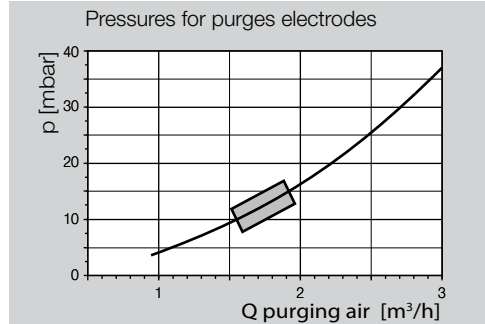
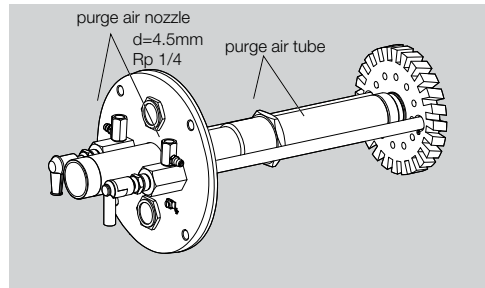

- A purge air volume of approx. 1.5 to 2 m³/h per electrode is recommended.
- The purge air may not be switched off until the furnace is cold and formation of condensation is no longer possible.

5.7 Setting the air pressure for low fire and high fire

- 1** Shut off the gas and air supply.
- Air measuring nipple **L**, outside dia. = 9 mm (0.35").

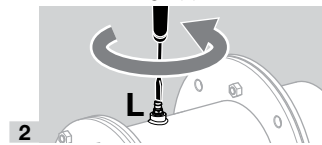

- 2**
- Loosen the screw 2 turns.

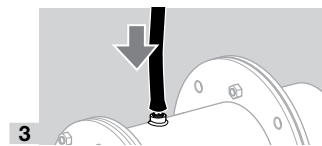

- 3**
- 4** Fully open the air supply.

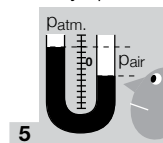

- 5**
- p_{atm} = atmospheric pressure.

Low-fire rate

- The burner must only be ignited at low-fire rate (between 10 and 40% of the rated capacity Q_{max} – see page 2 (2.1 Type label)).

6 Reduce the air supply on the air control valve and set the desired low-fire rate, e.g. using a limit switch or mechanical stop.

→ On air control valves with bypass, the bypass orifice should be determined on the basis of the required flow rate and the existing supply pressure if required.

High-fire rate

7 Set the air control valve to high-fire rate.

8 Set the required air pressure p_{air} on the air restrictor upstream of the burner.

9 When using air restricting orifices: check the air pressure p_{air} .

5.8 Preparing the gas pressure measurement for low fire and high fire

1 Connect all measuring devices for subsequent fine adjustment of the burner.

→ Leave the gas supply closed.

→ Gas measuring nipple **G**, outside dia. = 9 mm (0.35").

1 Read the gas pressure p_{gas} for the required flow rate Q from the enclosed flow rate curve for cold air

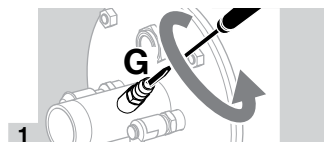
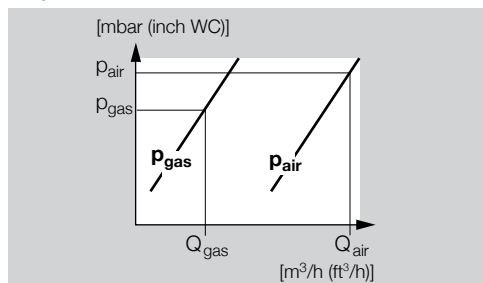

→ Loosen the screw 2 turns.

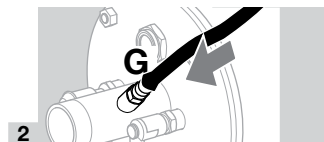

5.9 Integrated pilot on the ZIC..L

→ Air pressure test nipple **I**, outside dia. = 9 mm (0.35").

Gas pressure test nipple **g**, outside dia. = 9 mm (0.35").

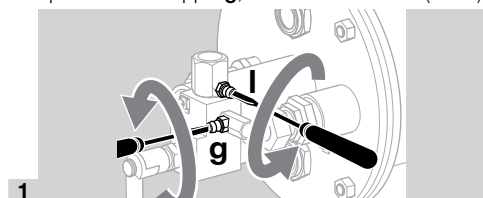

→ Loosen the screws 2 turns.

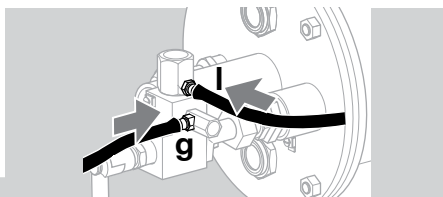

→ Pilot:

$p_{\text{gas}} = 30\text{--}50$ mbar,

$p_{\text{air}} = 30\text{--}50$ mbar.

→ Check flame stability and ionization current.

→ The gas and air pressure of the integrated pilot must be higher than the gas and air pressure of the main burner.

6 COMMISSIONING

6.1 Igniting and adjusting the burner

⚠ WARNING

– Ensure adequate ventilation of the furnace chamber before each burner start!

→ The burner body will become hot during operation with preheated combustion air. Provide protection against accidental contact as required.

1 All valves of the installation must be checked for tightness before ignition.

6.2 Setting the low-fire rate

1 Set the valves to ignition position.

2 Limit the maximum gas volume.

→ Should an adjustable gas restrictor be installed upstream of the burner, open the restrictor by approx. a quarter.

3 Open the gas supply.

4 Ignite the burner.

→ The safety time of the automatic burner control unit starts to elapse.

5 If no flame forms, check and adjust the gas and air pressures of the start gas adjustment.

6 In the case of operation with bypass (e.g. when using an air/gas ratio control): check the bypass nozzle and adjust if required.

7 In the case of operation without bypass (e.g. when using an air/gas ratio control without bypass): increase the low-fire rate setting.

8 Check the basic setting or bypass of the air control valve.

9 Check the position of the restrictor in the air line.

10 Check the fan.

11 Reset the automatic burner control unit and re-ignite the burner.

→ The burner ignites and proceeds to normal operation.

12 Check flame stability and ionization current at low-fire rate. Switch-off threshold – see automatic burner control unit operating instructions.

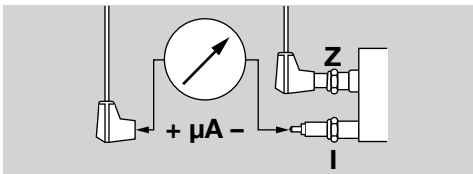

- 13 Monitor flame formation.
- 14 Adjust the low-fire rate settings if required.
- 15 If no flame is detected – see page 11 (8 Assistance in the event of malfunction).

6.3 Setting the high-fire rate

- 1 Set the air and gas circuit of the burner to high fire while continuously monitoring the flame.
- Avoid CO formation – always operate the burner with excess air when starting up!
- When the desired maximum valve positions are reached, set the gas pressure p_{gas} using the restrictor upstream of the burner.

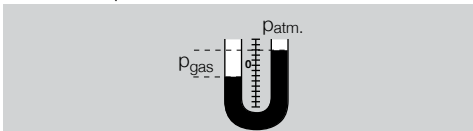

6.4 Readjusting the air flow rate

- 1 Check the air pressure p_{air} on the burner and adjust using the air restrictor if required.
- 2 When using air restricting orifices: check the air pressure p_{air} and rework the orifice if required.

⚠ DANGER

Risk of explosion and poisoning in case of burner adjustment with insufficient air!

- Adjust the gas and air supply so that the burner is always operated with excess air – otherwise CO will form in the furnace chamber. CO is odourless and poisonous! Conduct a flue gas analysis.
- 3 Measure the gas and air flow rates if possible. Determine the lambda value and readjust the settings if required.

6.5 Tightness test

⚠ DANGER

Escaping gas!

Danger from a leakage at the gas connections.

- Check the gas connections on the burner for leaks immediately after commissioning the burner.

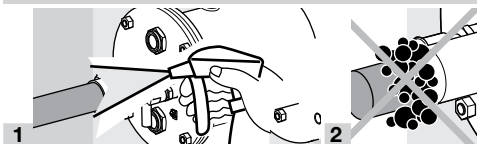

- Avoid condensation due to the furnace atmosphere entering the burner body. While the burner is switched off, at furnace temperatures above

500°C (932°F), it must be cooled with a low air volume – see page 9 (6.6 Cooling air).

6.6 Cooling air

- While the burner is switched off and depending on the furnace temperature, there must be a certain air flow for cooling the burner components.

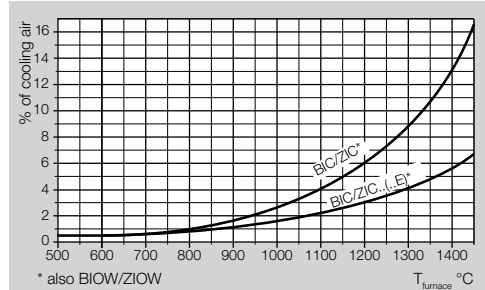

- Diagram: the cooling air percentage specified in the diagram refers to the operating flow rate for air.
- Leave the air fan switched on until the furnace has cooled down completely.

6.7 Blocking and recording the settings

- 1 Produce a measurement report.
- 2 Set the burner to low fire and check the settings.
- 3 Set the burner to low and high fire several times while monitoring the pressure settings, flue gas values and flame patterns.
- 4 Remove the measuring devices and close off the test nipples – tighten the grub screws.
- 5 Block and seal the adjusting elements.
- 6 Induce a flame failure, e.g. by pulling the terminal boot off the flame rod. The flame detector must close the gas safety valve and signal a fault.
- 7 Switch the system on and off several times while monitoring the automatic burner control unit.
- 8 Produce an acceptance report.

⚠ DANGER

Risk of explosion in case of CO being formed in the furnace chamber! CO is odourless and poisonous!

An incorrect change of the burner settings may change the gas/air ratio and lead to unsafe operating conditions:

- All interventions may only be carried out by qualified gas technicians.

7 MAINTENANCE

- Maintenance and function check every six months. If the media are highly contaminated, this interval should be reduced.

⚠ DANGER

Risk of explosion!

- Please observe the appropriate precautions when igniting the burner.

- Maintenance work on the burner must be carried out by authorized trained personnel only.

⚠ DANGER

Risk of burning!

- Outflowing flue gases and burner components are hot.

→ We recommend that all the gaskets removed during maintenance work be replaced. The appropriate gasket set is available separately as a spare part.

1 Check the ionization and ignition cables.

2 Measure the ionization current.

→ The ionization current must be at least 5 μA and must not vary.

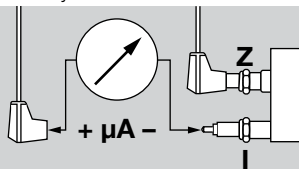

3 Disconnect the system from the electrical power supply.

4 Shut off the gas and air supply – do not change the restrictor settings.

7.1 Checking the spark electrode and flame rod

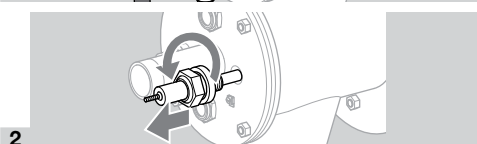
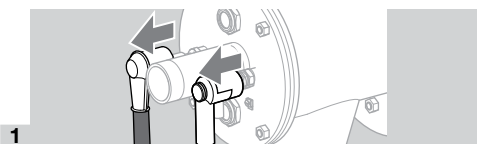

→ Ensure that the electrode length does not change.

3 Remove dirt from electrodes or insulators.

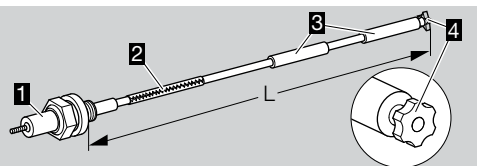

4 If the star **4** or insulator **3** is damaged, replace the electrode.

→ Before changing the electrode, measure the total length **L**.

5 Connect the new electrode with the spark plug **1** using the dowel pin **2**.

6 Adjust spark plug and electrode to the measured total length **L**.

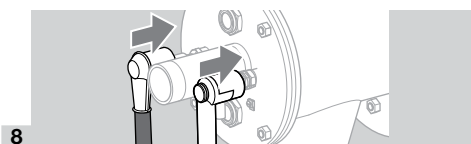
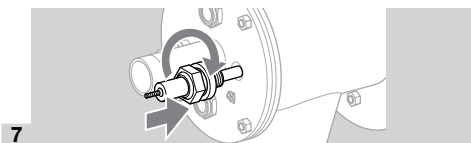

→ Turning the spark plug makes it easier to feed the electrode into the burner insert.

7.2 Checking the burner

Removing and installing burner insert ZICW

→ Do not damage the surface of the insulation.

→ Avoid the formation of dust.

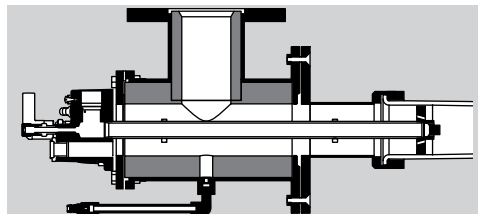

ZIC and ZICW

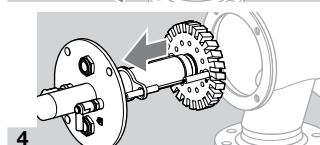
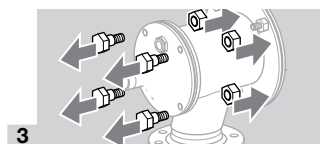
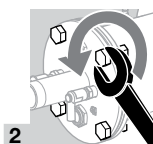

→ If the burner insert is dismantled, the gas housing gasket will have to be renewed.

5 Place the burner insert in a safe place.

→ Depending on the amount of dirt or wear: replace the spark electrode/flame rod and dowel pin during servicing – see page 10 (7.1 Checking the spark electrode and flame rod).

6 Check burner head for dirt and thermal cracks.

⚠ WARNING

Risk of injury!

- Burner heads have sharp edges.

→ When replacing any burner components: apply ceramic paste to the screw connections in order

to avoid cold-setting – see page 12 (9.1 Ceramic paste).

7 Check the electrode positions.

→ The insulator must be flush with the front edge of the burner air disc.

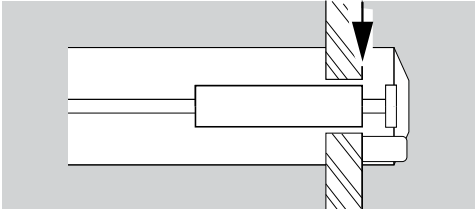

→ Distance of spark electrode from ground pin or gas nozzle: $2 \pm 0.5 \text{ mm}$ (0.08 ± 0.02 ").

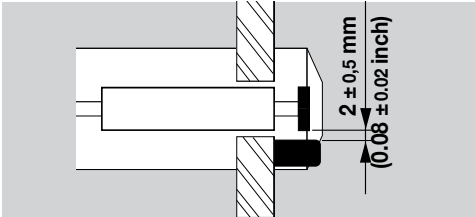

8 When the furnace chamber has cooled down, check the burner tube and burner block through the furnace flange.

→ Replace the gas housing gasket.

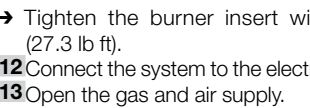
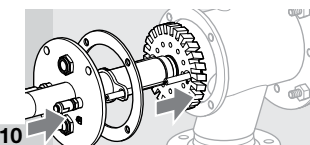
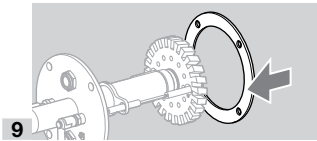

→ Tighten the burner insert with max. 37 Nm (27.3 lb ft).

12 Connect the system to the electrical power supply.

13 Open the gas and air supply.

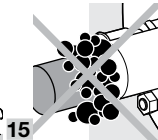
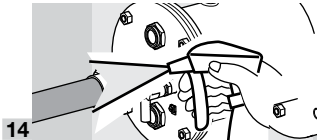

16 Set the burner to low fire and compare the pressure settings to those stated in the acceptance report.

17 Set the burner to low and high fire several times while monitoring the pressure settings, flue gas values and flame patterns.

⚠ DANGER

Risk of poisoning!

– Open the gas and air supply so that the burner is always operated with excess air – otherwise

CO will form in the combustion chamber. CO is odourless and poisonous! A flue gas analysis should be conducted.

⚠ DANGER

Risk of explosion and poisoning in case of burner adjustment with insufficient air!

– Adjust the gas and air supply so that the burner is always operated with excess air – otherwise CO will form in the furnace chamber. CO is odourless and poisonous! Conduct a flue gas analysis.

18 Produce a maintenance report.

8 ASSISTANCE IN THE EVENT OF MALFUNCTION

⚠ DANGER

Electric shocks can be fatal!

– Before working on possible live components, ensure the unit is disconnected from the power supply.

⚠ DANGER

Risk of injury!

Burner heads have sharp edges.

– Burner inspection must only be performed by authorized trained personnel.

→ If no issues are found when checking the burner, proceed to the automatic burner control unit and check for faults in accordance with the relevant operating instructions.

? Fault

! Cause

• Remedy

? Burner does not function.

! Valves do not open.

• Check the voltage supply and wiring.

! Tightness control signals a fault.

• Check the valves for tightness.

• Note the tightness control operating instructions.

! Control valves do not move to low-fire rate position.

• Check the impulse lines.

! Gas inlet pressure is too low.

• Check the filter for dirt.

• Check the gas supply.

! Air inlet pressure is too low.

• Check the fan and air supply.

! Gas and air pressures on the burner are too low.

• Check the restrictors.

• Check/adjust the start rate setting, see operating instructions for solenoid valve.

! Automatic burner control unit does not function correctly.

- Check the device fuse.
- Note the automatic burner control unit operating instructions.

- ! Automatic burner control unit signals a fault.
- Check the ionization cable.
 - Check the ionization current. The ionization current must be at least 5 μ A – stable signal.
 - Check whether the burner is adequately grounded.
 - Note the automatic burner control unit operating instructions.

- ! No ignition spark is created.
- Check the ignition cable.
 - Check the voltage supply and wiring.
 - Check whether the burner is adequately grounded.
 - Check the electrode – see page 9 (7 Maintenance).

- ! Defective insulator on the electrode, ignition spark jumps over incorrectly.
- Check the electrode.

? **Burner performs a fault lock-out after operating faultlessly in normal operation.**

- ! Incorrect gas and air flow rate settings.
- Check the differential pressures for gas and air.

- ! Automatic burner control unit signals a fault.
- Check the ionization cable.
 - Check the ionization current. The ionization current must be at least 5 μ A – stable signal.

- ! Burner head is dirty.
- Clean gas and air bore holes and air slots.
 - Remove deposits.

- ! Excessive pressure fluctuations in the combustion chamber.
- Ask Honeywell Kromschroder for control concepts.

9 ACCESSORIES

9.1 Ceramic paste

For avoiding cold-setting on screw connections after replacing burner components. Order No.: 050120009.

9.2 Adapter set

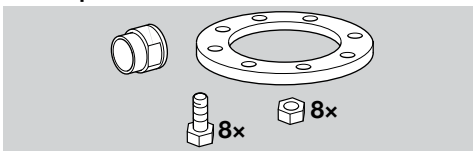

For connecting ZIC to NPT/ANSI connections.

Burner	Adapter set	Order No.
ZIC 165	BR 165 NPT	74922636
ZIC 200	BR 200 NPT	74922637

Adapted set for ZICW on request.

9.3 Nozzle set

→ Available on request for connecting integrated pilots to NPT threads.

10 TECHNICAL DATA

Gas supply pressure and air supply pressure each depend on the use and gas type.

Gas and air pressures:

see burner diagrams at www.docuthek.com. Special gaskets are available on request for air pressures of > 100 mbar (39.4 °WC) (e.g. reverse flow pressure in the furnace).

Burner flow rate curves:

A web app to view the burner flow rate curves is available at www.adlatus.org.

Gas types:

natural gas, LPG (gaseous), coke oven gas, town gas and low calorific value gas; other gases on request.

Combustion air:

The air must be dry and clean in all temperature conditions and must not contain condensate.

Overall lengths:

100 to 500 mm (3.9 to 19.7 inches) or 50 to 450 mm (2 to 17.7 inches), length increments: 100 mm (3.94 inches) (other lengths available on request).

Control type:

staged: On/Off,
modulating: constant λ value.

Flame control:

with flame rod (UV control as an option).

Ignition:

direct spark ignition; integrated pilot as an option. Storage temperature: -20°C to +40°C.

Burner body:

ZIC: St,
ZICW: St + internal insulation.

Most of the burner components are made of corrosion-resistant stainless steel.

Ambient conditions:

-20°C to +180°C (68°F to 356°F) (outside the thermoprocessing system); no condensation permitted, painted surfaces may corrode.

Maximum furnace temperature: 1450°C (2642°F)

Maximum air temperature:

ZIC: up to 450°C (842°F),

ZICW: up to 600°C (1112°F).

10.1 Ceramic tube

Material: SI-1500.

Maximum furnace temperature: up to 1450°C (2642°F).

Maximum air temperature: up to 600°C (1112°F).

Maximum material temperature: up to 1500°C (2732°F).

10.2 REACH Regulation

applies to ZICW only.

Information pursuant to REACH Regulation No. 1907/2006, Article 33.

Insulation contains refractory ceramic fibres (RCF)/aluminium silicate wool (ASW).

RCF/ASW are listed in the Candidate List of the European REACH Regulation No. 1907/2006.

11 LOGISTICS

Transport

Protect the unit from external forces (blows, shocks, vibration).

Transport temperature: see page 12 (10 Technical data).

Transport is subject to the ambient conditions described.

Report any transport damage on the unit or packaging without delay.

Check that the delivery is complete.

Storage

Storage temperature: see page 12 (10 Technical data).

Storage is subject to the ambient conditions described.

Storage time: 6 months in the original packaging before using for the first time. If stored for longer than this, the overall service life will be reduced by the corresponding amount of extra storage time.

12 DISPOSAL

Devices with electronic components:

WEEE Directive 2012/19/EU – Waste Electrical and Electronic Equipment Directive



At the end of the product life (number of operating cycles reached), dispose of the packaging and product in a corresponding recycling centre. Do not dispose of the unit with the usual domestic refuse. Do not burn the product. On request, old units may be returned carriage paid to the manufacturer in accordance with the relevant waste legislation requirements.

13 DECLARATION OF INCORPORATION

Honeywell

according to 2006/42/EC, Annex II, No. 1B
The product ZIC/ZICW is a partly completed machine pursuant to Article 2g and is designed exclusively for installation in or assembly with another machine or other equipment.

The following essential health and safety requirements in accordance with Annex I of this Directive are applicable and have been fulfilled:
Annex I, Articles 1.1.3, 1.1.5, 1.3.2, 1.3.4., 1.5.2, 1.7.4, 1.5.10.

The relevant technical documentation has been compiled in accordance with part B of Annex VII and will be sent to the relevant national authorities on request as a digital file.
The following (harmonized) standards have been applied:

- EN 746-2:2010 – Industrial thermoprocessing equipment; Safety requirements for combustion and fuel handling systems
- EN ISO 12100:2010 – Safety of machinery – General principles for design – Risk assessment and risk reduction (ISO 12100:2010)

The following EU Directives are fulfilled:
RoHS II (2011/65/EU)

The partly completed machine may only be commissioned once it has been established that the machine into which the product mentioned above is to be incorporated complies with the provisions of the Machinery Directive 2006/42/EC.
Elster GmbH

Einbauerklärung / **Declaration of Incorporation**
nach 2006/42/EG, Anhang II, Nr. 1B / according to 2006/42/EC, Annex II No. 1B

Folgendes Produkt / The following product:

Bezeichnung:
Description
Typenbezeichnung / Type:
Markenname / Branding:

Brenner für Gas
Burner for gas
B90, B90A, Z10, BIC, B9CA, Z1C
B10W, Z10W, B9CW, Z1CW

krom/schroder

ist eine unvollständige Maschine nach Artikel 2g und ausschließlich zum Einbau in oder zum Zusammenbau mit einer anderen Maschine oder Ausrüstung vorgesehen.
is a partly completed machine pursuant to Article 2g and is designed exclusively for installation in or assembly with another machine or other equipment.

Folgende grundlegende Sicherheits- und Gesundheitsschutzanforderungen gemäß Anhang I dieser Richtlinie können zur Anwendung und wurden eingehalten:
The following essential health and safety requirements in accordance with Annex I of this Directive are applicable and have been fulfilled:

Anhang I, Artikel / Annex I, Article
1.1.3, 1.1.5, 1.3.2, 1.3.4, 1.5.2, 1.7.4, 1.5.10

Die speziellen technischen Unterlagen gemäß Anhang VII B wurden erstellt und werden der zuständigen nationalen Behörde auf Verlangen in elektronischer Form übermittelt.
The relevant technical documentation has been compiled in accordance with part B of Annex VII and will be sent to the relevant national authorities on request as a digital file.

Folgende (harmonisierte) Normen wurden angewandt: / The following (harmonized) standards have been applied:
EN 746-2:2010 – Industrielle Thermoprocessinganlagen; Sicherheitsanforderungen an Feuerungen und Brennstoffhandlungssysteme
= Industrial thermoprocessing equipment; Safety requirements for combustion and fuel handling systems
EN ISO 12100:2010 – Sicherheit von Maschinen – Allgemeine Gestaltungsgrundsätze – Risikoanalyse und Risikoreduzierung (ISO 12100:2010)
= Safety of machinery – General principles for design – Risk assessment and risk reduction (ISO 12100:2010)

Folgende EU-Richtlinien wurden erfüllt: / The following EU directives are fulfilled:

RoHS II (2011/65/EU)

Die unvollständige Maschine darf erst dann in Betrieb genommen werden, wenn festgestellt wurde, dass die Maschine, in der das oben bezeichnete Produkt eingebaut werden soll, den Bestimmungen der Richtlinie für Maschinen (2006/42/EC) entspricht.
The partly completed machine may only be commissioned once it has been established that the machine into which the product mentioned above is to be incorporated complies with the provisions of the Machinery Directive 2006/42/EC.

Lotte (Böden)
Datum / Date

M. Rieken, S. Escher
M. Rieken, S. Escher
Konstrukteur / Designer

M. Rieken, S. Escher sind bevollmächtigt, die speziellen technischen Unterlagen gemäß Anhang VII B zusammenzustellen.
M. Rieken, S. Escher are authorized to compile the relevant technical documentation according to Annex VII B.

Elster GmbH

Postfach 38 09

D-49504 Strothweg 1

49504 Lotte (Böden)

TL: +49 (0)541 12 14-0

Fax: +49 (0)541 12 14-70

mailto:hs@elster.com

www.elster.com

14 CERTIFICATION

14.1 Eurasian Customs Union



The products ZIC meet the technical specifications of the Eurasian Customs Union.

14.2 China RoHS

Directive on the restriction of the use of hazardous substances (RoHS) in China. Scan of the Disclosure Table China RoHS2, see certificates at www.docuthek.com.

FOR MORE INFORMATION

The Honeywell Thermal Solutions family of products includes Honeywell Combustion Safety, Eclipse, Exothermics, Hauck, Kromschroder and Maxon. To learn more about our products, visit ThermalSolutions.honeywell.com or contact your Honeywell Sales Engineer.
Elster GmbH
Strothweg 1, D-49504 Lotte
T +49 541 1214-0
hsts.lotte@honeywell.com
www.kromschroeder.com

Global centralized service deployment coordination:
T +49 541 1214-365 or -555
hsts.service.germany@honeywell.com

Translation from the German
© 2022 Elster GmbH

Honeywell
krom/schroder