

Burner control unit BCU 56x, 580

OPERATING INSTRUCTIONS

Cert. Version 11.21 · Edition 05.22 · EN · 03251355



1 SAFETY

1.1 Please read and keep in a safe place



Please read through these instructions carefully before installing or operating. Following the installation, pass the instructions on to the operator. This unit must be installed and commissioned in accordance with the regulations and standards in force. These instructions can also be found at www.docuthek.com.

1.2 Explanation of symbols

1, 2, 3, a, b, c = Action

→ = Instruction

1.3 Liability

We will not be held liable for damage resulting from non-observance of the instructions and non-compliant use.

1.4 Safety instructions

Information that is relevant for safety is indicated in the instructions as follows:



DANGER

Indicates potentially fatal situations.



WARNING

Indicates possible danger to life and limb.



CAUTION

Indicates possible material damage.

All interventions may only be carried out by qualified gas technicians. Electrical interventions may only be carried out by qualified electricians.

1.5 Conversion, spare parts

All technical changes are prohibited. Only use OEM spare parts.

CONTENTS

1 Safety	1
2 Checking the usage	2
3 Installation	3
4 Replacing the power module/parameter chip card	3
5 Cable selection	4
6 Wiring	4
7 Connection diagram	5
8 Adjustment	14
9 Commissioning	14
10 Manual mode	15
11 Assistance in the event of malfunction	16
12 Reading off the flame signal, fault messages and the parameters	24
13 Legend	26
14 Technical data	27
15 Logistics	28
16 Accessories	28
17 Certification	29
18 Disposal	30

2 CHECKING THE USAGE

Burner control units BCU 560, 565 and 580 are designed to monitor and control gas burners in intermittent or continuous operation.

The outputs for controlling the burners, for example for fan, actuator and valves, are activated via a replaceable power module. All the parameters required for operation are saved on the integrated parameter chip card.

BCU 560, BCU 565

For directly ignited burners of unlimited capacity.

BCU 580

For pilot and main burners of unlimited capacity. Pilot and main burners can be monitored independently.

BCU..F1, BCU..F2, BCU..F3

Burner control units with interfaces for air control using an air valve or actuators IC 20, IC 40, RBW.

BCU 565..F1, BCU 565..F2, BCU 565..F3

With air flow monitoring as well as pre-ventilation and post-ventilation to control and monitor a self-recuperative burner.

This function is only guaranteed when used within the specified limits – see page 27 (14 Technical data). Any other use is considered as non-compliant.

BCU	Burner control unit
5	Series 500
60	Standard version
65	Extended air control
80	Version for pilot and main burners
Q	Mains voltage: 120 V AC, 50/60 Hz
W	Mains voltage: 230 V AC, 50/60 Hz
C0	No valve proving system
C1	Valve proving system
F0	No capacity control
F1	Modulating with IC interface
F2	Modulating with RBW interface
F3	Air valve control
U0	Ionization or UV control in case of operation with gas
D0	No high temperature operation
D1	High temperature operation
K0	No connection plugs
K1	Connection plugs with screw terminals
K2	Connection plugs with spring force terminals
-E	Individual packaging

2.1 Part designations

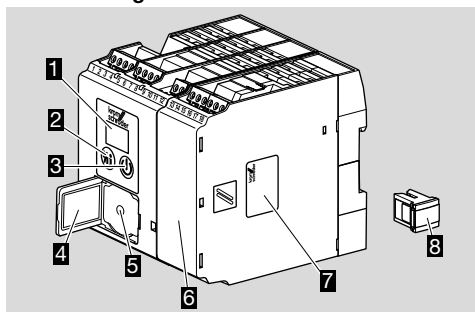

- 1 LED display for program status and fault messages
- 2 Reset/Information button
- 3 On/Off button
- 4 Type label
- 5 Connection for opto-adaptor
- 6 Power module, replaceable
- 7 Power module type label
- 8 Parameter chip card, replaceable
Input voltage – see type label.

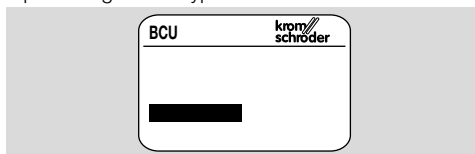

3 INSTALLATION

⚠ CAUTION

Please observe the following to ensure that the BCU is not damaged:

- Dropping the device can cause permanent damage. In this event, replace the entire device and associated modules.
- Installation position: vertically upright, horizontal or tilted to the left or right.
- The BCU mounting is designed for horizontally aligned 35 × 7.5 mm DIN rails.

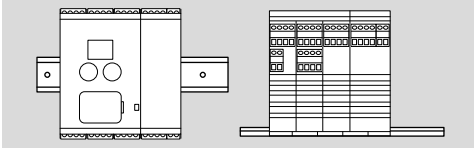

- If the DIN rail is aligned vertically, end clamps are required (e.g. Clipfix 35 by Phoenix Contact) to prevent the BCU from slipping.

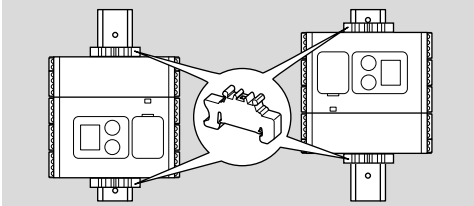

- Install in a clean environment (e.g. a control cabinet) with an enclosure \geq IP 54, whereby no condensation is permitted.

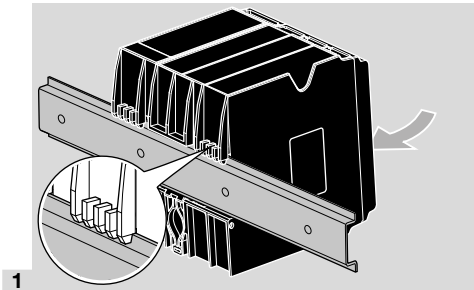

4 REPLACING THE POWER MODULE/ PARAMETER CHIP CARD

- 1 Disconnect the unit from the electrical power supply.

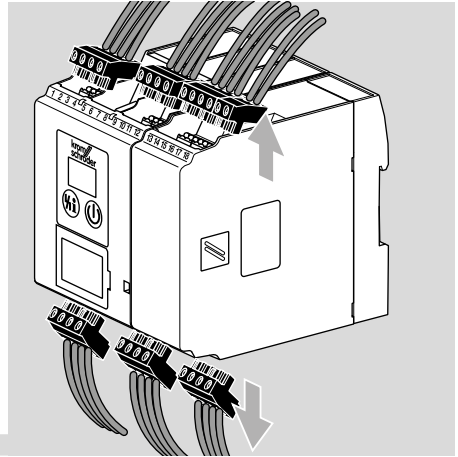

- 2
- 3 Disengage the BCU from the DIN rail.

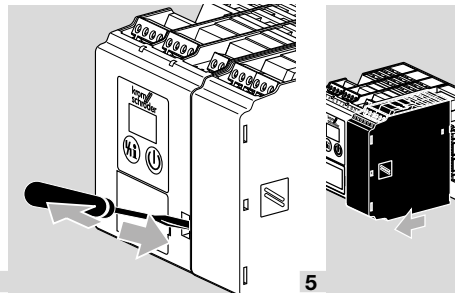

- 4
- 5
- 6 Remove the old parameter chip card from the BCU and insert the new one.

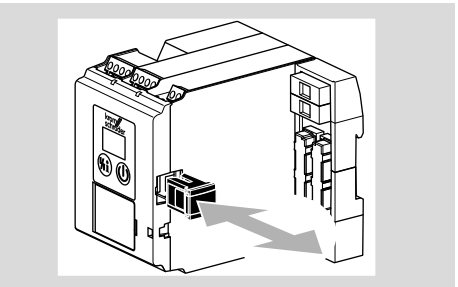

- All the parameter settings of the BCU are saved on the parameter chip card.
- 7 Slide the power module back on.
 - 8 Reconnect the connection terminals.
 - 9 Mount the BCU on the DIN rail again.

5 CABLE SELECTION

- Signal and control line for screw terminals max. 2.5 mm² (min. AWG 24, max. AWG 12), for spring force terminals max. 1.5 mm² (min. AWG 24, max. AWG 12).
- Do not route the BCU cables in the same cable duct as frequency converter cables or cables emitting strong fields.
- The control lines must be selected in accordance with local/national regulations.
- External electrical interference must be avoided.

Ionization cable, UV cable

- Cable lengths of 100 m are acceptable if there is no EMC interference.
- The flame signal is adversely affected by EMC influences.
- Lay cables individually (with low capacitance) and, if possible, not in a metal conduit.

6 WIRING

- Do not reverse phase L1 and neutral conductor N.
- Do not connect different phases of a three-phase current system to the inputs.
- Do not supply voltage to the outputs.
- A short-circuit on the outputs causes one of the replaceable fuses to trip.
- Connect a safety extra-low voltage at 24 V DC \pm 10% to the 24 V DC power supply (terminal 61, 62).
- Do not set the remote reset so that it operates (automatically) in cycles.
- Wire the safety circuit inputs via contacts (relay contacts) only.
- The limiters in the safety interlock (e.g. safety temperature limiter, emergency stop) must isolate terminal 46, as well as the optional safety-relevant inputs at terminals 65 to 68 if these are parameterized, from the voltage supply. If the safety interlock is interrupted, the display shows a blinking 5f as a warning signal and all of the BCU's control outputs are disconnected from the electrical power supply.
- Connected control elements must be equipped with protective circuits in accordance with the manufacturer's instructions. The protective circuit prevents high voltage peaks which can cause malfunctioning of the BCU.
- Observe the maximum duty cycle for the ignition transformer (see manufacturer's instructions). Adjust the minimum pause time t_{BP} (parameter 62) correspondingly, if required.
- Functions of terminals 51, 65, 66, 67 and 68 are dependent on parameter values:

Terminal	Dependent on parameter
51	69
65	70
66	71
67	72
68	73

- 1 Disconnect the system from the electrical power supply.
 - 2 Before wiring, ensure that the yellow parameter chip card has been inserted in the BCU.
- Screw terminals or spring force terminals are available for the BCU:
Screw terminal, Order No.: 74923998.
Spring force terminal, Order No.: 74924000.
 - 3 Wire as shown on the connection diagram – see page 5 (7 Connection diagram).
 - Ensure a good PE (ground) wire connection to the BCU and burners.
 - To safeguard the safety current inputs (terminals 45 to 52 and 65 to 68), the fuse must be designed so that the sensor with the lowest switching capacity is protected.

7 CONNECTION DIAGRAM

BCU 560..F0

→ Legend – see page 26 (13 Legend).

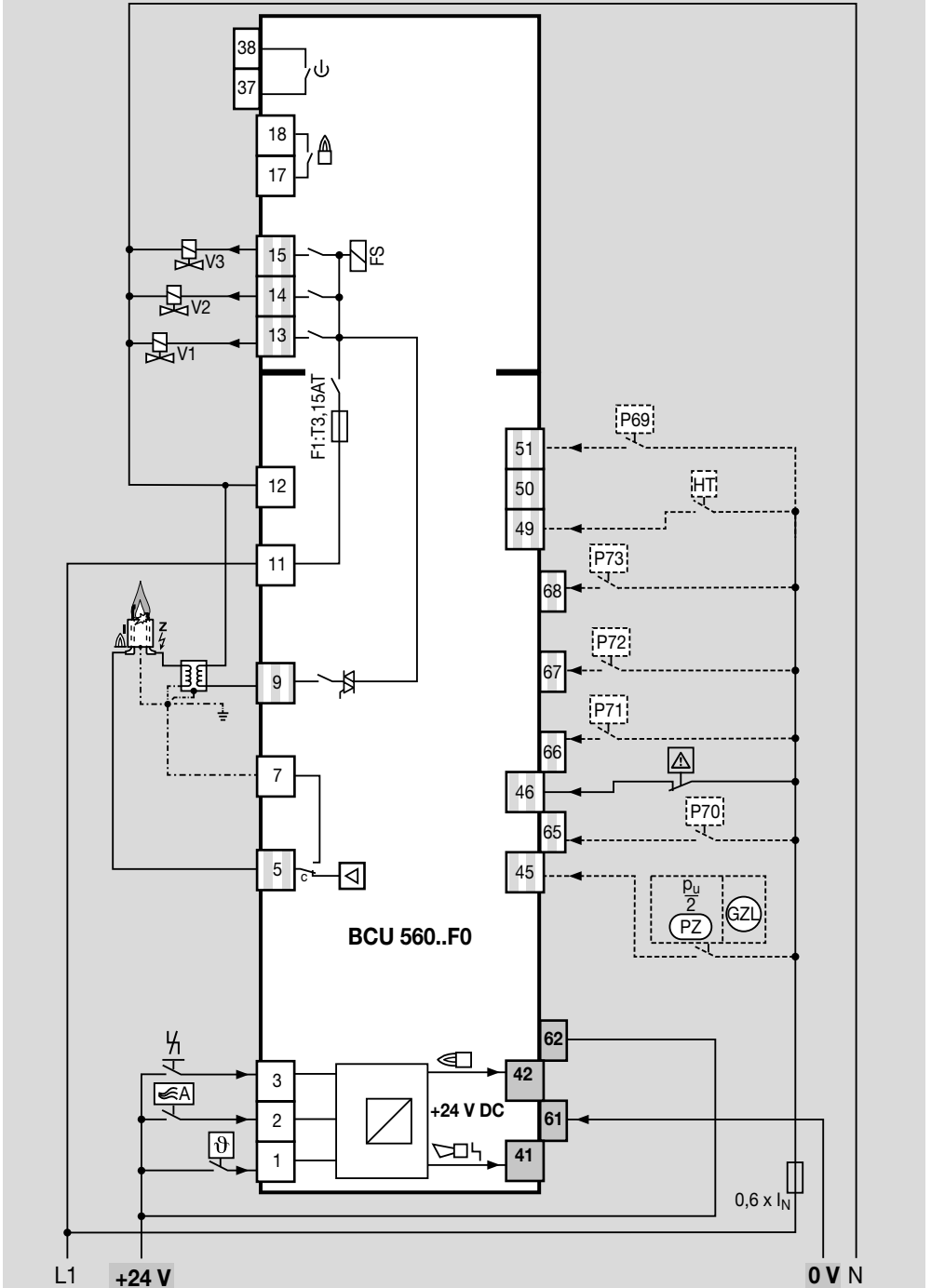

BCU 560..F3

→ Legend – see page 26 (13 Legend).

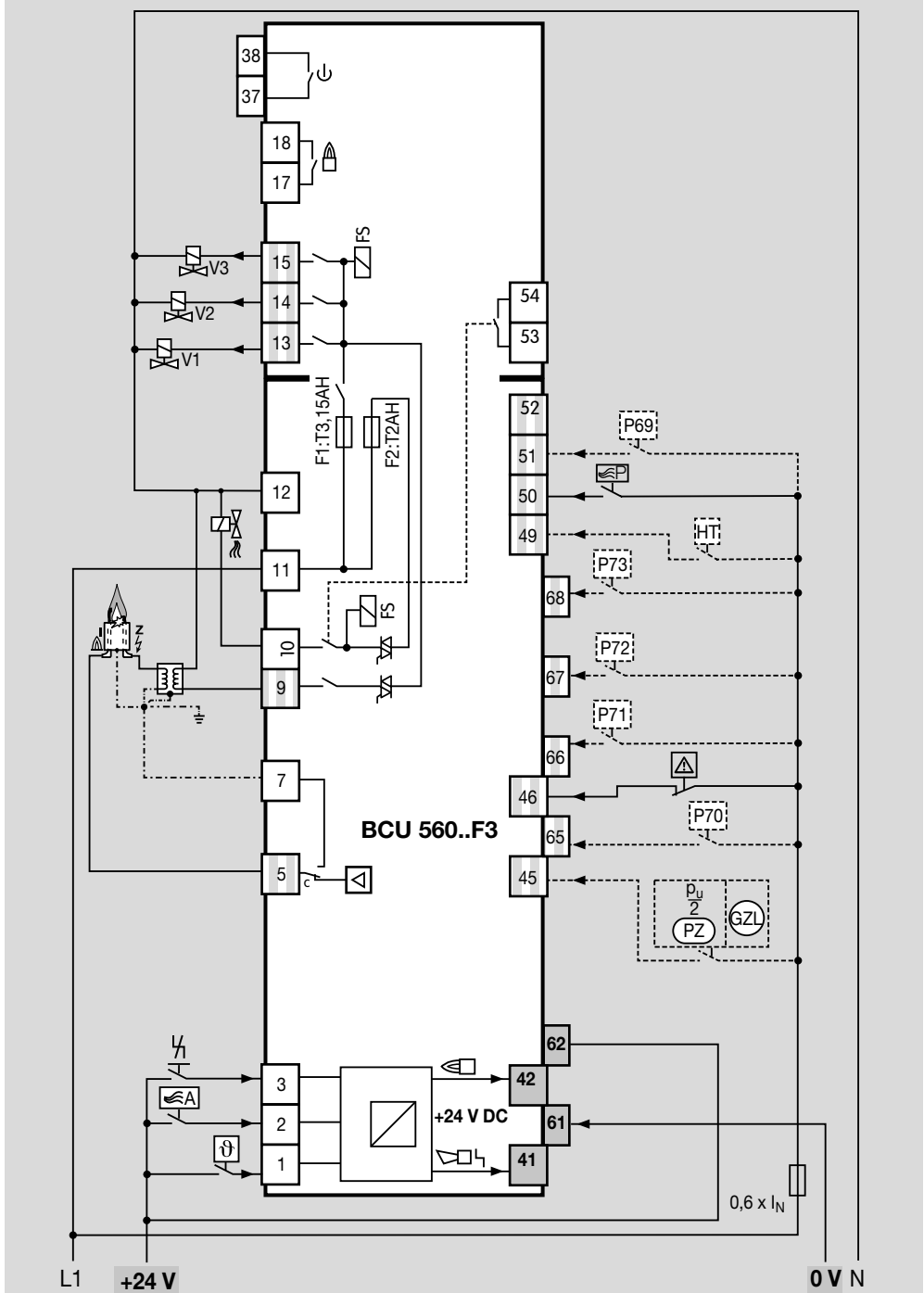

BCU 565..F3

→ Legend – see page 26 (13 Legend).

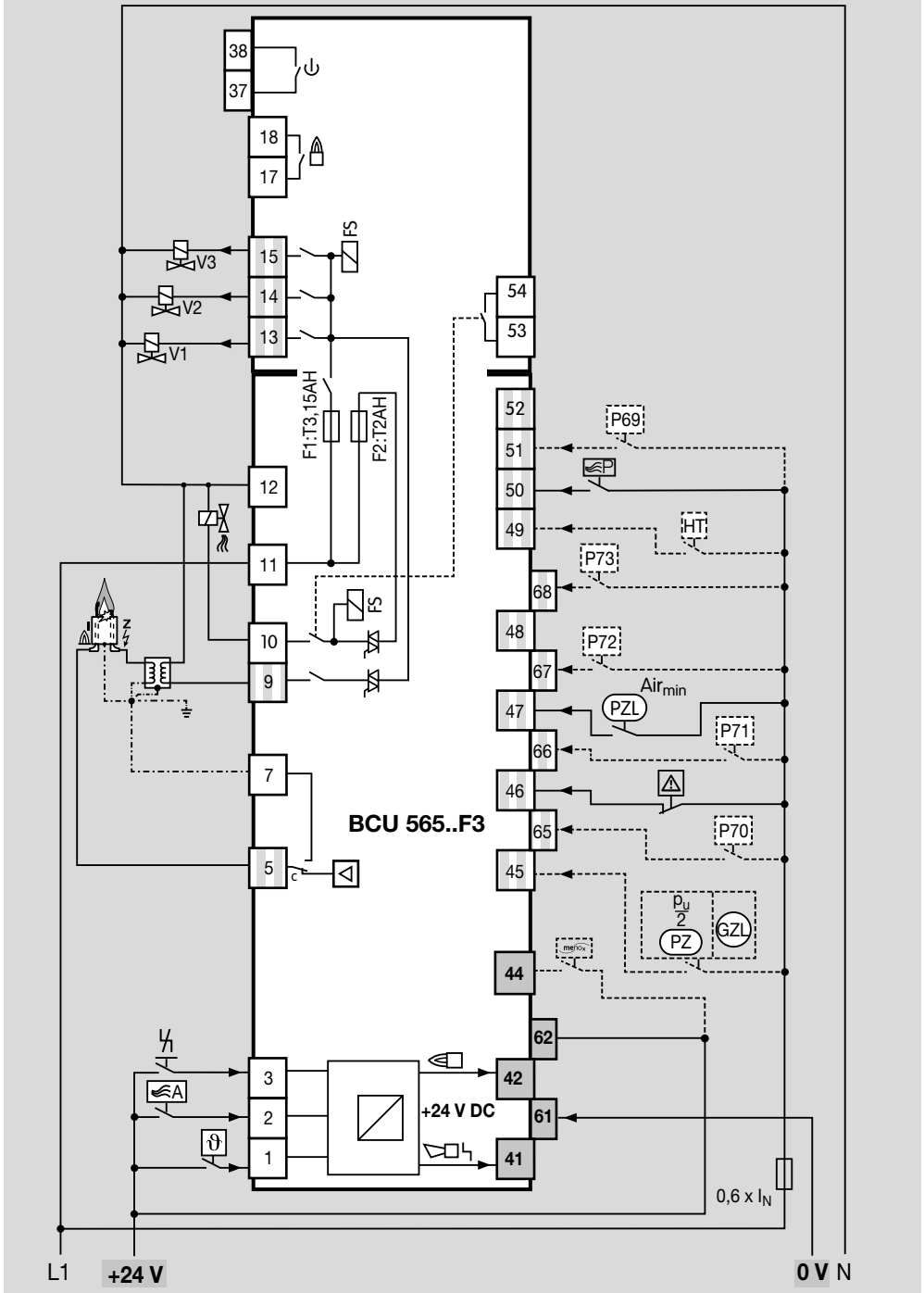

BCU 580..F3

→ Legend – see page 26 (13 Legend).

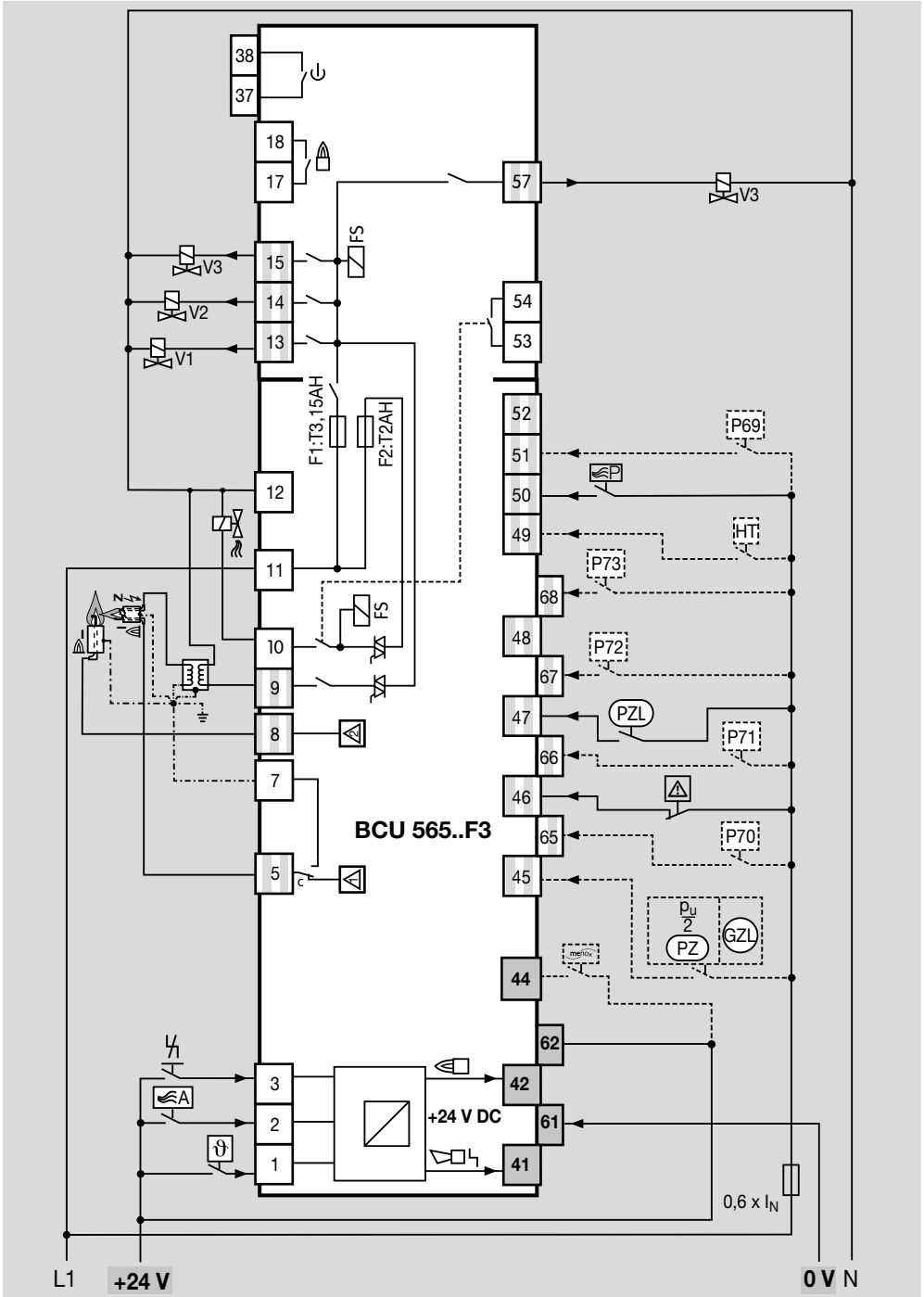

IC 20 connected to BCU..F1

→ Continuous control via three-point step controller.

→ Parameter 40 = 1.

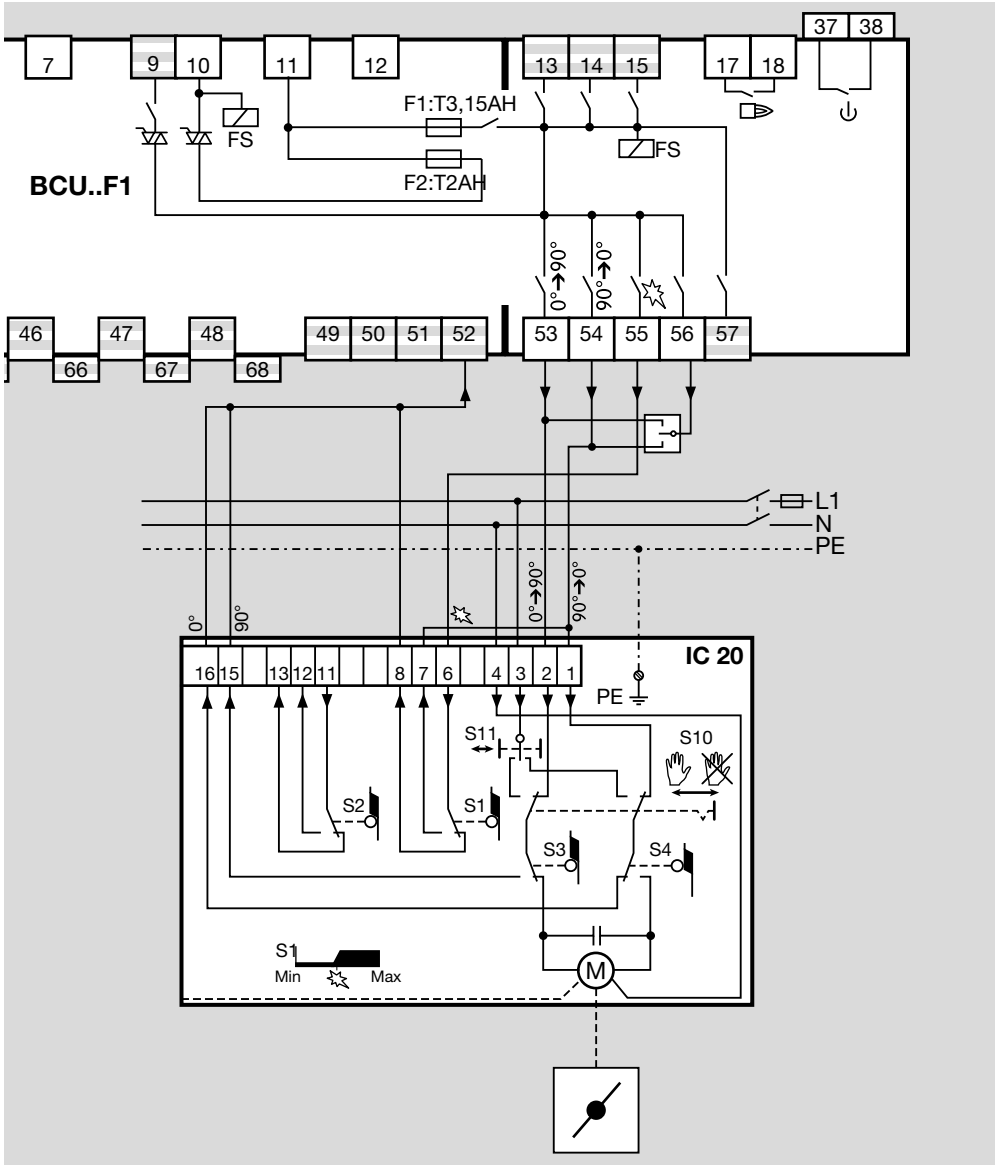

IC 20..E connected to BCU..F1

→ Parameter 40 = 1.

→ Continuous control via an analogue signal (directly connected to the control actuator).

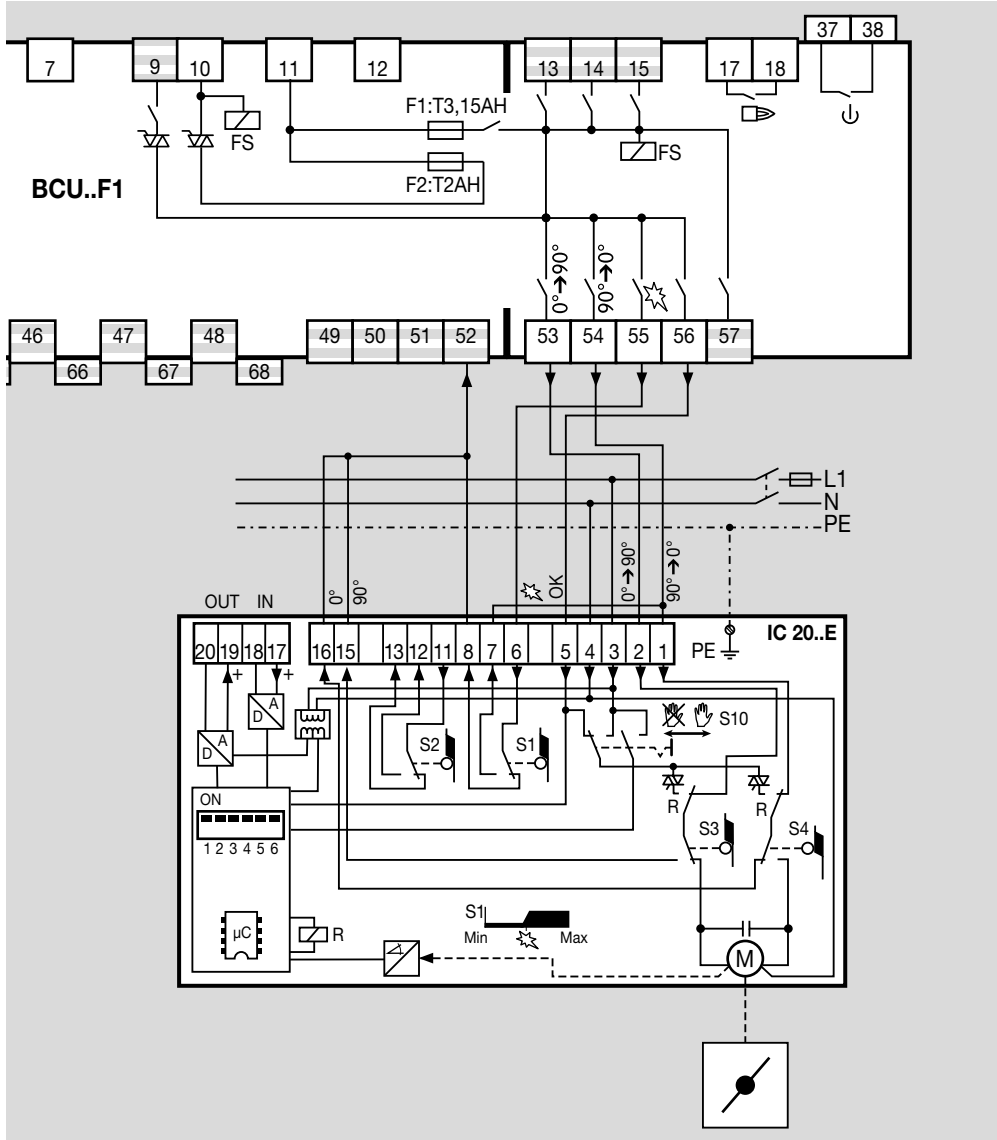

IC 40 connected to BCU..F1

- Parameter 40 = 2.
- Set IC 40 to operating mode 27, see Actuator IC 40 operating instructions or

technical information bulletin at www.docuthek.com.

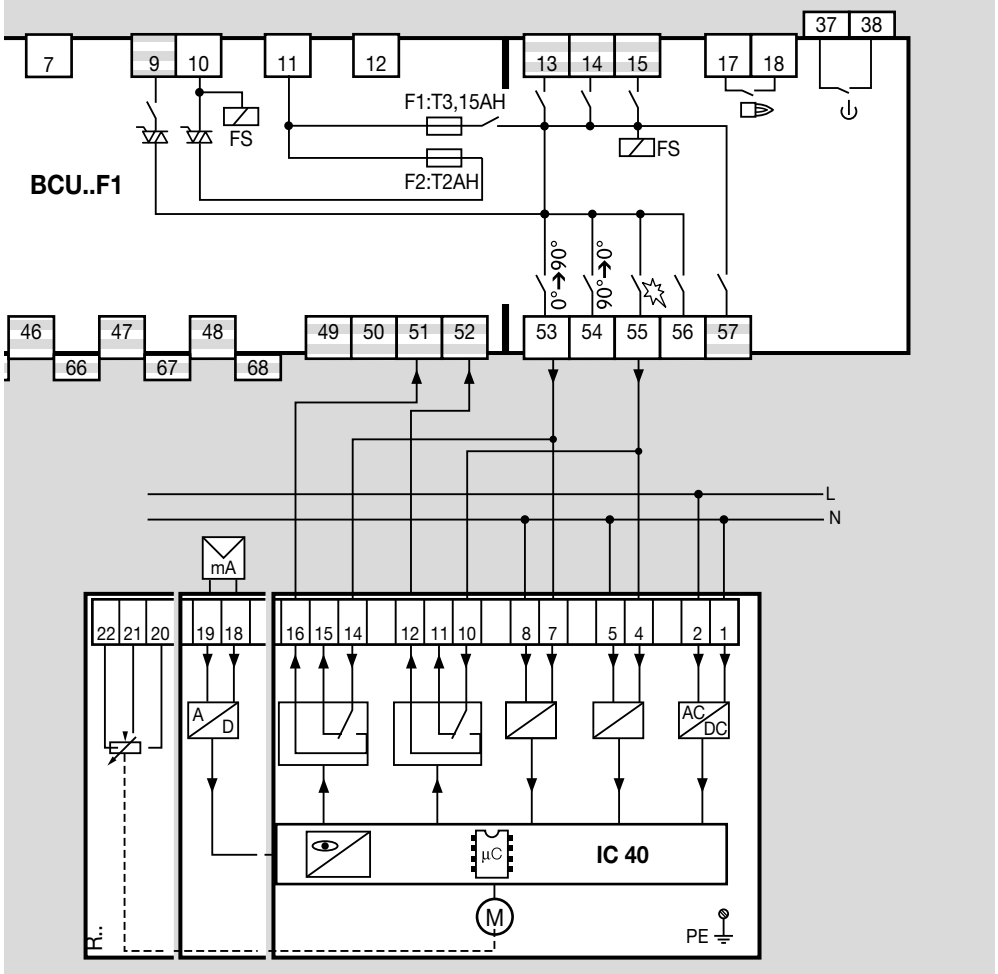

RBW valve connected to BCU..F2

→ Parameter 40 = 3.

Continuous control via three-point step controller

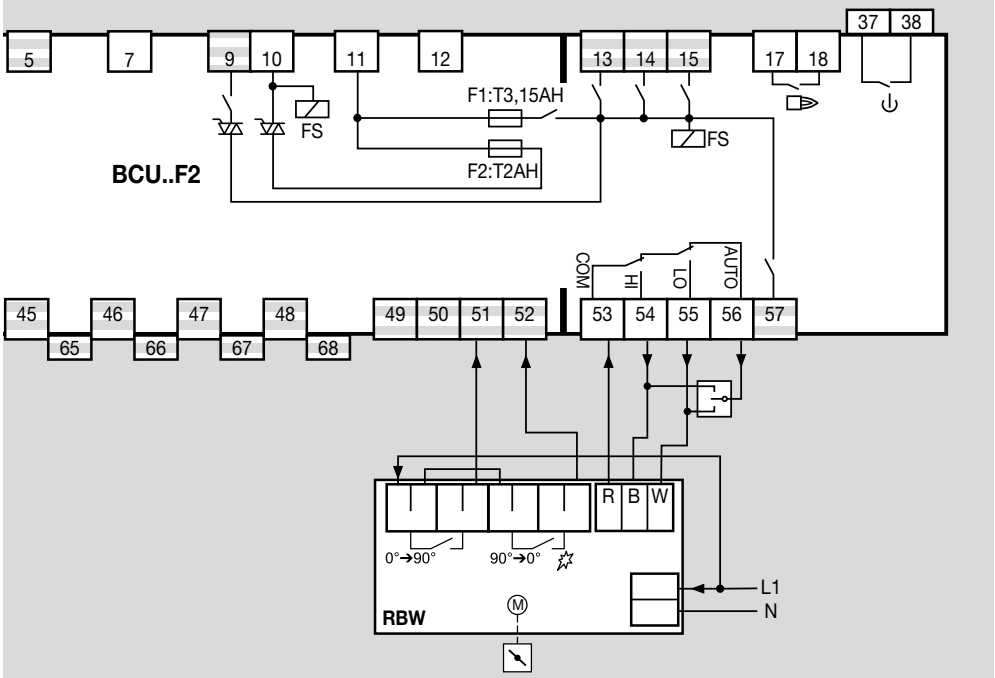

Continuous control via PLC

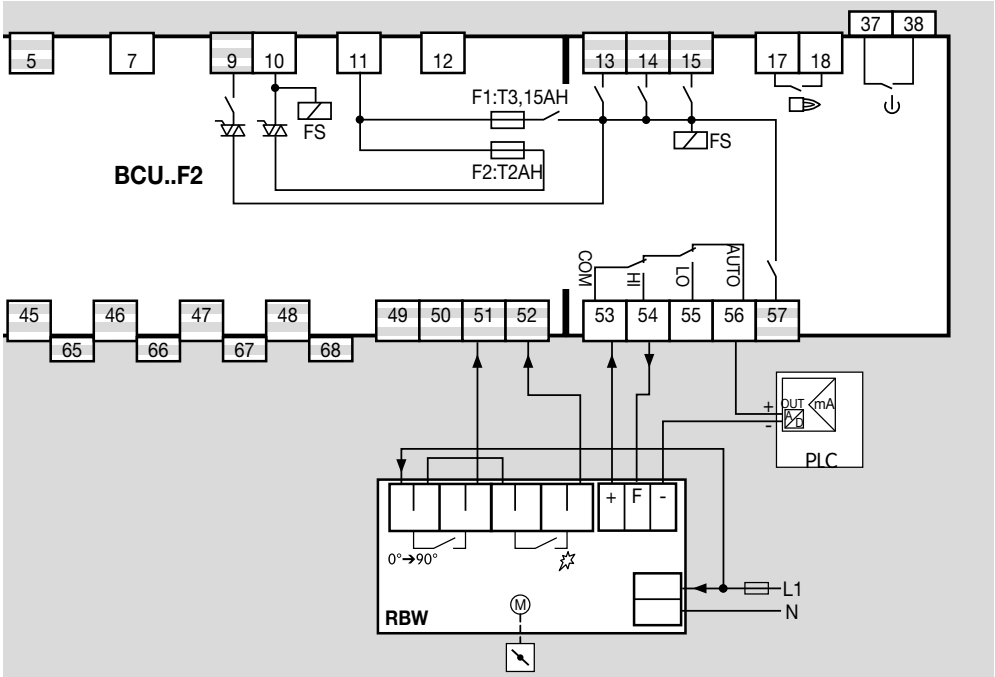

Flame control

- BCU 560, 565 = 1 flame amplifier
- BCU 580 = 2 flame amplifiers
- For UV control, use UV sensors for intermittent operation (UVS 5, 10) or flame detectors for continuous operation (UVC 1).

BCU 560, 565

Double-electrode operation

- See page 5 (7 Connection diagram), BCU 560/LM..F0, BCU 560/LM..F3 and BCU 565/LM..F3.

Ionization/single-electrode operation:

- Parameter 04 = 0.

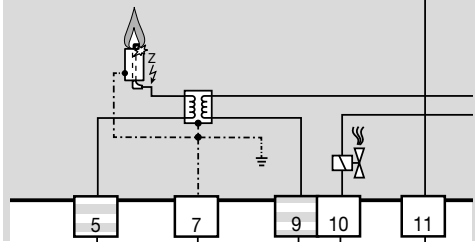

UV control:

UVS 5, 10

- Parameter 01 $\geq 5 \mu\text{A}$.
- Parameter 04 = 3.

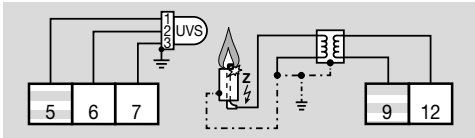

UVC 1

- Parameter 04 = 2.

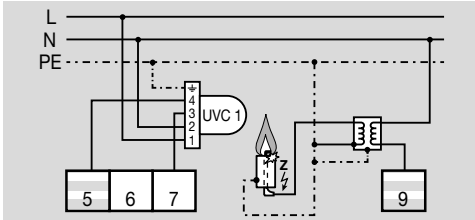

BCU 580

Pilot burner = single-electrode operation/main burner = ionization:

- Pilot burner in single-electrode operation
- Ionization control for main burner
- Parameter 04 = 0

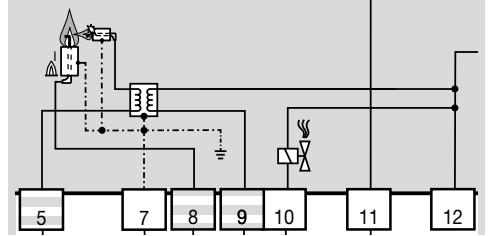

Pilot burner = single-electrode operation/main burner = UVS:

- Parameter 01 $\geq 5 \mu\text{A}$
- Parameter 04 = 3

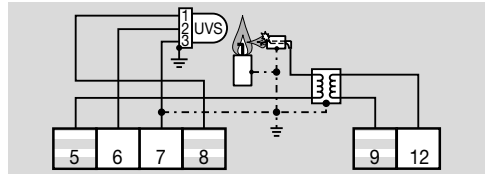

Pilot burner = single-electrode operation/main burner = UVC 1:

- Parameter 04 = 4

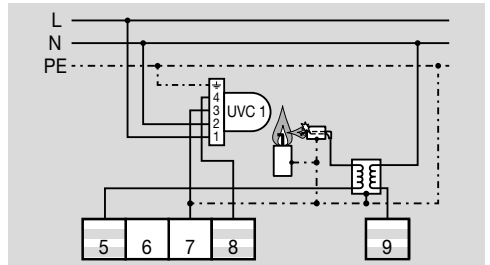

Pilot burner = UVS/main burner = ionization:

- Parameter 02 $\geq 5 \mu\text{A}$
- Parameter 04 = 5

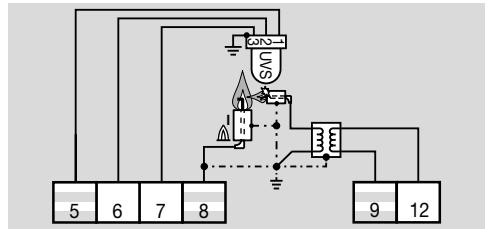

Pilot burner = UVC/main burner = UVC:

→ Parameter 04 = 6

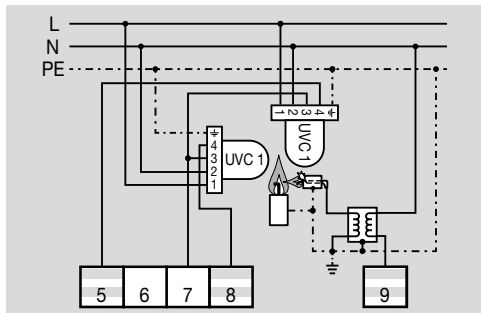

Pilot burner = UVC/main burner = ionization:

→ Parameter 04 = 7

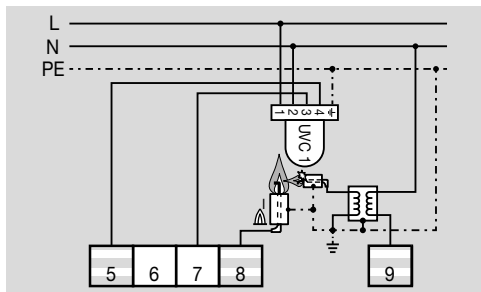

Pilot burner = UVC/main burner = UVS:

→ Parameter 02 ≥ 5 μA

→ Parameter 04 = 8

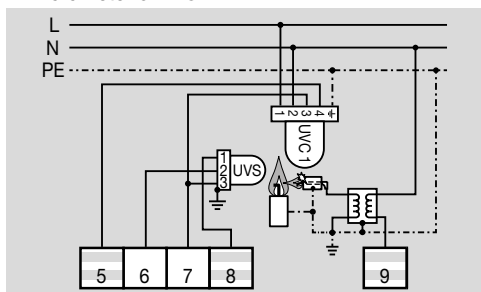

8 ADJUSTMENT

In certain cases, it may be necessary to change the parameters set at the factory. The parameters on the BCU, such as the pre-purge time or the behaviour in the event of a flame failure, can be modified using the separate BCSoft software package and an opto-adapter.

⚠ WARNING

Danger of death!

After modifying the parameters using the BCSoft software, the correct acceptance of the parameters must be checked by pressing the Reset/Information button on the BCU or on the operator-control unit OCU (if connected). For further information on opening the parameter values, see page 24 (12 Reading off the flame signal, fault messages and the parameters).

- The software package and the opto-adapter are available as accessories – see page 28 (16 Accessories).
- Changed parameters are saved on the integrated parameter chip card.
- The factory settings are secured with a programmable password.
- If the password has been changed, the end customer can look up the changed password in the plant documentation or ask the system supplier.

9 COMMISSIONING

→ During operation, the 7-segment display shows the program status:

00	Standby
H0	Delay
Rc	Approaching minimum capacity
R0	Cooling
01	Fan run-up time
R1	Pre-ventilation
R0	Approaching maximum capacity
H1	Delay
P0	Pre-purge
P1	Pre-purge
R1	Approaching ignition capacity
tc	Valve check
02	Safety time 1 t_{SA1}
R2	Safety time 1 t_{SA1}
03	Flame proving period 1 t_{FS1}
R3	Flame proving period 1 t_{FS1}
04	Burner 1 operation
R4	Burner 1 operation
05	Burner 2 waiting time
R5	Delay
H5	Delay time during burner 2 waiting time

<i>06</i>	Safety time 2 t_{SA2}
<i>R6</i>	Safety time 2 t_{SA2}
<i>07</i>	Flame proving period 2 t_{FS2}
<i>R7</i>	Flame proving period 2 t_{FS2}
<i>08</i>	Burner 2 operation
<i>R8</i>	Burner 2 operation
<i>H8</i>	Delay
--	Device Off
[...]	Data transfer (programming mode)
<i>00</i>	(blinking dots) Manual mode
<i>1#</i>	Remote control (with OCU)



WARNING

Risk of explosion!

Check the system for tightness before commissioning.

Do not start the BCU until the parameter settings and wiring are correct and the faultless processing of all input and output signals complies with the local standards.

1 Switch on the system.

→ The display indicates --.

2 Switch on the BCU by pressing the On/Off button.

→ The display indicates *00*.

→ If the display blinks (fault), reset the BCU by pressing the Reset/Information button.

BCU 560..F0

a Apply the start-up signal to terminal 1.

→ The display indicates *01*.

→ The display indicates *02*. The gas valves open and the burner ignites. Safety time 1 starts to elapse.

→ The display indicates *03* during flame proving period 1.

→ The display indicates *04*. The burner is in operation.

BCU 56x..F1, BCU 56x..F3

→ If the air actuator is activated externally for cooling in the start-up position, the display indicates *R0*.

a Apply the start-up signal to terminal 1.

→ The display indicates *01* or *R1* if the air actuator has been activated.

→ The display indicates *02* or *R2* if the air actuator has been opened. The gas valves open and the burner ignites. Safety time 1 starts to elapse.

→ The display indicates *03* during flame proving period 1 or *R3* if the air actuator has been opened.

→ The display indicates *04* or *R4* if the air actuator has been opened. The burner is in operation.

BCU 580..F1/F3

→ If the air actuator is activated externally for cooling in the start-up position, the display indicates *R0*.

a Apply the start-up signal to terminal 1.

→ The display indicates *01* or *R1* if the air actuator has been opened.

→ The display indicates *02* or *R2* if the air actuator has been opened. The gas valves open, the pilot burner (burner 1) ignites and safety time 1 starts to elapse.

→ The display indicates *03* during flame proving period 1 or *R3* if the air actuator has been opened.

→ The display indicates *04* or *R4* if the air actuator has been opened. The pilot burner is in operation.

→ The display indicates *05* or *R5* if the air actuator has been opened. The main burner (burner 2) ignites and safety time 2 starts to elapse.

→ The display indicates *07* during flame proving period 2 or *R7* if the air actuator has been opened.

→ The display indicates *08* or *R8* if the air actuator has been opened. The main burner is in operation. The controller enable signal has been issued.

10 MANUAL MODE

→ For adjustment of the burner control unit or for fault-finding.

→ In manual mode, the BCU operates independently of the status of the inputs for start-up signal (terminal 1), controlled air flow (terminal 2) and remote reset (terminal 3). The function of the controller enable/emergency stop input (terminal 46) is retained.

→ Manual mode is terminated by switching off the BCU or in the event of a power failure.

→ Parameter 67 = 0: Manual mode unlimited in time. The burner control unit may continue to be operated manually in the event of failure of the control system or the bus.

→ Parameter 67 = 1: the BCU will terminate Manual mode 5 minutes after the last time the Reset/Information button is pressed. It switches to the start-up position/standby (display *00*).

1 Switch on the BCU while holding the Reset/Information button. Hold the Reset/Information button until the two dots in the display start to blink.

→ If the Reset/Information button is pressed briefly, the current program step in Manual mode is shown.

→ If the Reset/Information button is pressed for > 1 s, the BCU proceeds to the next program step.

2 Keep pressing the Reset/Information button (for > 1 s at a time) until the BCU has reached the Burner operation program step (BCU 560, 565 = display *04*/BCU 580 = display *08*).

BCU..F1 with IC 20

→ Following the burner operating signal (BCU 56x = display *04*, BCU 580 = display *08*), actuator IC 20 can be opened and closed as required.

3 Press the Reset/Information button.

→ If the button continues to be held down, the actuator opens further until it reaches the position for maximum capacity.

→ The display indicates *R0* with blinking dots.

→ Once the button has been released, the butterfly valve stops in the relevant position.

4 Press the Reset/Information button again.

- If the button continues to be held down, the actuator closes further until it reaches the position for minimum capacity.
- The display indicates *Rc* with blinking dots.
- A change of direction takes place each time the button is released and pressed again. When the butterfly valve has reached its final position, the dots disappear.

BCU..F1 with IC 40, BCU..F2 with RBW

- Following controller enable (BCU 56x = display *04*, BCU 580 = display *00*), it is possible to move between the positions for maximum and minimum capacity on a binary basis.

11 ASSISTANCE IN THE EVENT OF MALFUNCTION

DANGER

To avoid harm to persons and damage to the unit, please observe the following:

- Electric shocks can be fatal! Before working on possible live components, ensure the unit is disconnected from the power supply.
- Fault-clearance must only be undertaken by authorized trained personnel.
- Faults may be cleared only using the measures described below.
- If the BCU does not respond even though all faults have been remedied: remove the unit and return it to the manufacturer for inspection.
- System faults (faults 10, 20, 23, 24, 30, 31, 32, 33, 36, 51, 52, 80, 89, 94–99, bE and bc) can only be acknowledged using the Reset/Information button on the BCU.
- The BCU shows warning messages (n0 to n4) in the display. The BCU can continue to be operated via the control inputs.
- If fault lock-out has been programmed, faults d1 to d8 must be acknowledged using the Reset/Information button. If safety shut-down has been programmed, no fault signal is sent via the fault signalling contact. As soon as the faults no longer exist, the fault messages on the display disappear. These faults do not have to be acknowledged using the Reset/Information button.

? **Faults**

! Cause

- Remedy

? **The 7-segment display does not light up.**

! Mains voltage is not applied.

- Check the wiring, apply mains voltage (see type label).



? **The display blinks and indicates 01 or R1.**

- ! The BCU has detected an incorrect flame signal without the burner having been ignited (extraneous signal).
 - Direct the UV sensor exactly at the burner to be monitored.
- ! UV tube in the UV sensor is defective (service life ended) and issues a continuous flame signal.
 - Replace the UV tube, see UV sensor operating instructions.
- ! Flame signal through conductive ceramic insulation.
 - Increase value of parameter 01 to adapt the switch-off threshold of the flame amplifier for burner 1.



? **Start-up – no ignition spark – the display blinks and indicates 02 or R2.**

- ! The ignition cable is too long.
 - Shorten it to 1 m (max. 5 m).
- ! Gap between spark electrode and burner head is too great.
 - Adjust gap to max. 2 mm.
- ! Ignition cable has no contact in the terminal boot.
 - Screw the cable on firmly.
- ! Ignition cable has no contact in the ignition transformer.
 - Check the connection.
- ! Ignition cable has short-circuited to ground.
 - Check installation, clean the spark electrode.
 - If the fault cannot be remedied by doing this, remove the unit and return it to the manufacturer for inspection.

? **Start-up without flame – no gas supply – the display blinks and indicates 02 or R2.**

- ! A gas valve does not open.
 - Check the gas pressure.
 - Check voltage supply to the gas valve.
- ! There is still air in the pipe, e.g. after installation work has been carried out or if the system has not been in operation for a long period.
 - “Purge” the pipeline and reset the BCU.
 - If the fault cannot be remedied by doing this, remove the unit and return it to the manufacturer for inspection.

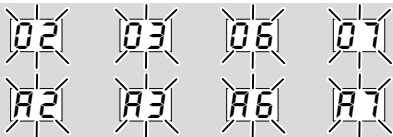

? **Start-up – flame burning – nevertheless, the display blinks and indicates 2 or 3 on the pilot burner/burner (burner 1) or 6 or 7 on the main burner (burner 2).**

! Flame failure on start-up.

- Read off the flame signal.

→ If the flame signal is lower than the switch-off threshold for the flame signal from burner 1 (parameter 01) or burner 2 (parameter 02), this may be attributable to the following causes:

! The set value for the cut-off sensitivity is too high.

! Short-circuit on the flame rod as the result of soot, dirt or moisture on the insulator.

! Flame rod not correctly positioned at the flame edge.

! Terminal boot not properly connected to flame rod.

! Gas/air ratio incorrect.

! Flame not contacting burner ground as the result of excessively high gas or air pressure.

! Burner or BCU not (adequately) grounded.

! Short-circuit or discontinuity on the flame signal cable.

! Soiled UV sensor.

! UV sensor wiring is defective.

- Remedy fault.



? **The display blinks and indicates 05 or A5.**

! The BCU has detected an incorrect flame signal without burner 2 (main burner) having been ignited (extraneous signal).

- Direct the UV sensor exactly at burner 2 to be monitored.

! UV tube in the UV sensor is defective (service life ended) and issues a continuous flame signal.

- Replace the UV tube, see UV sensor operating instructions.

! Flame signal through conductive ceramic insulation.

- Increase value of parameter 02 to adapt the switch-off threshold of the flame amplifier for burner 2.



? **Operation – flame burning – burner 2 interrupted – the display blinks and indicates 08 or A8.**

! Flame failure during operation or during delayed controller enable.

- Read off the flame signal, see page 24 (12 Reading off the flame signal, fault messages and the parameters).

→ If the flame signal is lower than the switch-off threshold for the flame signal from burner 2 (parameter 02), this may be attributable to the following causes:

! The set value for the cut-off sensitivity is too high.

! Short-circuit on the flame rod as the result of soot, dirt or moisture on the insulator.

! Flame rod not correctly positioned at the flame edge.

! Gas/air ratio incorrect.

! Flame not contacting burner ground as the result of excessively high gas or air pressure.

! Burner or BCU not (adequately) grounded.

! Short-circuit or discontinuity on the flame signal cable.

! Soiled UV sensor.

- Remedy fault.



? **The display blinks and indicates 10.**

! Actuation of the remote reset input is faulty.

! Too many remote resets. More than 5 resets have been conducted within the last 15 minutes, either automatically or manually.

! Consecutive fault caused by a previous fault whose actual cause has not been remedied.

- Pay attention to previous fault messages.
- Remedy cause.

→ The cause will not be remedied by performing a reset every time a fault lock-out occurs.

- Check whether remote reset complies with standards (EN 746 allows resetting only under supervision) and correct if necessary.

→ The BCU may only be reset manually under supervision.

- Press the Reset/Information button on the BCU.



? The display blinks and indicates 11.

! Too many restarts for burner 1. More than 5 restarts initiated within the last 15 minutes.

- Check burner settings.
- Check the settings for capacity control during operation.
- Press the Reset/Information button on the BCU.



? The display blinks and indicates 12.

! Too many restarts for burner 2. More than 5 restarts initiated within the last 15 minutes.

- Check burner settings.
- Press the Reset/Information button on the BCU.



? The display blinks and indicates 20.

! Voltage is applied to the output at terminal 56.

- Check the wiring and ensure that the voltage outputs and inputs have the same polarity and are not reversed.

! The unit has suffered an internal error in the power module.

- Replace the power module.



? The display blinks and indicates 21.

! Inputs 51 and 52 are activated simultaneously.

- Check input 51.

→ Input 51 may only be activated if the valve is open.

- Check input 52.

→ Input 52 may only be activated if the valve is in the position for ignition capacity.



? The display blinks and indicates 22.

! Actuator IC 20 has been wired incorrectly.

- Check the wiring. Wire the outputs and inputs of connection terminals 52–55 as shown in the connection diagram – see page 9 (IC 20 connected to BCU..F1).

! The unit has suffered an internal error in the power module.

- Replace the power module.



? The display blinks and indicates 23.

! The butterfly valve position is not constantly signalled back to the BCU.

- Check the wiring and ensure that the position for max. capacity/ignition capacity/closed of the butterfly valve is constantly signalled back via terminal 52.



? The display blinks and indicates 24.

! Faulty activation via the bus. Requirements for “Open” and “Close” set simultaneously.

- Ensure that “Open” and “Close” are not activated simultaneously.



? The display blinks and indicates 30 or 31.

! Abnormal data change in the parameters set for the BCU.

- Reset the parameters to their original values using the BCSofT software.
- Establish the cause of the fault to avoid repeat faults.
- Ensure that the cables have been installed properly – see page 4 (5 Cable selection).
- If the measures described above do not help, remove the unit and return it to the manufacturer for inspection.



? The display blinks and indicates 32.

! Supply voltage too low or too high.

- Operate the BCU in the specified mains voltage range (mains voltage +10/-15%, 50/60 Hz).

! An internal device error occurred.

- Remove the unit and return it to the manufacturer for inspection.



? The display blinks and indicates 33.

! Faulty parameterization.

- Check parameter settings using BCSoft and adjust them if necessary.

- !** An internal device error occurred.
- Remove the unit and return it to the manufacturer for inspection.



? The display blinks and indicates 34.

- !** Faulty actuation of the air valve.
- !** An internal device error occurred.
- Remove the unit and return it to the manufacturer for inspection.



? The display blinks and indicates 35.

- !** Bus module and control unit are incompatible.
- Check the bus system and PLC for PROFIBUS compatibility.
- !** Bus module does not support the selected function.
- Check the setting of parameter 75.



? The display blinks and indicates 36.

- !** Voltage is applied to the gas valve outputs.
- Check the wiring and ensure that the voltage outputs and inputs have the same polarity and are not reversed.
- !** An internal device error occurred.
- Replace the power module.
 - Remove the unit and return it to the manufacturer for inspection.



? The display blinks and indicates 39.

- !** Short-circuit on one of the outputs of the safety circuit.
- Check the wiring.
 - Check fine-wire fuse F1 (3.15 A, slow-acting, H).
- The fine-wire fuse can be replaced once the power module has been removed.
- Then check the faultless processing of all input and output signals.
- !** The unit has suffered an internal error in the power module.
- Replace the power module.



? The display blinks and indicates 40.

- !** The gas solenoid valve V1 is leaking.
- Check the gas solenoid valve V1.
- !** The gas pressure switch DGp_V/2 for the tightness test has been set incorrectly.
- Check the inlet pressure.
 - Set DGp_V/2 to the correct inlet pressure.
 - Check the wiring.
- !** The test pressure between V1 and V2 has not decreased.
- Check the installation.
- !** The test period is too long.
- Check parameter 56 (Measurement time for V_{p1}) and change it using BCSoft.
 - If the fault cannot be remedied by doing this, remove the unit and return it to the manufacturer for inspection.



? The display blinks and indicates 41.

- !** The downstream gas solenoid valve (V2) is leaking.
- Check the downstream solenoid valve.
- !** The gas pressure switch DGp_V/2 for the tightness test has been set incorrectly.
- Check the inlet pressure.
 - Set DGp_V/2 to the correct pressure.
 - Check the wiring.
- !** The test period is too long.
- Check parameter 56 (Measurement time for V_{p1}) and change it using BCSoft.
 - If the fault cannot be remedied by doing this, remove the unit and return it to the manufacturer for inspection.



? The display blinks and indicates 42.

- !** One of the burner-side gas solenoid valves (V2/V3) is leaking.
- Check the burner-side solenoid valves.
- !** The gas pressure switch DGp_V/2 for the tightness test has been set incorrectly.
- Check the inlet pressure.
 - Set DGp_V/2 to the correct inlet pressure.
 - Check the wiring.
- !** The test period is too long.
- Change parameter 56 (Measurement time for V_{p1}) using BCSoft.

- If the fault cannot be remedied by doing this, remove the unit and return it to the manufacturer for inspection.

45

? The display blinks and indicates 45.

- !** Faulty valve actuation, reversed valve connection.
- Check the wiring of the solenoid valves.

51

? The display blinks and indicates 51.

- !** Interruption of signal at the “Safety interlock/Controller enable/Emergency stop” input (terminal 46).
- Check actuation of “Safety interlock/Controller enable/Emergency stop” input (terminal 46).

52

? The display blinks and indicates 52.

- !** The BCU is permanently reset by remote reset.
- Check remote reset activation (terminal 3).
 - Apply signal to terminal 3 for approx. 1 second to reset only.

53

? The display blinks and indicates 53.

- !** The time between two starts is less than the min. time (timing cycle).

$$t_{z_{\min}} [s] = (t_{VZ} + 0.6 \times t_{SA1}) + 9$$

Example:

Pre-ignition time $t_{VZ} = 2$ s

1st safety time on start-up $t_{SA1} = 3$ s

$$t_{z_{\min}} = (2 + 0.6 \times 3) + 9 = 12.8 \text{ s}$$

54

? The display blinks and indicates 54.

- !** Faulty feedback signal of the control element position for ignition capacity.
- Check wiring from central actuator to BCU (terminal 66).

- Check whether parameter 71 = 20 (LDS ignition position check).

56

? The display blinks and indicates 56.

- !** Faulty wiring of multi-flame control. A flame signal and an incorrect flame signal are sent to the BCU at the same time.
- Check the wiring.

57

? The display blinks and indicates 57.

- !** Faulty actuation of the input at terminal 44. The BCU is prompted to go into menox mode, even though there is no signal for high temperature operation (> 750°C) at terminal 49.
- Check the wiring.

89 94 95 96
98 99

? The display blinks and indicates 89, 94, 95, 96, 97, 98 or 99.

- !** System fault – the BCU has performed a safety shut-down. The cause may be a unit defect or abnormal EMC influence.
- Ensure that the ignition cable has been installed properly – see page 4 (5 Cable selection).
 - Ensure that the EMC regulations for the system are satisfied – particularly for systems with frequency converters – see page 4 (5 Cable selection).
 - Reset the unit.
 - Disconnect the burner control unit from the mains supply and then switch it on again.
 - Check mains voltage and frequency.
 - If the measures described above do not help, the unit has probably suffered a hardware defect – remove the unit and return it to the manufacturer for inspection.

94

? The display blinks and indicates 94.

- !** The inputs are supplied with different phases of a three-phase current system.

- Check the wiring and ensure that the device and the inputs are supplied with the same phase.



? The display blinks and indicates 97.

- !** No PCC.
 - Insert compatible PCC.
- !** Contact problems on the power module.
 - Remedy contact problems.
- !** Power module is defective.
 - Replace power module.
 - If the measures described above do not help, the unit has probably suffered a hardware defect – remove the unit and return it to the manufacturer for inspection.

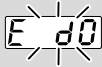

? The display blinks and indicates d 0.

- !** The “no flow” state check of the air pressure switch has failed.
 - Check the function of the air pressure switch.
- Before the fan is switched on, there must be no High signal at the input for air monitoring (terminal 47) when air monitoring is activated.



? The display blinks and indicates d 1.

- !** The operating check of the air pressure switch has failed. The air monitor, depending on the parameter setting for input 47 or 48 (P15 and P35), has not switched after fan start-up.
 - Check the air monitor wiring.
 - Check the air pressure switch setpoint.
 - Check the function of the fan.



? The display blinks and indicates d P.

- !** The input signal (terminal 48) from the air pressure switch has dropped out during pre-purge.
 - Check the air supply during the purging process.
 - Check the electrical wiring of the air pressure switch.
 - Check voltage supply to terminal 48.
 - Check the air pressure switch setpoint.



? The display blinks and indicates 80.

- !** Error in flame amplifier, burner 1.
 - Remove the unit and return it to the manufacturer for inspection.



? The display blinks and indicates 85.

- !** Error in flame amplifier, burner 2.
 - Remove the unit and return it to the manufacturer for inspection.

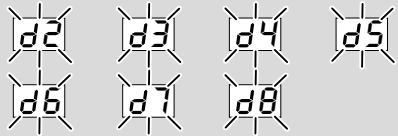

? The display blinks and indicates d 2, d 3, d 4, d 5, d 6, d 7 or d 8.

- !** The input signal from the air pressure switch has dropped out during start-up/operation at program step X (02 to 08).
- !** Failure of the air supply at program step X.
 - Check the air supply.
 - Check the air pressure switch setpoint.



? The display blinks and indicates Ac.

- !** No “Minimum capacity reached” signal from actuator.
 - Check the butterfly valve and the function of the limit switches in the actuator.
 - Check the wiring.
 - Check the actuator.
 - If the fault cannot be remedied by doing this, remove the unit and return it to the manufacturer for inspection.



? The display blinks and indicates A0.

- !** No “Maximum capacity reached” signal from actuator.
 - Check the butterfly valve and the function of the limit switches in the actuator.
 - Check the wiring.
 - Check the actuator.

- If the fault cannot be remedied by doing this, remove the unit and return it to the manufacturer for inspection.



? The display blinks and indicates A1.

! No "Ignition capacity reached" signal from actuator.

- Check the butterfly valve and the function of the limit switches in the actuator.
- Check the wiring.
- Check the actuator.
- If the fault cannot be remedied by doing this, remove the unit and return it to the manufacturer for inspection.



? The display blinks and indicates b E.

! Internal communication with bus module has suffered a fault.

- Check bus module connection.
- Connected control elements must be equipped with protective circuits in accordance with the manufacturer's instructions.

→ This prevents high voltage peaks which can cause malfunctioning of the BCU.

- Use interference-suppressed terminal boots (1 kΩ).
- If the fault cannot be remedied by doing this, remove the unit and return it to the manufacturer for inspection.

! Bus module is defective.

- Replace the bus module.



? The display blinks and indicates bc.

! Incorrect or defective parameter chip card (PCC).

- Only the intended parameter chip card is to be used.
- Replace defective parameter chip card.



? The display blinks and indicates c 1.

! No input signal from the valve proof of closure switch (POC) during standby.

- Check the wiring.

→ Mains voltage must be supplied to the BCU (terminal 45) if the valve is closed and no voltage is to be applied if the valve is open.

- Check that the proof of closure switch and valve function perfectly, replace defective valves.



? The display blinks and indicates c θ.

! The BCU is receiving no information as to whether the POC switch contact is still open.

- Check the wiring.
- Check parameterization of inputs at terminals 36, 37 and 38.

→ During start-up, mains voltage must be supplied to the BCU (terminal 45) if the valve is closed and no voltage is to be applied if the valve is open.

- Check that the proof of closure switch and valve function perfectly, replace defective valves.



? The display blinks and indicates F1.

! One of the external flame detectors detects an extraneous signal (an incorrect flame signal).

- Eliminate extraneous signal.

! Incorrect voltage supply to terminal 67.

- Check voltage supply to terminal 67.



? The display blinks and indicates F2.

! One of the external flame detectors does not detect a flame signal during the safety time.

- Check voltage supply to terminal 68.



? The display blinks and indicates F3.

! One of the external flame detectors does not detect a flame signal during the flame proving period.

- Check voltage supply to terminal 68.



? The display blinks and indicates F4.

! One of the external flame detectors does not detect a flame signal during operation.

- Check voltage supply to terminal 68.



? The display blinks and indicates n 0.

- ! No connection established between BCU and PLC.
- Check the wiring.
 - Check the PLC program to ensure that the network name and IP configuration of the BCU are valid.
 - Switch on the PLC.



? The display blinks and indicates n 1.

- Fault occurs on devices with fieldbus communication with address check (P80 = 1) only.
- ! An invalid or incorrect address has been set on the bus module.
- Assign the correct address (001 to FEF) to the bus module.



? The display blinks and indicates n 2.

- ! The bus module has received an incorrect configuration from the PLC.
- Check whether the correct GSD file was imported.



? The display blinks and indicates n 3.

- Fault occurs on devices with fieldbus communication with address check (P80 = 1) only.
- ! The BCU has been assigned an invalid network name or has not been assigned a network name in the PLC.
- Assign a network name corresponding to the default network name (bcu-560-xxx) or use the default name as a suffix of an individually assigned name in the following form: "individual-partofnamebcu-560-xxx".
- "xxx" stands for the address set on the bus module (e.g. 4A5).



? The display blinks and indicates n 4.

- ! PLC in STOP position.
- Check whether the PLC can be started.

Replacing the fuse

- The device fuses F1 and F2 can be removed for inspection.
- 1 Disconnect the system/BCU from the electrical power supply.
 - 2 Disconnect the connection terminals from the BCU.
- The connection cables may remain screwed to the connection terminals.
- 3 Disconnect the power module, see page 3 (4 Replacing the power module/parameter chip card).
 - 4 Remove the fuse holder (with fine-wire fuse F1 or F2).

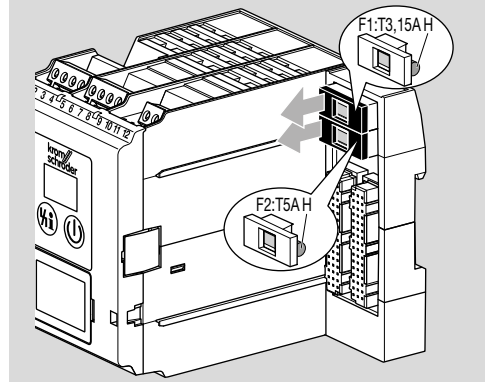

- 5 Check fine-wire fuse F1 or F2 for correct functioning.
 - 6 Replace the fine-wire fuse if defective.
- When replacing the fuse, use only the approved fuse type (F1: 3.15 A, slow-acting, H, F2: 5 A, slow-acting, H, pursuant to IEC 60127-2/5).
- 7 First reconnect the power module, then reconnect the connection terminals and restart the system/BCU, see also page 14 (9 Commissioning).

12 READING OFF THE FLAME SIGNAL, FAULT MESSAGES AND THE PARAMETERS

→ During operation (BCU 56x = display 04, BCU 580 = display 08), information about the flame signal intensity, the last 10 fault messages and the parameter values can be read off by repeatedly pressing the Reset/Information button.

Display	Information
F1 F2*	Flame signal intensity Burner 1 Burner 2*
E8 to E9	Last fault message to tenth to last fault message
01 to 99	Parameter 01 to Parameter 99

* Only on BCU 580

- 1 Press the Reset/Information button for approx. 2 s until the display indicates F1.
 - 2 Release the button. The display indicates the flame signal intensity in μA .
 - 3 Press the Reset/Information button again for 2 s to go to the next item of information (fault message, parameter value).
- Each time the button is released, the corresponding fault message or parameter value is displayed.
- To go to one of the last fault messages or to a parameter more quickly, hold the Reset/Information button pressed down for longer (≥ 2 s).
- If the button is pressed briefly, the display indicates what parameter number is currently being displayed.
- The normal program status is displayed again approx. 60 seconds after the last time the button is pressed.
- If an operator-control unit OCU is connected, information about the flame signal intensity, fault messages and parameter values can only be queried using the OCU.

12.1 Parameters and values

Parameter	
No.	Name Value
01	Switch-off threshold 1 2-20 = μA
02	Switch-off threshold 2 2-20 = μA
04	Flame control 0 = Ionization 1 = UVS 2 = UVC 3 = Ionization 1 and UVS 2 4 = Ionization 1 and UVC 2 5 = UVS 1 and ionization 2 6 = UVC 1 and UVC 2 7 = UVC 1 and ionization 2 8 = UVC 1 und UVS 2
06	High temperature operation 0 = Off 2 = Intermittent operation with UVS 3 = Continuous operation with ionization/ UVC 5 = menox intermittent
07	Burner 1 start-up attempts 1 = 1 start-up attempt 2 = 2 start-up attempts 3 = 3 start-up attempts
08	Burner 2 start-up attempts 1 = 1 start-up attempt 2 = 2 start-up attempts 3 = 3 start-up attempts
09	Restart 0 = Off 1 = Burner 1 2 = Burner 2 3 = Burner 1 and burner 2 (pilot and main burners) 4 = Burner 1 max. 5 x in 15 min. 5 = Burner 2 max. 5 x in 15 min. 6 = Burner 1 & 2 max. 5 x in 15 min.
15	Low air pressure protection 0 = Off 1 = With safety shut-down 2 = With fault lock-out
16	Delayed low air pressure protection 0 = Off 1 = On
19	Safety time during operation 0; 1; 2 = Time in seconds
28	menox pre-ventilation t_{VLM} 0-250 = Time in seconds
34	Pre-purge time t_{PV} 0-6000 = Time in seconds
35	Air flow monitoring during pre-purge 0 = Off 1 = With safety shut-down 2 = With fault lock-out
36	Pre-ventilation time t_{VL} 0-250 = Time in seconds
39	Post-ventilation time t_{NL} 0-60 = Time in seconds

Parameter	
No.	Name Value
40	Capacity control 1 = IC 20 2 = IC 40 3 = RBW 5 = Air valve
41	Running time selection 0 = Off; position check 1 = On; for min./max. capacity 2 = On; for maximum capacity 3 = On; for minimum capacity
42	Running time 0-250 = Time in seconds
43	Low fire over-run 0 = Off 1 = Up to minimum capacity
44	Controller enable signal delay time t_{RF} 0-250 = Time in seconds
48	Air actuator control 0 = Opens on external activation 1 = Opens with valve V1 (1 st stage) 2 = Opens with valve V2 (2 nd stage) 3 = Controller enable after operating signal/in standby 4 = Opens with V4 burner
49	Air actuator on start-up can be activated externally 0 = Cannot be activated 1 = Can be activated externally
50	Air actuator in the event of fault 0 = Cannot be activated 1 = Can be activated externally
51	Valve proving system 0 = Off 1 = Tightness test before start-up 2 = Tightness test after shut-down 3 = Tightness test before start-up and after shut-down 4 = Proof of closure function
52	Relief valve (VPS) 2 = V2 3 = V3
56	Measurement time for V_{D1} 0-3600 = Time in seconds
59	Valve opening time 1 t_{L1} 2-25 = Time in seconds
61	Minimum operating time t_B 0-250 = Time in seconds
62	Minimum pause time t_{MP} 0-3600 = Time in seconds
63	Switch-on delay time t_E 0-250 = Time in seconds
67	Operating time in Manual mode 0 = Unlimited 1 = 5 minutes
68	Function of terminal 50 0 = Off 23 = Purge with Low signal 24 = Purge with High signal

Parameter	
No.	Name Value
69	Function of terminal 51 0 = Off 8 = AND gating with emergency stop input (terminal 46) 9 = AND gating with air pressure switch input (terminal 47) 10 = AND gating with purge pressure switch input (terminal 48) 11 = AND gating with Gas max. input (terminal 50) 12 = AND gating with Gas min. input (terminal 49) 13 = IC 40/RBW purge position feedback
70	Function of terminal 65 0 = Off 8 = AND gating with emergency stop input (terminal 46) 9 = AND gating with air pressure switch input (terminal 47) 10 = AND gating with purge pressure switch input (terminal 48)
71	Function of terminal 66 0 = Off 8 = AND gating with emergency stop input (terminal 46) 9 = AND gating with air pressure switch input (terminal 47) 10 = AND gating with purge pressure switch input (terminal 48) 20 = LDS ignition position check
72	Function of terminal 67 0 = Off 8 = AND gating with emergency stop input (terminal 46) 9 = AND gating with air pressure switch input (terminal 47) 10 = AND gating with purge pressure switch input (terminal 48) 21 = Multi-flame control (MFC) start-up conditions
73	Function of terminal 68 0 = Off 8 = AND gating with emergency stop input (terminal 46) 9 = AND gating with air pressure switch input (terminal 47) 10 = AND gating with purge pressure switch input (terminal 48) 22 = Multi-flame control (MFC) start-up conditions
75	Capacity control (bus) 0 = Off 1 = MIN. to MAX. capacity; standby in position for MIN. capacity 2 = MIN. to MAX. capacity; standby in CLOSED position 3 = IGNITION to MAX. capacity; standby in CLOSED position 4 = MIN. to MAX. capacity; standby in position for MIN. capacity; burner quick start 5 = IGNITION to MAX. capacity; standby in CLOSED position; burner quick start

Parameter	
No.	Name Value
77	Password 0000-9999
78	Burner application 0 = Burner 1 1 = Burner 1 with pilot gas 2 = Burner 1 & burner 2 3 = Br. 1 & Br. 2 with pilot gas 4 = Two-stage burner 1 5 = Br. 1 & two-stage br. 2 11 = menox 1/0 and burner 1/0 12 = menox 1/0 and burner L/H/O 13 = menox 1/0 with 2 gas paths 14 = menox L/H/O with 2 gas paths
79	Pilot burner 0 = With shut-down 1 = Continuous operation
80	Fieldbus communication 0 = Off 1 = With address check 2 = No address check
94	Safety time 1 t_{SA1} 2, 3, 5, 10 = Time in seconds
95	Flame proving period 1 t_{FS1} 0-20 = Time in seconds
96	Safety time 2 t_{SA2} 2, 3, 5, 10 = Time in seconds
97	Flame proving period 2 t_{FS2} 0-20 = Time in seconds

13 LEGEND

Symbol	Description
	Ready for operation
	Safety interlocks (limits)
	Controlled air flow
	Remote reset
	Gas valve
	Air valve
	Air/gas ratio control valve
	Burner
	Purge
	External air valve control
	Burner operating signal
	Fault signal

Symbol	Description
	BCU start-up signal
	Input for high temperature operation
	Pressure switch for tightness control (TC)
	Pressure switch for maximum pressure
	Pressure switch for minimum pressure
	Differential pressure switch
	Actuator with butterfly valve
	Valve with proof of closure switch
	Three-point step switch
	Input/Output, safety circuit
TC	Tightness control
$p_u/2$	Half of the inlet pressure
p_u	Inlet pressure
p_d	Outlet pressure
V_{p1}	Test volume
I_N	Current consumption of sensor/ contactor
t_L	Tightness control opening time
t_M	Measurement time during tightness test
t_P	Tightness control test period (= $2 \times t_L + 2 \times t_M$)
t_{FS}	Flame proving period
t_{MP}	Minimum pause time
t_{NL}	Over-run time
t_{SA}	Safety time on start-up
t_{SB}	Safety time during operation
t_{VZ}	Pre-ignition time
t_{PV}	Pre-purge time
t_{RF}	Controller enable signal delay time

14 TECHNICAL DATA

14.1 Ambient conditions

Avoid direct sunlight or radiation from red-hot surfaces on the unit.

Avoid corrosive influences, e.g. salty ambient air or SO₂.

The unit may only be stored/installed in enclosed rooms/buildings.

This unit is not suitable for cleaning with a high-pressure cleaner and/or cleaning products.

Ambient temperature:

-20 to +60°C (-4 to +140°F),
no condensation permitted.

Enclosure: IP 20 pursuant to IEC 529.

Installation location: min. IP 54 (for installation in a control cabinet).

Permitted operating altitude: < 2000 m AMSL.

14.2 Mechanical data

Weight: 0.7 kg.

Dimensions (W x H x D): 102 x 115 x 112 mm.

Connections:

Screw terminals:

nominal cross-section 2.5 mm²,
wire cross-section (rigid) min. 0.2 mm²,
wire cross-section (rigid) max. 2.5 mm²,
wire cross-section AWG min. 24,
wire cross-section AWG max. 12.

Spring force terminals:

nominal cross-section 2 x 1.5 mm²,
wire cross-section min. 0.2 mm²,
wire cross-section AWG min. 24,
wire cross-section AWG max. 16,
wire cross-section max. 1.5 mm²,
rated current 10 A (8 A UL), to be observed in case of daisy chain.

14.3 Electrical data

Mains voltage:

BCU..Q: 120 V AC, -15/+10%, 50/60 Hz, ±5%,
BCU..W: 230 V AC, -15/+10%, 50/60 Hz, ±5%,
for grounded mains.

Flame control:

with UV sensor or flame rod.

For intermittent or continuous operation.

Flame signal current:

ionization control: 1–25 µA,

UV control: 1–35 µA.

Ionization/UV cable:

max. 100 m (328 ft).

Contact rating:

Valve outputs V1, V2, V3 and V4 (terminals 13, 14, 15 and 57):

max. 1 A each, $\cos \varphi \geq 0.6$.

Actuator outputs (terminals 53, 54 and 55):

max. 1 A each, $\cos \varphi = 1$.

Air valve output (terminal 10):

max. 1 A, $\cos \varphi = 1$.

Ignition transformer (terminal 9):

max. 2 A.

Total current for the simultaneous activation of the valve outputs (terminals 13, 14, 15, 57), of the ignition transformer (terminal 9) and of the actuator (terminals 53, 54, 55):

max. 2.5 A.

Signalling contact for operating and fault signals:

max. 1 A (external fuse required).

Number of operating cycles:

The fail-safe outputs (valve outputs V1, V2, V3 and V4) are monitored for correct functioning and are thus not subject to a max. number of operating cycles.

Control actuator (terminals 53, 54 and 55):

max. 1,000,000,

signalling contact for operating signals:

max. 1,000,000,

signalling contact for fault signals:

max. 10,000,

On/Off button:

max. 10,000,

Reset/Information button:

max. 10,000.

Input voltage of signal inputs:

Rated value	120 V AC	230 V AC
Signal "1"	80–132 V	160–253 V
Signal "0"	0–20 V	0–40 V

Signal input current:

Signal "1"	max. 5 mA
------------	-----------

Fuses, replaceable, F1: T 3.15A H,

F2: T 2A H, pursuant to IEC 60127-2/5.

14.4 Designed lifetime

This information on the designed lifetime is based on using the product in accordance with these operating instructions. Once the designed lifetime has been reached, safety-relevant products must be replaced. Designed lifetime (based on date of manufacture) in accordance with EN 230 and EN 298 for BCU: 20 years. You can find further explanations in the applicable rules and regulations and on the afecor website (www.afecor.org).

This procedure applies to heating systems. For thermoprocessing equipment, observe local regulations.

15 LOGISTICS

Transport

Protect the unit from external forces (blows, shocks, vibration).

Transport temperature: see page 27 (14 Technical data).

Transport is subject to the ambient conditions described.

Report any transport damage on the unit or packaging without delay.

Check that the delivery is complete.

Storage

Storage temperature: see page 27 (14 Technical data).

Storage is subject to the ambient conditions described. Storage time: 6 months in the original packaging before using for the first time. If stored for longer than this, the overall service life will be reduced by the corresponding amount of extra storage time.

16 ACCESSORIES

Spare parts, see www.partdetective.de.

16.1 BCSoft4

The current software can be downloaded from our Internet site at www.docuthek.com. To do so, you need to register in the DOCUTHEK.

16.2 Opto-adaptor PCO 200

Including BCSoft CD-ROM,
Order No.: 74960625.

16.3 Stickers for labelling

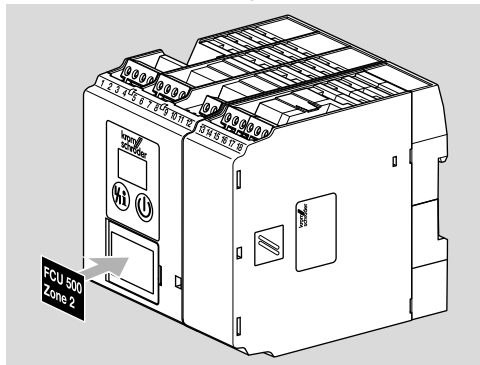

For printing with laser printers, plotters or engraving machines, 27 × 18 mm or 28 × 17.5 mm. Colour: silver.

16.4 Connection plug set

For wiring the BCU 5xx.

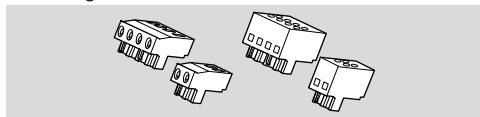

Connection plugs with screw terminals for BCU 5xx..K1

Order No.: 74923998.

Connection plugs with spring force terminals for BCU 5xx..K2

Order No.: 74924000.

16.5 OCU

Operator-control unit for installation in the control cabinet door. The program status or fault messages can be read on the OCU. In Manual mode, the OCU can be used to proceed through the sequence of operating steps.

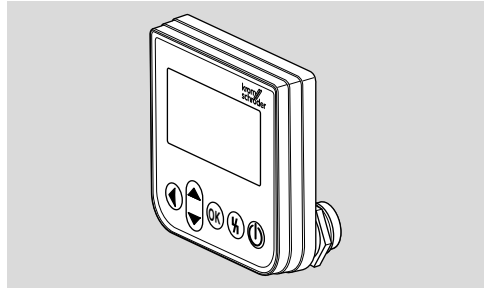

OCU 500-1,

switchable display: D, GB, F, NL, E, I,

Order No. 84327030,

OCU 500-2,

switchable display: GB, DK, S, N, TR, P,

Order No. 84327031,

OCU 500-3,

switchable display: GB, USA, E, P (BR), F,

Order No. 84327032,

OCU 500-4,

switchable display: GB, RUS, PL, HR, RO, CZ,

Order No. 84327033.

17 CERTIFICATION

17.1 Certificate download

Certificates – see www.docuthek.com

17.2 Declaration of conformity



We, the manufacturer, hereby declare that the products BCU 5xx comply with the requirements of the listed Directives and Standards.

Directives:

- 2014/35/EU – LVD
- 2014/30/EU – EMC

Regulation:

- (EU) 2016/426 – GAR

Standards:

- EN 298:2012
- EN 1643:2014
- EN 61508:2010, suitable for SIL 3

The relevant product corresponds to the tested type sample.

The production is subject to the surveillance procedure pursuant to Regulation (EU) 2016/426 Annex III paragraph 3.

Elster GmbH

17.3 FM approved



Factory Mutual (FM) Research Class:

7610 “Combustion Safeguards and Flame Sensing Systems”.

Designed for applications pursuant to NFPA 86.

17.4 ANSI/CSA approved



Canadian Standards Association –
ANSI Z21.20 and CSA 22.2

17.5 UKCA certified



Gas Appliances (Product Safety and Metrology etc. (Amendment etc.) (EU Exit) Regulations 2019)

BS EN 298:2012

BS EN 1643:2014

BS EN 14459:2007

17.6 Eurasian Customs Union



The products BCU 560, BCU 565, BCU 580 meet the technical specifications of the Eurasian Customs Union.

17.7 REACH Regulation

The device contains substances of very high concern which are listed in the Candidate List of the European REACH Regulation No. 1907/2006. See Reach list HTS at www.docuthek.com.

17.8 China RoHS

Directive on the restriction of the use of hazardous substances (RoHS) in China. Scan of the Disclosure Table China RoHS2, see certificates at www.docuthek.com.

18 DISPOSAL

Devices with electronic components:

WEEE Directive 2012/19/EU – Waste Electrical and Electronic Equipment Directive



At the end of the product life (number of operating cycles reached), dispose of the packaging and product in a corresponding recycling centre. Do not dispose of the unit with the usual domestic refuse. Do not burn the product. On request, old units may be returned carriage paid to the manufacturer in accordance with the relevant waste legislation requirements.

FOR MORE INFORMATION

The Honeywell Thermal Solutions family of products includes Honeywell Combustion Safety, Eclipse, Exothermics, Hauck, Kromschroder and Maxon. To learn more about our products, visit ThermalSolutions.honeywell.com or contact your Honeywell Sales Engineer.

Elster GmbH
Strotheweg 1, D-49504 Lotte
T +49 541 1214-0
hts.lotte@honeywell.com
www.kromschroeder.com

Global centralized service deployment coordination:
T +49 541 1214-365 or -555
hts.service.germany@honeywell.com

Translation from the German
© 2022 Elster GmbH

Honeywell
krom
schröder