

Pressure switches for air DL 1–50E

OPERATING INSTRUCTIONS

Cert. Version 05.18 · Edition 01.21 · EN · 34425502



1 SAFETY

1.1 Please read and keep in a safe place



Please read through these instructions carefully before installing or operating. Following the installation, pass the instructions on to the operator. This unit must be installed and commissioned in accordance with the regulations and standards in force. These instructions can also be found at www.docuthek.com.

1.2 Explanation of symbols

1, 2, 3, a, b, c = Action

→ = Instruction

1.3 Liability

We will not be held liable for damage resulting from non-observance of the instructions and non-compliant use.

1.4 Safety instructions

Information that is relevant for safety is indicated in the instructions as follows:

⚠ DANGER

Indicates potentially fatal situations.

⚠ WARNING

Indicates possible danger to life and limb.

⚠ CAUTION

Indicates possible material damage.

All interventions may only be carried out by qualified gas technicians. Electrical interventions may only be carried out by qualified electricians.

1.5 Conversion, spare parts

All technical changes are prohibited. Only use OEM spare parts.

CONTENTS

1 Safety	1
2 Checking the usage	2
3 Installation	2
4 Wiring	3
5 Adjustment	4
6 Function check	4
7 Accessories	4
8 Technical data	5
9 Designed lifetime	5
10 Certification	6
11 Logistics	6
12 Disposal	6

2 CHECKING THE USAGE

DL 1–50E

For monitoring positive, negative or differential pressures of air, flue gas or other non-aggressive gases. This function is only guaranteed when used within the specified limits – see page 5 (8 Technical data). Any other use is considered as non-compliant.

2.1 Type code DL 1–50E

DL	Pressure switch for air
1	Adjusting range 0.2–1 mbar
3	Adjusting range 0.2–3 mbar
5	Adjusting range 0.4–5 mbar
10	Adjusting range 1.0–10 mbar
50	Adjusting range 2.5–50 mbar
E	With tube connection, adjusting screw
G	With gold contacts
-1	AMP plug connection
P	With test tapping point
W	Z-angle bracket

2.2 Type code DL 1–50ET

DL	Pressure switch for air
1	Adjusting range 0.08–0.4 "WC (0.2–1 mbar)
3	Adjusting range 0.12–1.2 "WC (0.3–3 mbar)
5	Adjusting range 0.2–2 "WC (0.5–5 mbar)
10	Adjusting range 0.4–4 "WC (1–10 mbar)
50	Adjusting range 1–20 "WC (2.5–50 mbar)
E	With tube connection, adjusting screw
T	T-product
-1	AMP plug connection (UR recognized)

2.3 Part designations

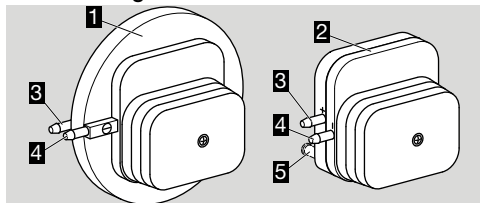

- 1 DL 1–3E
- 2 DL 5–50E
- 3 Positive pressure connection
- 4 Negative pressure connection
- 5 Test tapping point on DL 5–50E..P

2.4 Type label

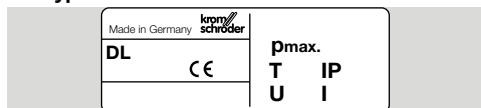

Max. inlet pressure $p_{max.}$ = withstand pressure, mains voltage, installation position, switching point p_S , ambient temperature, enclosure: see type label.

3 INSTALLATION

⚠ CAUTION

Please observe the following to ensure that the unit is not damaged during installation:

- Dropping the device can cause permanent damage. In this event, replace the entire device and associated modules before use.
- Note the max. medium and ambient temperatures, see page 5 (8 Technical data).
- Condensation must not be allowed to get into the housing.
- Protect the connections against dirt or moisture in the medium to be measured or the surrounding air. If necessary, install a filter.
- In the case of an uneven mounting surface, secure the pressure switch to the mounting plate or air duct with only two screws on the same side in order to avoid subjecting the pressure switch to mechanical stress.
- Vapours containing silicone can adversely affect the functioning of electrical contacts. When using silicone tubes, only use silicone tubes which have been sufficiently cured.
- In the case of high humidity, we recommend using a pressure switch with gold contact due to its higher resistance to corrosion. Closed-circuit current monitoring is recommended under difficult operating conditions.

→ Installation position – see type label. If installed in another position, the switching point p_S will change.

$p_S = SK$	SK + 18 Pa [+ 0,071 "WC]	SK - 18 Pa [- 0,071 "WC]
DL 1E, DL 3E		
DL 5E, DL 10E, DL 50E		

→ Adjustment of switching point p_S , see type label. Example of DL 5ET: $p_S = 100$ Pa, installation upside down, 100 Pa - 18 Pa = 82 Pa.

1 Install the DL using screws.

The following screw specifications apply when using a (1 mm thick) mounting plate and self-tapping screws for plastic:

	Hole dia./depth	Screw dia./length
DL 1–3E	Ø 2.7 x 8 mm	Ø 3 x 8 mm
DL 1–3E	Ø 3.5 x 8 mm	Ø 4 x 8 mm
DL 5–50E	Ø 3 x 16 mm	Ø 3.5 x 16 mm
DL 5–50E	Ø 4.2	M4

→ Angle bracket, see accessories.

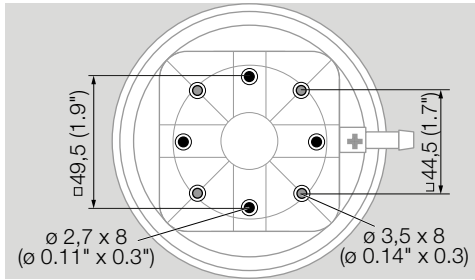

DL 1-3E

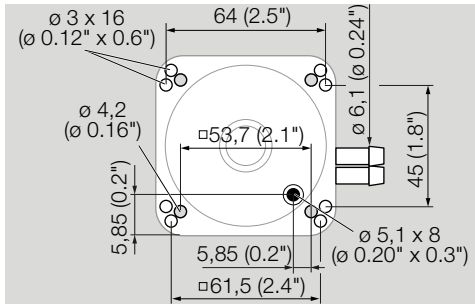

DL 5-50E-1P

2 Connect the flexible tubes.

→ Tube connection \varnothing 6 mm (0.236").

→ Max. inlet pressure $p_{max.}$, see page 4 (5.1 Adjusting range)

Positive pressure

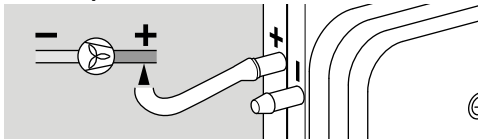

Negative pressure

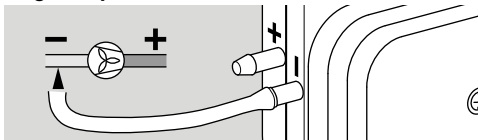

Differential pressure

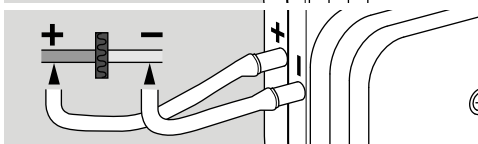
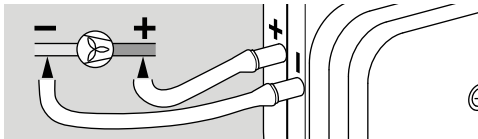

3.1 Test tapping point on DL 5-50E-1P

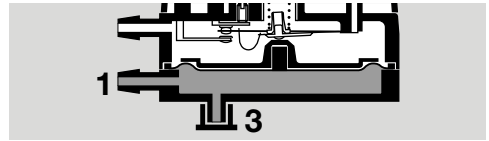

A measuring instrument can be connected to port **3** or the boiler pressure can be queried.

If port **3** is used for pressure measurement, the sealing cap must be transferred from port **3** to **1**.

4 WIRING

→ If the pressure switch has switched a voltage > 24 V (> 30 V) and a current > 0.1 A at $\cos \varphi = 1$ or > 0.05 A at $\cos \varphi = 0.6$ once, the gold plating on the contacts will have been burnt through. It can then only be operated at this power rating or higher power rating.

CAUTION

– To ensure that the DL is not damaged during operation, note the switching capacity, see page 5 (8 Technical data).

In the case of low switching capacities, such as 24 V, 8 mA, for example, we recommend using an RC module (22 Ω , 1 μ F) in air containing silicone or oil.

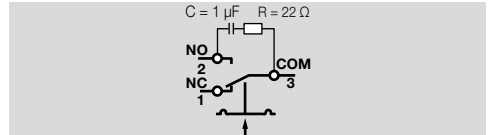

1 Disconnect the system from the electrical power supply.

→ Use AMP plugs for wiring.

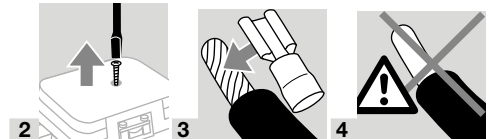

→ The cable must be guided under the strain relief facility.

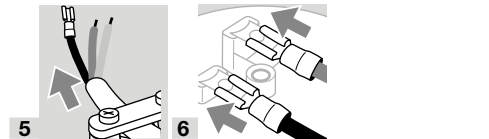

7 Wire as shown on the connection diagram.

→ Contacts **3** and **2** close when subject to increasing pressure. Contacts **1** and **3** close when subject to falling pressure. With the NO contact, the NC contact is omitted.

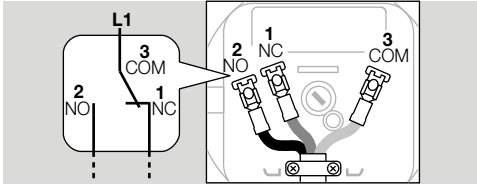

8 Reinstall the housing cover after wiring (see page 5 (8 Technical data) for tightening torque) or continue with the setting work.

5 ADJUSTMENT

The switching point p_S can be adjusted using the adjusting screw.

- 1 Disconnect the system from the electrical power supply.
- 2 Unscrew the housing cover.
- 3 Carefully remove the AMP plugs from the contacts.
- 4 Connect an ohmmeter.

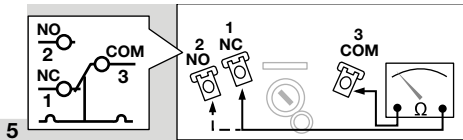

6 Adjust switching point p_S using the adjusting screw, see tables in the section entitled "Adjusting range".

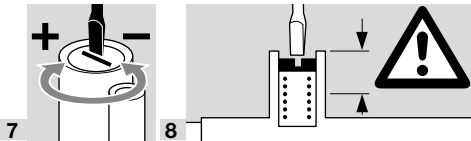

9 Connect a pressure gauge.

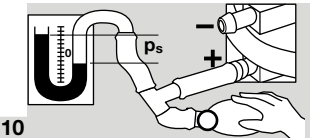

- 11 Apply pressure. In doing so, monitor the switching point on the ohmmeter and the pressure gauge.
- 12 If the DL 1–50E does not trip at the desired switching point, correct the adjusting range using the hand wheel. Relieve the pressure and repeat the process.
- 13 After successfully completing the settings, slide the AMP plugs back onto the contacts and install the housing cover (see page 5 (8 Technical data) for tightening torque).

5.1 Adjusting range

	Adjusting range ¹⁾ [mbar]		Max. inlet pressure ²⁾ [mbar]	Mean switching differential ³⁾ [mbar]	
	min.	max.		min.	max.
DL 1E	0.2	1	50	0.1	0.15
DL 3E	0.3	3	50	0.2	0.3
DL 5E	0.4	5	300	0.25	0.4
DL 5ET	0.5	5	300	0.25	0.4
DL 10E	1	10	300	0.3	0.4
DL 50E	2.5	50	300	0.5	1.3

	Adjusting range ¹⁾ ["WC]		Max. inlet pressure ²⁾ ["WC]	Mean switching differential ³⁾ ["WC]	
	min.	max.		min.	max.
DL 1ET	0.08	0.4	20	0.04	0.06
DL 3ET	0.12	1.2	20	0.08	0.12
DL 5ET	0.2	2	117	0.01	0.16
DL 10ET	0.4	4	117	0.12	0.16
DL 50ET	1	20	117	0.2	0.5

¹⁾ Switching point adjusting tolerance: $\pm 15\%$ or by agreement.

²⁾ Max. inlet pressure = withstand pressure.

³⁾ Mean switching differential at min. and max. setting.

Type	Deviation from the switching point during testing pursuant to EN 1854 Air pressure switches
DL 1E, DL 1ET	$\pm 15\%$ or ± 5 Pa [± 0.02 "WC]
DL 3E, DL 3ET	$\pm 15\%$ or ± 6 Pa [± 0.02 "WC]
DL 5E–50E, DL 5ET–50ET	$\pm 15\%$

6 FUNCTION CHECK

We recommend a function check once a year.

7 ACCESSORIES

7.1 Z-angle bracket

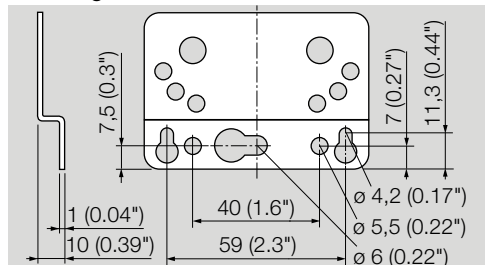

For DL 5–50E: Order No. 74916158.

For DL 1–3E: Order No. 74913661.

7.2 DL 1–50E: grommet

Grommet for enclosure IP 42.

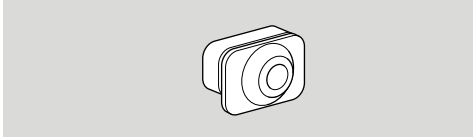

Order No.: 34328197

Grommet for enclosure IP 44.

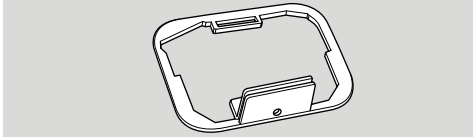

Order No.: 34330703

7.3 Tube set

To be used with air only.

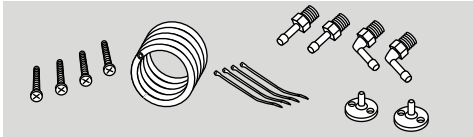

Tube set with 2 m PVC tube, 2 duct connection flanges with screws, R 1/4 and R 1/8 connecting nipples.
Order No.: 74912952.

7.4 Tube set

To be used with air only.

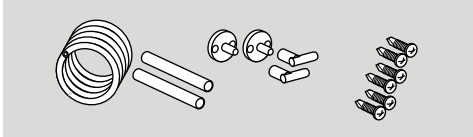

With 2 m PVC tube, 2 duct connection flanges with screws, 2 x 90 mm extensions, 2 angle connectors for DL

Order No.: 74919272.

8 TECHNICAL DATA

Micro switch to EN 61058-1.

Gas types: air or flue gas, no flammable gases, no aggressive gases.

Icing, condensation and dew in and on the unit are not permitted.

Safety class II to VDE 0106-1.

This unit is not suitable for cleaning with a high-pressure cleaner and/or cleaning products.

8.1 Pressure switch with NBR diaphragm

Long-term use in the upper ambient temperature range accelerates the ageing of the elastomer materials and reduces the service life (please contact manufacturer). Ozone concentrations exceeding 200 µg/m³ accelerate the ageing of elastomer materials and reduce the service life.

Ambient conditions

Enclosure to IEC 60529:

IP 10 = any installation position,

IP 21 = electrical connection from below,

IP 42/44 = with cable grommet, see accessories.

Permitted ambient temperature in operation:

-20 to +80°C (-4 to +176°F),

DL..T: -40 to +60°C (-40 to +140°F).

Storage and transport temperatures:

-20 to +40°C (-4 to +104°F).

Mechanical data

Medium temperature = ambient temperature.

Max. inlet pressure p_{max} = withstand pressure, switching differential, see page 4 (5.1 Adjusting range).

Diaphragm pressure switch, NBR, silicone-free.

Housing: glass fibre reinforced PBT plastic with low gas release.

DL 1E, DL 3E: 145 g (5.1 oz),

DL 5E–50E: 115 g (4 oz).

Recommended tightening torque:

Component	Tightening torque [Ncm]
Cover screws	50
Strain relief facility	60

8.2 Switching capacity

	U	I (cos φ = 1)	I (cos φ = 0.6)
DL	24–250 V AC	0.05–5 A	0.05–1 A
DL..G	5–250 V AC	0.01–5 A	0.01–1 A
DL..G	5–48 V DC	0.01–1 A	0.01–1 A
DL..T	30–240 V AC	5 A	0.5 A
DL..TG	< 30 V AC/ DC	0.1 A	0.05 A

Contact gap < 3 mm (µ).

If the pressure switch has switched a voltage > 24 V (> 30 V) and a current > 0.1 A at cos φ = 1 or > 0.05 A at cos φ = 0.6 once, the gold plating on the contacts will have been burnt through. It can then only be operated at this power rating or higher power rating.

9 DESIGNED LIFETIME

This information on the designed lifetime is based on using the product in accordance with these operating instructions. Once the designed lifetime has been reached, safety-relevant products must be replaced. Designed lifetime (based on date of manufacture) in accordance with EN 13611, EN 1854 for DL 1–50E: 10 years.

You can find further explanations in the applicable rules and regulations and on the afecor website (www.afecor.org).

This procedure applies to heating systems. For thermoprocessing equipment, observe local regulations.

10 CERTIFICATION

Declaration of conformity



We, the manufacturer, hereby declare that the products DL 1–50E with product ID No. CE- 0085AP0466 comply with the requirements of the listed Directives and Standards.

Directives:

- 2014/35/EU – LVD
- 2014/30/EU – EMC
- 2011/65/EU – RoHS II
- 2015/863/EU – RoHS III

Regulation:

- (EU) 2016/426 – GAR

Standards:

- EN 1854:2010

The relevant product corresponds to the tested type sample.

The production is subject to the surveillance procedure pursuant to Regulation (EU) 2016/426 Annex III paragraph 3.

Elster GmbH

Scan of the Declaration of conformity (D, GB) – see www.docuthek.com

10.1 FM and AGA approval, UR listing, Eurasian Customs Union, RoHS compliant



10.2 REACH Regulation

The device contains substances of very high concern which are listed in the Candidate List of the European REACH Regulation No. 1907/2006. See Reach list HTS at www.docuthek.com.

10.3 China RoHS

Directive on the restriction of the use of hazardous substances (RoHS) in China. Scan of the Disclosure Table China RoHS2, see certificates at www.docuthek.com.

FOR MORE INFORMATION

The Honeywell Thermal Solutions family of products includes Honeywell Combustion Safety, Eclipse, Exothermics, Hauck, Kromschroder and Maxon. To learn more about our products, visit ThermalSolutions.honeywell.com or contact your Honeywell Sales Engineer.

Elster GmbH
Strotheweg 1, D-49504 Lotte
T +49 541 1214-0
hts.lotte@honeywell.com
www.kromschroeder.com

Global centralized service deployment coordination:
T +49 541 1214-365 or -555
hts.service.germany@honeywell.com

11 LOGISTICS

Transport

Protect the unit from external forces (blows, shocks, vibration).

Transport temperature: see page 5 (8 Technical data).

Transport is subject to the ambient conditions described.

Report any transport damage on the unit or packaging without delay.

Check that the delivery is complete.

Storage

Storage temperature: see page 5 (8 Technical data).

Storage is subject to the ambient conditions described.

Storage time: 6 months in the original packaging before using for the first time. If stored for longer than this, the overall service life will be reduced by the corresponding amount of extra storage time.

12 DISPOSAL

Devices with electronic components:

WEEE Directive 2012/19/EU – Waste Electrical and Electronic Equipment Directive



At the end of the product life (number of operating cycles reached), dispose of the packaging and product in a corresponding recycling centre. Do not dispose of the unit with the usual domestic refuse. Do not burn the product. On request, old units may be returned carriage paid to the manufacturer in accordance with the relevant waste legislation requirements.

Honeywell
kromschroder

Translation from the German
© 2021 Elster GmbH