

DE, EN, IT, ES, SR, CS, RO
→ www.docuthek.com

Operating instructions

Electronic index EI6/EI7



themis®

Contents

Electronic index EI6/EI7 1

Contents 1

Safety 1

Checking the usage 2

Supplier guidance 2

Installation 3

Operating the electronic index 3

Navigating within the menu 3

Service mode 6

Establishing an optical communications link 8

Setting the index parameters 8

Changing the battery 8

Changing the SIM card 9

Electrical pulse output (only for EI7) 9

Establishing wireless communication 9

Releasing the valve 10

Check test 10

Assistance in the event of malfunction 14

Maintenance 14

Accessories 14

Spare parts 14

Technical data 14

Logistics 15

Data security 15

Contact 16

Safety

Please read and keep in a safe place



Please read through these instructions carefully before installing or operating. Following the installation, pass the instructions on to the operator. This unit must be installed and commissioned in accordance with the regulations and standards in force. These instructions can also be found at www.docuthek.com.

Explanation of symbols

■, 1, 2, 3... = Action
> = Instruction

Liability

We will not be held liable for damage resulting from non-observance of the instructions and non-compliant use.

Safety instructions

Information that is relevant for safety is indicated in the instructions as follows:

⚠ DANGER

Indicates potentially fatal situations.

⚠ WARNING

Indicates possible danger to life and limb.

! CAUTION

Indicates possible material damage.

All interventions may only be carried out by qualified gas technicians. Electrical interventions may only be carried out by qualified electricians.

Conversion, spare parts

All technical changes are prohibited. Only use OEM spare parts.

Changes to edition 03.20

The following chapters have been changed:

- Checking the usage
- Operating the electronic index
- Navigating within the menu
- Service mode
- Establishing an optical communications link
- Electrical pulse output
- Establishing wireless communication
- Accessories
- Spare parts
- Technical data

Checking the usage

Electronic index EI6/EI7 for diaphragm gas meters BK...E, BK...ETe and BK...ETeB

The electronic index EI6/EI7 displays the following volume depending on the meter type:

BK...E	non-converted volume
BK...ETe	volume converted to the base temperature
BK...ETeB	volume converted to the base temperature and base pressure

It can be used for reading out absolute consumption values and for retrieving consumption data for the various tariffs.

Gas meter BK...ETeB must only be operated with an inlet pressure the average of which over time corresponds to the assumed pressure p_{sp} , see page 14 (Technical data).

The national statutory regulations must be observed. This function is only guaranteed when used within the specified limits – see page 14 (Technical data). Any other use is considered as non-compliant.

Type code

Code	Description
EI	Electronic index
6.06	Wireless technology: GPRS, cyclic meter volume V: up to 1.2 dm ³ , connector spacing: up to 130 mm
6.07	Wireless technology: GPRS, for all other meter sizes
6.14	Wireless technology: NB-IoT, cyclic meter volume V: up to 1.2 dm ³ , connector spacing: up to 130 mm
6.15	Wireless technology: NB-IoT, for all other meter sizes
6.16	similar to EI6.14, but with eSIM and 3-pole battery connector
6.17	similar to EI6.15, but with eSIM and 3-pole battery connector
7.00	Wireless technology: NB-IoT & GPRS, for meter sizes G10 – G100

Part designations

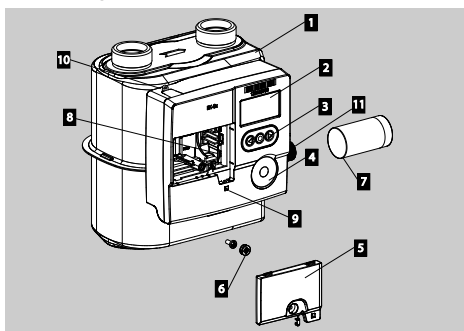

- 1 Gas meter with electronic index
- 2 Display
- 3 User keys
- 4 Opto-adaptor interface
- 5 Battery cover
- 6 Installation seal/Screw locking cap
- 7 Battery
- 8 SIM card
- 9 Opening for additional sealing of the battery cover
- 10 Lug for sealing the connections
- 11 Pulse output (EI7 only)

- 5 Battery cover
- 6 Installation seal/Screw locking cap
- 7 Battery
- 8 SIM card
- 9 Opening for additional sealing of the battery cover
- 10 Lug for sealing the connections
- 11 Pulse output (EI7 only)

Type label/Index plate

Please quote for all enquiries:

- ▷ The manufacturer's serial number **S/N** can be found at the bottom of the type label.
- ▷ Index version EI... (next to the serial number).
- ▷ For gas meters BK...ETeB, “ p_{sp} ” and “ p_b ” are also specified.

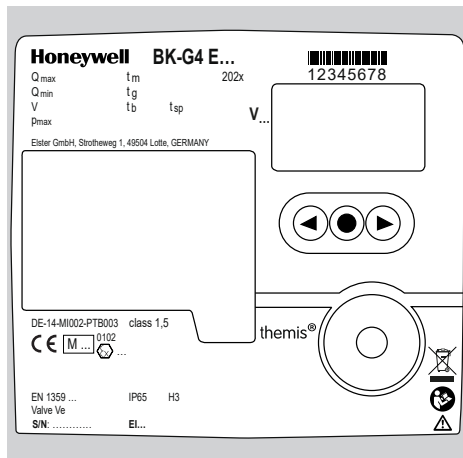

ATEX

- ▷ The electronic index is suitable for use in potentially explosive atmospheres. For the exact use (zone), see ATEX sticker on the diaphragm gas meter or see the operating instructions for diaphragm gas meters BK-G1.6 to BK-G25 or operating instructions for industrial diaphragm gas meters Type BK-G40... → www.docuthek.com.

Supplier guidance

- ▷ As part of the commissioning process, the energy supplier should ensure that the meter clock is set correctly via a “Set clock” command.
- ▷ Following successful commissioning to the relevant network, it is recommended that, within 7 days, the meter is issued with a new set of security credentials.
- ▷ Prior to meter removal, it is recommended that the energy supplier deletes or overwrites sensitive information on the meter to ensure consumer data protection. As a minimum, this should include deletion of any customer identification information (e.g. Metering Point ID).

Installation

⚠ WARNING

Risk of explosion in explosion-hazard areas!

- The non-metallic housing of the EI7 may generate an ignition-capable level of electrostatic discharge. Therefore, the device shall not be installed in a location where the external conditions are conducive to the build-up of electrostatic charge on such surfaces. This is particularly important if the device is installed in a Zone 0 location. In addition, the device shall only be cleaned with a damp cloth.

Installing the gas meter

- ▷ For installing the gas meter in the pipework, refer to the operating instructions for diaphragm gas meters BK-G1.6 to BK-G25 or operating instructions for industrial diaphragm gas meters Type BK-G40... → www.docuthek.com.

Gas meter with integrated valve

- ▷ If the integrated shut-off valve in the gas meter is closed, it must be released, see page 10 (Releasing the valve).

Operating the electronic index

- ▷ The display on the index is switched off.
- Press any key briefly.

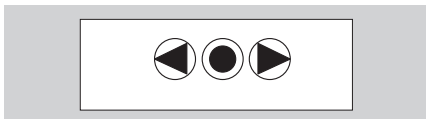

- ▷ 2 LCD pixel test patterns appear in the display. After 1 second, the display switches to the main screen.
- ▷ The left user key is not present on variants.

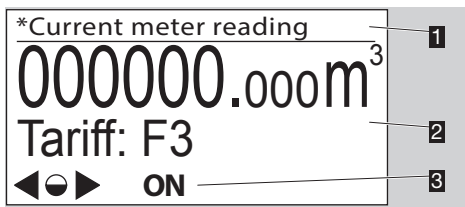

1 Menu area

2 Information area (optional: tariff)

3 Status line (symbols)

- ▷ The **ON/OFF** symbols are only displayed when a valve is integrated in the gas meter.

User keys, selection key and symbols

- ▷ Navigate through the menu with the user keys ►, ◀ and the selection key ●. Note: the right or left arrow key may be missing on some versions.

Symbol	Meaning
►, ◀	Navigate to the left or the right on each level using the user keys.
●	Briefly pressing the selection key selects a sub-menu. Holding the selection key pressed down switches the display back to the higher-level menu.
◐	Briefly pressing the selection key selects a sub-menu.
◑	Holding the selection key pressed down switches the display back to the higher-level menu.
▷, ○, ◁	Keys inactive
(☎)	Radio module or wireless communication active
♀	Radio module or wireless communication inactive
♀=♀	Wireless communication – pairing successful
OFF	Valve/gas flow closed. This symbol is only displayed when a valve is integrated in the gas meter.
ON	Valve/gas flow released. This symbol is only displayed when a valve is integrated in the gas meter.
⚠	Invalid data
⚠	Fault message
🔋	Low battery. This symbol is only displayed when battery power is low.
*	Marking for metrology-relevant data
⚠*	Multiple sensor data invalid

- ▷ In the “Icon definitions” menu, the most important symbols are described briefly.

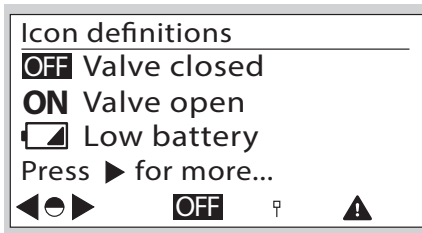

Navigating within the menu

- ▷ The menu is constructed hierarchically.
- ▷ Depending on the configuration, some menu options may be missing.
- ▷ The “Current meter reading” main screen appears when switching on the index.
- ▷ If a different menu is active, the display will automatically change back to the main screen when no user key has been pressed for 30 s, and switches off after a further 30 s.
- ▷ Navigate from the main screen to the various menus, such as “Meter information”, with the user keys ►, ◀.

Menu overview

The display can differ depending on the parameterization or communications unit.

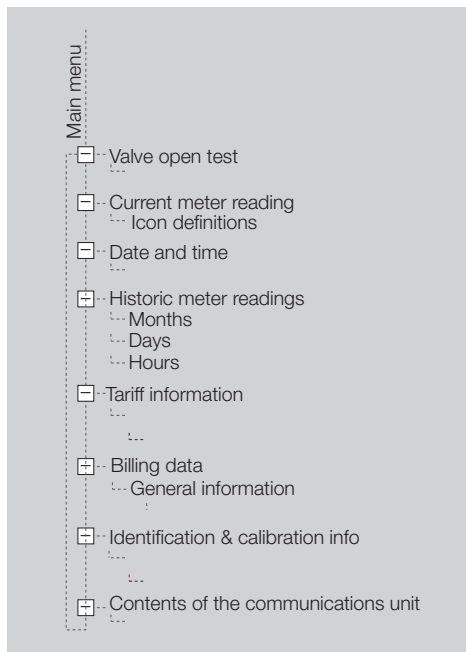

Current meter reading

- ▷ The absolute meter reading and optionally the current tariff are indicated in the main screen.
- ▷ This appears when the index is switched on.
- ▷ Information about the symbols is displayed when pressing the selection key ● and the user keys ►, ◀. Or see page 3 (User keys, selection key and symbols).

Valve open test

- ▷ The "Valve open test" menu option is only displayed if the meter has received a command to open the valve.
- ▷ If the valve was released while the display was switched off, the release note will appear the next time the index is switched on.

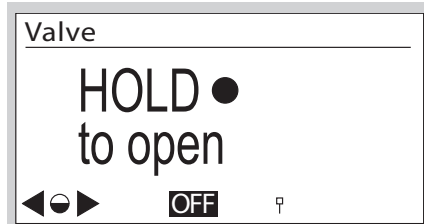

- ▷ The note remains active until the valve has been released, see page 10 (Releasing the valve).
- ▷ If the selection key ● is not pressed, the display will switch back to the main screen after 30 s.

Date and time

- ▷ Information on the date and time display.
- ▷ UTC = coordinated universal time + X = offset for conversion to local time.
- ▷ The local time is supported.
- ▷ Optional summer/winter time changeover.
- ▷ Further information is available from the meter operator.

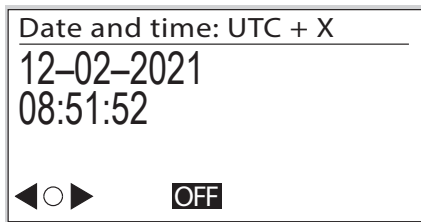

- ▷ The date is given in the format day – month – year.
- ▷ The date format can differ depending on the market.

Historic meter readings

- ▷ Depending on the configuration, this menu may be missing.
- ▷ Consumption data dating as far back as 190 days can be called up.

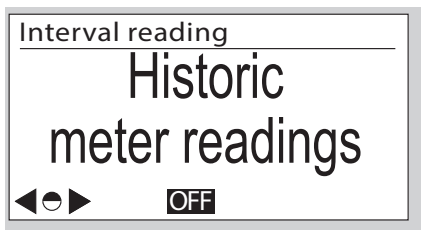

- ▷ By pressing the selection key ●, consumption data are displayed, which are summarized by month, day or hour:

M: month

D: day

H: hour

- ▷ The timeframe is displayed with date and time for the start and end of the period.
- ▷ The meter reading is displayed for the start and end of the period in m³.
- ▷ The consumption V_b for this period is indicated in m³.
- ▷ Example "Daily summary"

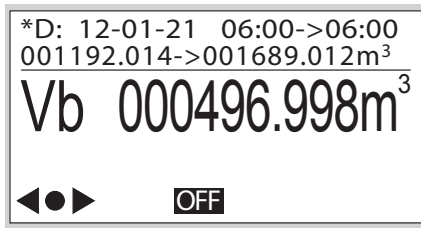

Tariff information (E16 only)

- ▷ This menu contains information on the current tariff program.

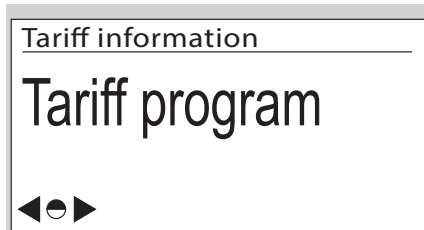

- ▷ By briefly pressing the selection key ●, you can access further information. Here, the active tariff program is displayed, as are the date and time of activation.

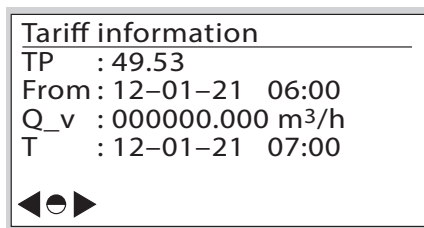

- TP = tariff program
- From = start date
- Q_v = maximum conventional flow rate (Q_{bc_max})
- T = time at which Q_{bc_max} occurred

Billing data (E16 only)

- ▷ This menu contains information on the current consumption in accordance with the tariff.



- ▷ By briefly pressing the selection key ●, you can access further information.

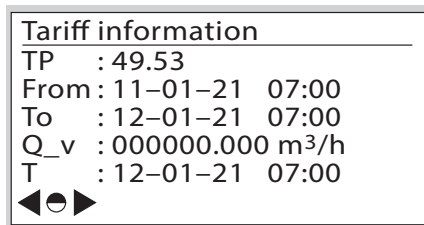

- To = end date

Tariff information

Vb : 000000.015 m³
Ta : 000000.000 m³
T1 : 000000.000 m³
T2 : 000000.000 m³
T3 : 000000.015 m³



Vb = converted volume with reference to the temperature

Ta = volume under faulty measuring conditions

T1–T3 = absolute values from the tariff registers

- ▷ The data are updated hourly.

Identification & calibration info

- ▷ Meter-specific technical data are displayed in sub-menus by pressing the user keys ▶, ◀ and the selection key ●.

Meter information



- ▷ Information about the software is displayed when pressing the user keys ▶, ◀.

Metrological FW info

Ver. : 1.x.yx
CRC : 0x34 12
Build Rel : 22267
Date : 09-02-2021



Ver. = software version

CRC = software checksum

Build Rel = software details

Date = year of manufacture

- ▷ Other screen descriptions (not illustrated):

Calibration information:

Meter calibration parameters Q1 to Q3 (adjustment values Q1 to Q3 for three-point calibration)

Meter properties:

Cyclic meter volume

Transitional flow rate

EN 1359 Reg. No.: NG-4701BM0443 (example)

Environment classes:

Electromagnetic

Mechanical

Firmware traceability

- ▷ Only events which are relevant for the software history are listed in the “Firmware traceability” menu.

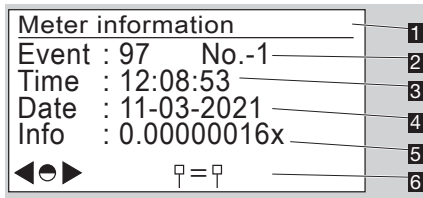
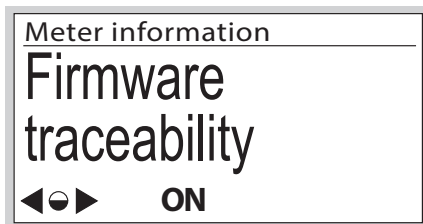

- 1 Menu area
- 2 Event: event which has occurred:
 - 97 Activation date for software update programmed
 - 98 Verification of software update successful
 - 99 Verification of software update failed
 - 100 Activation of software update successful
 - 101 Activation of software update failed
- 3 Time at which the event occurred
- 4 Date on which the event occurred
- 5 Info: additional data
- 6 Navigation symbols

Contents of the communications unit

See page 9 (Establishing wireless communication).

Service mode

Activating Service mode

- 1 Press the selection key ● and hold down.
 - ▷ A pixel will appear in each corner of the display.
- 2 Release the key ● for 2 seconds and then press and hold it again.
- 3 Repeat the process until “Test instructions” appears in the menu area.
 - ▷ Service mode is activated.
 - ▷ For some actions such as programming the index or actuating individual components (e.g. when changing the battery), the user software has to be adapted to the index. Please contact the manufacturer.

Service mode menu overview

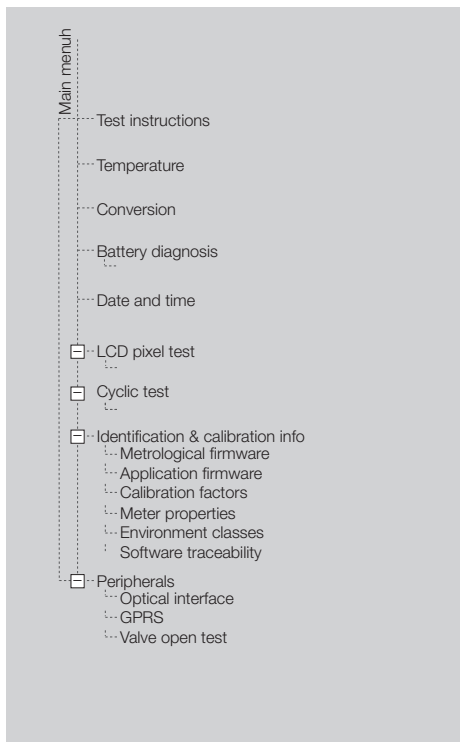

Test instructions

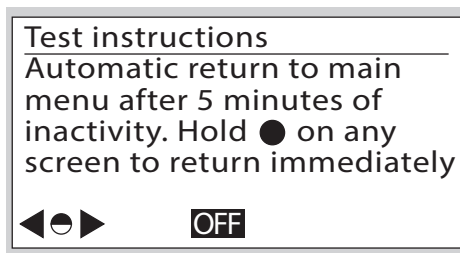

Temperature

- ▷ The current gas temperature is displayed.

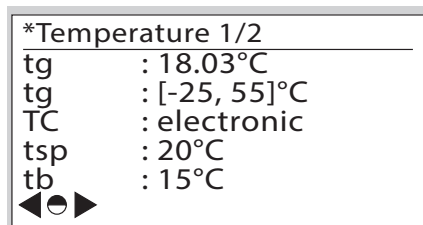

- tg = currently measured gas temperature
- tg [...] = max. allowable gas temperature range [min. value, max. value]

- TC = type of temperature conversion.
Electronic: mathematical conversion to t_b in index
- tsp = specified centre temperature t_{sp} (in accordance with EN 1359)
- tb = base temperature t_b (in accordance with EN 1359)

- ▷ You can display additional temperature information by pressing the selection key .

Temperature 2/2



tg : 18.03°C

tg : [-25, 55]°C

t mean : 22.09°C

t min : 12.85°C

t max : 26.25°C

- t mean = average temperature
- t min = minimum temperature measured
- t max = maximum temperature measured

- ▷ Check test for temperature measurement, see page 10 (Check test).
- ▷ The measured values are updated once per minute.

Conversion

- ▷ Conversion information is displayed.

Conversion



Vb: 0.005m³

Va: 0.006m³

Flow: 0 l/h

tg: 21.16°C

Cf: 0.979090

- Vb = volume at base conditions
- Va = volume under faulty measuring conditions
- Flow = current flow rate
- tg = current temperature
- Cf = conversion factor $C_f = (T_b/T_g)$

Battery diagnosis

- ▷ There is one battery in the index. A second battery can be retrofitted as an option. In addition to the batteries, there is an accumulator which is charged by the batteries.
- ▷ There are four different menus for battery diagnosis.
- ▷ Information about the battery is displayed (display 1/4: main battery, display 2/4: replacement battery).

Main battery 1/4



Install. date : 05-11-2055

Capacity : 19000000 uAh

Charge : 99.999969 %

Use : 0 h

In use : yes

- Install. date = date of installation
- Capacity = initial capacity
- Charge = remaining battery capacity
- Use = time of use in hours
- In use: yes = the battery is in use,
no = the battery is not in use.



- ▷ The next display 3/4 contains data for battery diagnosis.

Batt. diag. 3/4

Vcc : 3.00 V

V(min) : 3.00 V

Status : OK

- Vcc = indicates the current voltage measured on the battery.
- V(min) = indicates the minimum voltage measured on the battery.
- Status = OK: the battery voltage is adequate.
Substitute battery: The battery must be changed within a short time.
Tampering: the battery is not connected.

- ▷ Display 4/4 shows battery consumption.

Consumption counters 4/4

Com -RF: 3 -IR : 6

Vlv -op: 4 -cl : 4

Display: 31

Backgr: 0

- Com-RF = number of wireless connections
- Com-IR = number of connections via the optical interface
- Vlv-op = number of valve openings
- Vlv-cl = number of valve closings
- Display = number of display activations
- Backgr = basic daily consumption

Date and time

- ▷ See page 4 (Date and time).

LCD pixel test

- ▷ A display test can be carried out in this menu.

- 1** Follow the displayed instructions.

- ▷ A test pattern is shown in the display.
- 2** Briefly press the selection key ●.
- ▷ A further test pattern appears in the display.
- 3** Press the selection key and hold down. The display switches to the previous menu.

Cyclic test

- ▷ The accuracy of the meter can be checked using a cyclic test.
- ▷ For more details of the cyclic test, see page 10 (Check test).

GPRS/NB-IoT status

- ▷ The communications data are displayed, see page 9 (Establishing wireless communication).

Identification & calibration info

- ▷ See page 3 (Navigating within the menu).

Establishing an optical communications link

- ▷ Depending on customer requirements, the optical interface can be locked.
- ▷ In order to configure the electronic index for the respective application, the optical communications link must be activated.
- 1** Position the opto-adapter head on the interface provided.

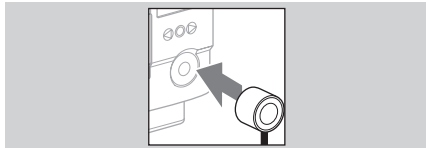

- 2** You can navigate through the "Peripherals" menu with the user keys ▶, ◀ and the selection key ●.

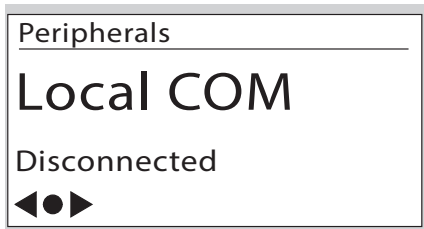

- 3** Press the selection key ●.
- ▷ The screen presents information about the communication status.
- ▷ Optical communication is enabled for 5 minutes.
- ▷ If the optical communications link is not used during this time, the interface will be deactivated.
- 4** Initiate communication.
- ▷ The procedure depends on the user software.

Setting the index parameters

- ▷ The index properties can be adjusted using the user equipment. Please contact the manufacturer.

Changing the battery

⚠ WARNING

Risk of explosion in explosion-hazard areas!

- As a general rule, maintenance and repair work should be avoided in explosive atmospheres.
 - The battery must not be changed or installed in explosive atmospheres.
 - Check that the electrical system complies with the special electrical explosion protection requirements.
 - When working on electrical equipment in an explosion-hazard area, only design-approved electrical operating equipment may be used.
 - Use original spare parts supplied by Honeywell, see page 14 (Spare parts). This pack shall not be altered in any way.
 - There is a risk of explosion if a wrong battery is used.
 - The battery is available as a spare part.
- ▷ The battery can only be changed when no data transmission is running, see symbol for the radio module in the display. Otherwise, data communication will be aborted.

⚠ WARNING

Data loss!

- Ensure that no data are being transmitted.

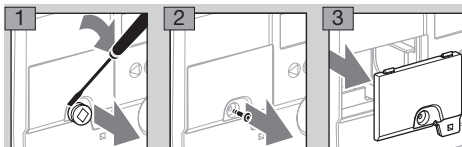

- 4** Start the battery change procedure.

- ▷ The procedure depends on the user software.
- ▷ Replace the battery as quickly as possible.

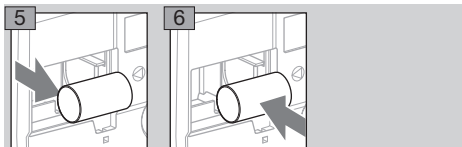

- 7** Reprogram the battery parameters.

- ▷ The procedure depends on the user software.

- 8** Refit the battery cover.

- 9** Push in a new screw locking cap. The body carrying out this task should apply its own seal.

Changing the SIM card

⚠ WARNING

Data loss!

- Ensure that no data are being transmitted.
- Risk of explosion in explosion-hazard areas!
- The SIM connection shall only be used for SIM cards.

- ▷ The SIM card can only be changed when no data transmission is running, see symbol for the radio module in the display. Otherwise, data communication will be aborted.
- ▷ Follow steps **1** to **5** of “Changing the battery”, see section above.
- ▷ The SIM card slot is located at the bottom right-hand corner.

- 1** Press the SIM card briefly to release it from its holder.

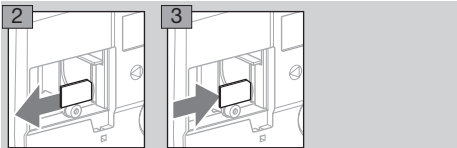

- 4** Insert the new SIM card in the same position and press it briefly to lock the card.

- 5** To refit the battery, follow steps **6** to **9** of “Changing the battery”, see section above.

- ▷ The new SIM card may require a new PIN number.

- 10** Enter the new PIN number via the optical interface. Check the other communications parameters. The procedure depends on the user software.

Electrical pulse output (only for E17)

⚠ WARNING

Risk of explosion in explosion-hazard areas!

- As a general rule, maintenance and repair work should be avoided in explosive atmospheres.
- Check that the electrical system complies with the special electrical explosion protection requirements.
- When working on electrical equipment in an explosion-hazard area, only design-approved electrical operating equipment may be used.
- The intrinsic safety of the connected devices must be proven. The maximum cable length must be determined in the process. Regardless of this, cables longer than 10 m may not be connected. Otherwise, the index could be damaged. A damaged index would then no longer comply with the ATEX requirements.

- ▷ This pulse output is not suitable for metrological testing purposes, but for monitoring the consumption.

- ▷ The generated pulses correspond to the values shown in the technical data, see page 14 (Technical data).
- ▷ When gas consumption is higher than the output can transmit its pulses, the pulses are buffered and will be transmitted afterwards when consumption is low.

Pin assignment:

Pin 1, 2, 4, 6: not connected

Pin 3: output +

Pin 5: output -

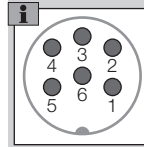

- ▷ To connect the pulse output, use a socket type IEC 60130-9.

Establishing wireless communication

- ▷ GPRS or NB-IoT wireless technology is used depending on the configuration.

- Navigate to the call display in the “GPRS/NB-IoT status” menu.
- Press the selection key **⬇** and hold down.
- Wireless communication will be established.

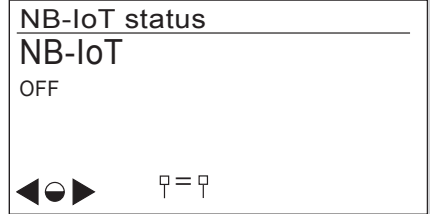

- ▷ The screen presents information about the communication status.

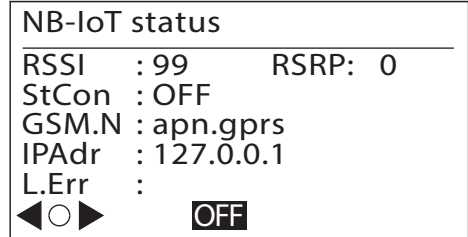

- RSSI = Received Signal Strength Indicator
- RSRP = Reference Signal Received Power
- StCon = connection status of the GPRS module
- GSM.N = Internet address of the access point
- IPAdr = IP address of the communications partner
- L.Err = information about the last connection error

Other screen descriptions (not illustrated):

- BER = Bit Error Rate
- MYIP = IP address assigned by the operator
- HPort = TCP/UDP port number
- Conn = current communication protocol (UDP/TCP)
- ModVer = Modem Version
- Band = GPRS band (900/1800) or NB-IoT band (3/8/20)
- RF = RF communication Enabled/Disabled
- IMEI = International Mobile Equipment Identity number
- ICCID = Integrated Circuit Card Identifier

Releasing the valve

- ▷ If a valve is integrated in the diaphragm gas meter BK, this must be released/opened for commissioning.

! CAUTION

To avoid damage:

- Ensure the customer's consumers are closed.
- ▷ The valve can only be released when the optical communications link has been established or via the wireless interface.
- ▷ Unless otherwise agreed, the valve is open on delivery as standard.
- 1 Establish the optical communications link, see page 8 (Establishing an optical communications link).
- ▷ The procedure for releasing the valve depends on your user software and may differ from the description.
- ▷ The index can be configured so that a password is required to release the valve.

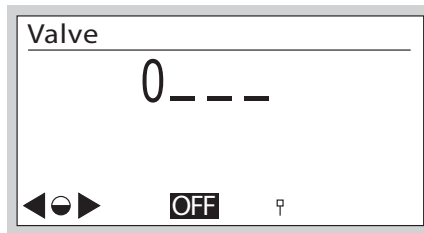

- ▷ The valve release display will then be shown.



- ▷ Press the selection key ● and hold down.
- ▷ After a short time, the unit switches to initialization mode.



- ▷ After successful initialization, the gas flow check is started. The test duration is shown in the display.

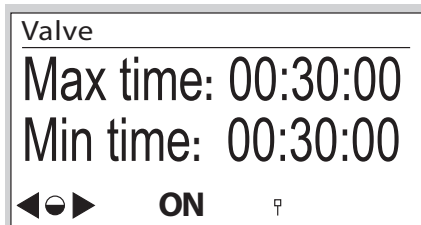

Max time: maximum test duration,
Min time: minimum test duration.

- ▷ The test duration may vary depending on the dimensions of the gas lines downstream of the measuring equipment.
- ▷ Once the release criteria have been checked, the results are shown in the display.



Check test

MID 2014/32/EU prescribes that it must be possible to check the meter.

- ▷ The requirements and test methods must comply with national laws and regulations.
- ▷ The following tests describe the check tests which are carried out by accredited testing agencies.
- ▷ Always conduct a pressure and temperature correction in accordance with established procedures (unit under test against master meter).
- ▷ Measurement accuracy class, see page 14 (Technical data).
- ▷ The unit under test must be acclimatized and installed on the test rig.
- ▷ Maintain the climatic conditions constant during the entire test duration. Otherwise, the test results will be inaccurate.

- ▷ Immediately before the beginning of the test, the quantity of test air, which corresponds to at least 50 x the cyclic volume of the meter to be tested, is fed through the meter at a flow rate of Q_{\max} . (maximum flow rate of a gas meter).
- ▷ During an active cyclic test, the display disappears after 5 minutes but lights up every minute for 10 seconds. This function is available for max. 5 hours.
- ▷ To conduct the tests, the thermowell and the pressure test point (if available) can be used as a reference for the temperature and pressure measured by the index.

Legend

- F_N = error of the master meter in %
- F_P = error of the unit under test in %
- p_{sp} = assumed mean gas pressure, see page 14 (Technical data)
- p_b = base pressure in mbar, see page 14 (Technical data)
- p_N = absolute pressure on the master meter in mbar
- p_P = absolute pressure on the unit under test in mbar
- Q_{\max} = maximum flow rate of a gas meter
- Q_{\min} = minimum flow rate of a gas meter
- Q_N = flow on master meter in m^3/h based on the displayed volume V_N
- $Q_{act,N}$ = actual flow rate on the master meter in m^3/h
- Q_P = flow determined on unit under test based on V_P in m^3/h
- Δt_N = total master meter testing time in s
- Δt_P = testing time of the unit under test in s
- t_b = base temperature in $^{\circ}C$, see page 14 (Technical data)
- T_b = base temperature in K, $T_b = (273.15 + \{t_b\}) K$
- t_g = relevant temperature on the unit under test in $^{\circ}C$
- T_g = relevant temperature on the unit under test in K, $T_g = (273.15 + \{t_g\}) K$
- T_N = absolute temperature on the master meter in K
- T_P = absolute temperature on the unit under test in K
- V_b = converted volume
- V_N = displayed volume on master meter in m^3
- $V_{act,N}$ = actual volume on master meter in m^3
- V_P = volume on unit under test in m^3
Value after C or U in display, depending on device configuration and test method. See test procedure below for further details.
- ▷ Only a conversion for the temperature (to t_b) is completed for the converted volume V_b for gas meters BK...ETe.
- ▷ The curly brackets mean "numerical value of".

Cyclic test

- ▷ The cyclic test is designed for checking the meter with a master meter.
- ▷ The recorded volume of the unit under test during the testing period can be read off directly from the index once the test has been completed and can be compared with the master meter. Testing at a constant flow rate thus ensures the lowest possible level of measurement uncertainty for the unit under test.

* Cyclic test: start

C : 00.000000 m^3
 U : 00.000000 m^3
 tg : 25.04 $^{\circ}C$ pg: 1023.25 mbar
 N : 00000-0 t: 00000.00 s
 Press ● to abort test

C = converted volume

U = non-converted volume

t_g = measured gas temperature

p_g = measured gas pressure

N = number of complete measuring cycles (measuring unit revolutions) - number of intermediate sampling points in the measuring cycle (max. 8)

t = total testing time in seconds

- ▷ The display may vary depending on the meter type. If necessary, measure the values on the unit under test.

The following relationships apply to the displayed volumes:

BK-G...E	C = U (no conversion)
BK-G...ETe	C = V_b , conversion to t_b U = V_P , non-converted volume $V_b = V_P \times T_b/T_g$
BK-G...ETeB	C = V_b , conversion to t_b and p_b , without determining the actual pressure U = V_P , non-converted volume $V_b = V_P \times T_b/T_g \times p_{sp}/p_b$
BK-G...B	C = V_b , conversion to t_b and p_b U = V_P , non-converted volume

- ▷ The following error calculations are based on PTB Testing Instructions, Volume 29 "Messgeräte für Gas – Gaszähler" (Measuring instruments for gas – gas meters), Edition 2003.
- ▷ The values required in formula F_P , see page 12 (Cyclic test at a constant flow rate) and page 13 (Cyclic test with a given volume), for V_X , T_X and p_X are determined as follows:

For testing using the converted volume:

	$V_X =$	$T_X =$	$p_X =$
BK-G...E	C	T_P	p_P
BK-G...ETe		$(273.15 + \{t_b\}) K$	
BK-G...ETeB	$C \times p_P / p_{sp}$		p_b
BK-G...B	C		

C: see display

t_b , p_{sp} , p_b : see Technical data

For testing using the non-converted volume:

	$V_X =$	$T_X =$	$p_X =$
BK-G...E	U	T_P	p_P
BK-G...ETe		$(273.15 + \{t_g\}) K$	
BK-G...ETeB			p_g
BK-G...B			

U, t_g , p_g : see display

Cyclic test at a constant flow rate

▷ The test rig is in pre-trial operation, i.e. start of measurement on the unit under test will be delayed.

▷ Maintain the flow rate constant.

Test load and minimum test volumes for the test with index readout:

Type	Q_{max} in m^3/h	Cyclic volume in dm^3	Test volume in dm^3 at		
			Q_{min}	$0.2 Q_{max}$	Q_{max}
BK-G1.6	2.5	1.2	1.2	12	60
BK-G2.5	4.0	1.2	1.2	12	60
BK-G4	6.0	1.2	1.2	12	60
BK-G2.5	4.0	2	2	20	100
BK-G4	6.0	2	2	20	100
BK-G6	10	2	2	20	100
BK-G6	10	4	4	40	200
BK-G6	10	6	6	60	300
BK-G10	16	6	6	60	300
BK-G16	25	6	6	60	300
BK-G25	40	12	12	120	600
BK-G40	65	18	18	180	900
BK-G65	100	24	24	240	1200
BK-G100	160	48	48	480	2400

▷ The minimum test volumes are recommended guide values. The measurement uncertainty of the complete system (test rig plus unit under test) must not exceed 1/3 of the maximum permissible error (MPE). The testing time must be at least 10 s.

▷ In the test procedure described below, it is guaranteed that the unit under test always performs full measuring unit rotations.

Master meter test procedure

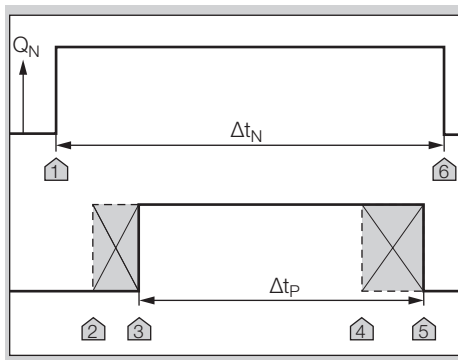

- 1 Set the test flow rate.
- 2 Start measuring the reference time Δt_N at marker 1.
- 3 Immediately afterwards, briefly press the selection key ● on the index to start the cyclic test on the unit under test – marker 2. The index will thus be “armed” for measurement.
 - ▷ As soon as one of the significant sensor positions has been detected, the unit changes to measuring mode – marker 3.
 - ▷ Once the required minimum testing time has been reached, the measurement can be terminated – marker 4.
- 4 Briefly press the selection key ● in order to end the measurement.
 - ▷ Measurement on the unit under test stops automatically once the full number of measuring unit revolutions has been completed – marker 5.
 - ▷ Measurement is terminated automatically after 5 hours.
- 5 Stop the test on the master meter – marker 6.
 - ▷ The measurements are then available.
- 6 Read off the flow rate on the master meter or calculate if necessary:
 - a) taking into account the inherent error of the master meter:
 $Q_{act,N} = V_N \times 3600 \text{ s/h} / ((1 + F_N/100) \times \Delta t_N)$
 - b) If the inherent error of the master meter has already been taken into account in the displayed volume ($V_N = V_{act,N}$):
 $Q_{act,N} = V_{act,N} \times 3600 \text{ s/h} / \Delta t_N$
- 7 Calculate the flow rate on the unit under test:
 $Q_P = V_X / \Delta t_P$.
- 8 The accuracy is checked by comparing the flow rates. The pressure and temperature values of the unit under test corrected with reference to the master meter have already been taken into account here:
 $F_P = 100\% \times (((Q_P \times p_X \times T_N) / (Q_{act,N} \times p_N \times T_X)) - 1)$
 - ▷ On a nozzle test rig with a known flow rate, steps 2 and 6 can be omitted.

- ▷ The error calculation is based on PTB Testing Instructions, Volume 29 "Messgeräte für Gas – Gaszähler" (Measuring instruments for gas – gas meters), Edition 2003.

Cyclic test with a given volume

Test load and minimum test volumes for the test with index readout:

Type	Q _{max.} in m ³ /h	Cyclic volume in dm ³	Test volume in dm ³ at		
			Q _{min.}	0.2 Q _{max.}	Q _{max.}
BK-G1.6	2.5	1.2	36	72	72
BK-G2.5	4.0	1.2	36	72	72
BK-G4	6.0	1.2	36	72	72
BK-G2.5	4.0	2	60	120	120
BK-G4	6.0	2	60	120	120
BK-G6	10	2	60	120	120
BK-G6	10	4	120	240	120
BK-G6	10	6	180	360	360
BK-G10	16	6	180	360	360
BK-G16	25	6	180	360	360
BK-G25	40	12	360	720	720
BK-G40	65	18	540	1080	1080
BK-G65	100	24	720	1440	1440
BK-G100	160	48	1440	2880	288

Master meter test procedure

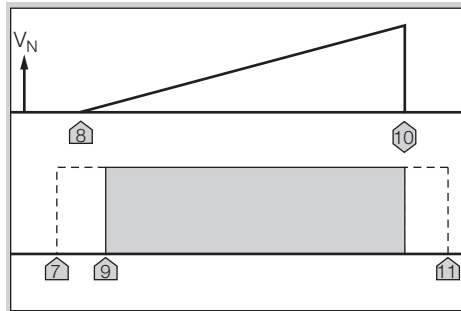

- To activate the cyclic test on the unit under test, briefly press the selection key ● on the index – marker 7. The index will thus be "armed" for measurement.
- Start the test on the master meter – marker 8.
 - ▷ As soon as one of the significant sensor positions has been detected, the unit changes to measuring mode – marker 9.
- Test is ended – marker 10.
- Read off the test results on the unit under test.
 - ▷ The measured values are updated with each 1/8 revolution of the measuring unit.
- Compare the measurement results with the master meter and determine the measuring deviation on the unit under test:
 - taking into account the inherent error of the master meter:

$$F_P = 100\% \times \left(\frac{(V_N \times (1 + F_N/100) \times p_X \times T_N)}{(V_N \times p_N \times T_X)} - 1 \right)$$
 - If the inherent error of the master meter has already been taken into account in the displayed volume ($V_N = V_{act,N}$), the following applies:

$$F_P = 100\% \times \left(\frac{(V_X \times p_X \times T_N)}{(V_{act,N} \times p_N \times T_X)} - 1 \right)$$

- Stop execution of the cyclic test – marker 11. Briefly press the selection key ● twice in order to stop the measurement.
 - ▷ Measurement is terminated automatically after 5 hours.

RTC test

- ▷ The climatic conditions must be maintained constant at $22 \pm 5^\circ\text{C}$ during the entire test duration. Temperature changes in 24 hours ≤ 2 K.
- ▷ Ensure that conditions remain sufficiently stable during the measurement.
- ▷ The accuracy of the time count can be verified with this test.
 - Acclimatize the unit under test and place next to the time reference unit.
 - If necessary, activate the time display on both units.
 - Ensure synchronous reading by taking a photo.
 - Observe a min. testing time of 72 hours.
 - Repeat steps 2 and 3.
 - Accuracy of the clock, see page 14 (Technical data).

Temperature test

- ▷ A temperature test is required on diaphragm gas meters with temperature conversion BK..Te only.
- ▷ The accuracy of the temperature measurement can be verified with this test.
- ▷ The temperature test can only be carried out in Service mode.

! CAUTION

To avoid damage to the unit:

- Comply with ambient temperature, see page 14 (Technical data). Deviations from the permitted ambient temperature will be recorded in the error memory.
- ▷ Temperature measurement accuracy, see page 14 (Technical data).
 - Install the diaphragm gas meter in a climatic chamber.
 - Activate Service mode – see page 6 (Service mode).
 - Change to the "Cyclic test" menu.
 - ▷ The current gas temperature is displayed.
 - Close the climatic chamber.
 - Select an ambient temperature as a reference value and bring the climatic chamber to this temperature.
 - ▷ To ensure there is also a uniform temperature in the meter, we recommend starting the meter air/gas flow during the temperature adjustment phase.
 - Ensure that temperature distribution remains uniform and stable during the temperature measurement.
 - Compare the measured value to the temperature reference value.

- ▷ If required, several reference values can be checked. In this case, repeat the test as of point **5**.

Assistance in the event of malfunction

- ? **Fault**
- ! **Cause**
- **Remedy**

Possible faults and suggested solutions

- ? When pressing the user keys, the display remains switched off.
 - ! The index is defective.
 - Contact the manufacturer.
- ? The  symbol is displayed.
 - ! Low battery. This symbol is only displayed when battery power is low.
 - Replace the battery.
- ▷ In the case of faults which are not described here, contact the manufacturer immediately.

Maintenance

- ▷ The housing can be cleaned using a damp cloth. To prevent static electricity charge, never use a dry cloth.
- ▷ For maintenance, refer to the operating instructions for diaphragm gas meters BK-G1.6 to BK-G25 → http://docuthek.kromschroeder.com/doclib/main.php?language=1&folderid=400041&by_class=2&by_lang=-1.

Accessories

External antenna

Order No.: 72910447, "Retrofit kit external antenna EI6/EI7"

WARNING

- Risk of explosion in explosion-hazard areas!
- The maximum RF power shall not exceed 3.5 W, and the maximum RF energy (Zth) shall not exceed 250 µJ when an external antenna is used with the EI7. Furthermore, the external antenna shall not have another source of power except the EI7.

Spare parts

Only the following spare parts are approved:

Battery

- Order No.: 72910350, "Spare parts kit battery pack EI6".
- Order No.: 72910455, "Spare parts kit battery pack EI6 3-pole connector".
- Order No.: 72910448, "Spare parts kit battery pack EI7", includes battery 32448442.

Screw locking cap

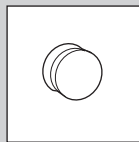

Order No.: 32447510.

Technical data

RoHS compliant
 Enclosure: IP 65.
 Battery service life: approx. 16 years (communication may be restricted after 8 years).
 Accuracy of the clock: 9 s/day at 20°C on the day of manufacture.
 Temperature measurement accuracy on the day of manufacture:
 ± 1°C in the range from 0°C to 30°C.
 ± 2°C in the range from -25°C to 0°C and from 30°C to 55°C.
 Communication: GPRS/NB-IoT.
 GPRS wireless technology – GSM900:
 Frequency band: 880 MHz to 960 MHz
 Output power: 33 dBm

GPRS wireless technology – DCS1800:
 Frequency band: 1710 MHz to 1880 MHz
 Output power: 30 dBm

NB-IoT wireless technology – LTE Cat NB1 B3:
 Frequency band: 1710 MHz to 1880 MHz
 Output power: 23 dBm

NB-IoT wireless technology – LTE Cat NB1 B8:
 Frequency band: 880 MHz to 960 MHz
 Output power: 23 dBm

NB-IoT wireless technology – LTE Cat NB1 B20:
 Frequency band: 791 MHz to 862 MHz
 Output power: 23 dBm

Data logger for historic meter readings:
 up to 190 days in hourly intervals.
 Optical interface: pursuant to EN 62056-21, Mode (E), Annex B.2.

The battery is certified as part of the electronic index. Only use original spare parts supplied by Honeywell. Suitable battery, see page 14 (Spare parts).

For more technical data on the diaphragm gas meter BK, see:

Operating instructions for diaphragm gas meters BK-G1.6 to BK-G25 or operating instructions for industrial diaphragm gas meters Type BK-G40... → www.docuthek.com

For meters BK-G...ETeB:

- ▷ The mean pressure p_{sp} at the inlet is assumed to be a fixed value.
- ▷ A fixed conversion to the base pressure p_b is carried out, without the actual pressure being determined.

Electrical pulse output (ST3) (E17 only)

Type of switch: open collector transistor, normally open

Maximum pulse frequency: 16 Hz

Minimum pulse duration: 32 ms

Pulse value:

Gas meter	Decimal place in display	Pulse value V_{Imp} in dm^3
BK-G1.6–BK-G6	3	10
BK-G10–BK-G65	2	100
BK-G100	1	1000

Interface parameters:

Intrinsically safe circuit “ia” with the following maximum values:

- $U_i = 12$ V DC
- $I_i = 10$ mA
- $P_i = 120$ mW

The internal energy accumulators effective to the outside are as follows:

- $C_i = 2$ nF
- $L_i =$ negligible

Logistics

Transport

Diaphragm gas meters are always to be transported in the upright position. On receipt of the product, check that the delivery is complete, see page 2 (Part designations). Report any transport damage immediately.

Storage

Diaphragm gas meters are always to be stored in the upright position and in a dry place. Ambient temperature: see page 14 (Technical data).

Disposal

Meters with electronic components:

Components, particularly batteries, are to be disposed of separately.

On request, old units may be returned carriage paid to the manufacturer, see page 16 (Contact), in accordance with the relevant waste legislation requirements.

Data security

To ensure correct metrological operation and data security, the metrological seal and the housing must not be damaged.

The meters must always contain the latest firmware version.

Data protection

Honeywell can read data from a meter sent in for quality control and diagnostics using a physical connection.

Honeywell has access to:

- Configuration data
- Technical log files
- Device statistics
- Consumption data
- Meter identifiers

Data will not be forwarded to a 3rd party. Honeywell cannot access the data by means of a remote interface.

Reporting a vulnerability

A vulnerability is defined as a software error or a weakness which can be exploited to adversely affect or reduce the performance or security functions of the software.

Honeywell reviews all vulnerability reports relating to Honeywell products and services. Details of Honeywell's security policies are available at: <https://www.honeywell.com/product-security>.

If you would like to report a potential vulnerability for a Honeywell product, follow the instructions at: <https://www.honeywell.com/product-security> in the section entitled “Vulnerability Reporting”.

Information about current malware threats which may affect industrial control equipment is available at: <https://www.honeywellprocess.com/en-US/support/Pages/security-updates.aspx>

Safe disposal of consumption data

All the PCBs, which may contain sensitive software and/or personal data, must be disposed of using a method which ensures that the data cannot be restored (e.g. shredding by a certified waste disposal contractor).

Software licenses

This device uses open source software. For further details, see www.docuthek.com.

Contact

Honeywell

Germany

Elster GmbH
Strotheweg 1
49504 Lotte
Tel. +49 541 1214-0
Fax +49 541 1214-370
info-instromet-GE4N@honeywell.com
www.elster-instromet.com

United Kingdom

Elster Metering Limited
Paton Drive
Tollgate Business Park
Beaconside
Stafford, ST16 3EF
Tel. +44 1785 275200
Fax +44 1785 275300
solution.elster@honeywell.com
www.elster-instromet.com

Ireland

Active Energy Control Ltd.
Unit 4, Clare Marts
Quin Road
Ennis, Co. Clare
Tel. +353 65 6840600
Fax +353 65 6840610
info@aec.ie
www.aec.ie