

Operating instructions

White meters BK V2 to BK V12 (component of a diaphragm gas meter)



Contents

White meters BK V2 to BK V12 (component of a diaphragm gas meter)	1
Contents	1
Safety	1
Checking the usage	2
White meters BK V2 to BK V12	2
Type code	2
Part designations	2
Type label/Marking	2
Integrated pressure and temperature sensor (optional)	3
Integrated valve (optional)	3
Installation	4
Temperature test point	4
Pressure test point on housing (optional)	4
Connecting the piping	4
Pressure test point on outlet connector (optional)	5
Opening the test nipple	5
Closing the test nipple	5
Tightness test	5
Commissioning	6
Maintenance/Removal	6
Technical data	6
Declaration of conformity	7
White meters BK V2 – V12 with explosion protection	7
White meters BK V2 with explosion protection and integrated valve Ve	8
ATEX legend	9
Logistics	9
Contact	10

Safety

Please read and keep in a safe place



Please read through these instructions carefully before installing or operating. Following the installation, pass the instructions on to the operator. This unit must be installed and commissioned in accordance with the regulations and standards in force. These instructions can also be found at www.docuthek.com.

Explanation of symbols

■, **1**, **2**, **3**... = Action
> = Instruction

Liability

We will not be held liable for damage resulting from non-observance of the instructions and non-compliant use.

Safety instructions

Information that is relevant for safety is indicated in the instructions as follows:

⚠ DANGER

Indicates potentially fatal situations.

⚠ WARNING

Indicates possible danger to life and limb.

! CAUTION

Indicates possible material damage.

All interventions may only be carried out by qualified gas technicians. Electrical interventions may only be carried out by qualified electricians.

Conversion, spare parts

All technical changes are prohibited. Only use OEM spare parts.

Changes to edition 07.20

The following chapters have been changed:

- Checking the usage
- Declaration of conformity
- Contact (AT)

Checking the usage

White meters BK V2 to BK V12

White meters are components of diaphragm gas meters and cannot be operated independently. They are suitable for recording gas consumption values for natural gas, town gas, propane and butane, as gases of the first to third families pursuant to DIN EN 437:2003 (DVGW Code of Practice G260), and can be extended to form complete diaphragm gas meters by installing an index.

The following sizes of gas meter can be assembled from the listed white meters:

Meter	Size
BK V2	G4
BK V2S	G4, G6
BK V6	G6, G10, G16
BK V12	G25

Potentially explosive atmosphere

White meters that are marked with **CE** and  (see sticker on the baseplate) are suitable for operation in potentially explosive atmospheres, see page 7 (Declaration of conformity).

- ▷ If a pressure/temperature sensor is integrated in the white meter, this must be included in the ATEX assessment of the control electronics.

The meter function is only guaranteed when used under the specified operating conditions – see page 6 (Technical data). Any other use is considered as non-compliant.

Type code

Code	Description
BK V	Meter
	Cyclic volume:
2	2 dm ³
6	6 dm ³
12	12 dm ³
S	Increased flow cross-sections

Part designations

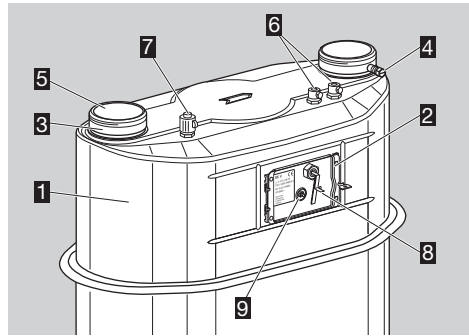

- 1 White meter BK V
- 2 Base plate with type label
- 3 Connectors
- 4 Pressure test point to BS4161 (optional)
- 5 Protective caps
- 6 2 x thermowells (optional)
- 7 Pressure test point with sealing sleeve (optional)
- 8 Connection cable for internal pressure and temperature sensor (optional)
- 9 Index drive (inner part of the magnetic coupling)

Type label/Marking

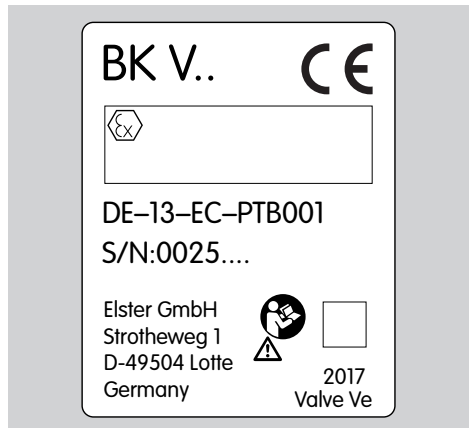

- Device designation BK V..
- Evaluation certificate No. DE-13...
- Serial number S/N...
- Manufacturer's address
- Year of construction

White meters with no integrated valve

- CE marking and ATEX identification
 -  II -/2 G Ex h IIB T5
 - TÜV 11 ATEX 090370 X
- ATEX-compliant use is as follows:
 Category: internal: none, external: Category 2 (Zone 1).
 Type of atmosphere: gases, hazes and vapours.

White meters with integrated valve Ve

- CE marking and ATEX identification
 II 3 G IIB T4
17 ATEX 1431X
- Valve marking
Ve = bi-stable valve for electronic flow rate testing

ATEX-compliant use is as follows:

Category: 3 (Zone 2).

Type of atmosphere: gases, hazes and vapours.

Integrated pressure and temperature sensor (optional)

As an option, a combined pressure/temperature sensor of type KP089 made by elgas s.r.o. (Czech Republic) can be integrated in the meter.

In this case, the conductors of the connection cable are assigned as follows:

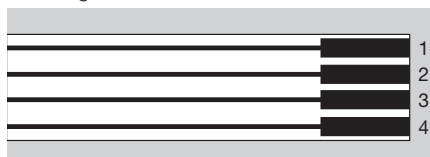

- 1 VCC (voltage supply 2.8 to 3.6 V)
- 2 SDA (data signal of the I²C bus)
- 3 GND (system ground)
- 4 SCL (clock signal of the I²C bus)

Integrated valve (optional)

A valve of type Ve may be integrated in the meter as an option. This is marked on the type label below the year of construction with the note "Valve Ve".

WARNING

Risk of explosion in explosion-hazard areas!

- The intrinsic safety of the control electronics must be proven.
 - When working on electrical equipment in an explosion-hazard area, only design-approved electrical operating equipment may be used.
 - Check that the electrical system complies with the special electrical explosion protection requirements.
 - Note the permitted connection ratings of the interfaces. See page 6 (Technical data), White meters BK V with explosion protection and integrated valve Ve.
- ▷ A connection cable leads out of the meter.
 - ▷ There is a detailed specification for actuating the valve and using the interface. Please contact the manufacturer.
 - ▷ The manufacturer of the control electronics is responsible for creating the conditions required for safe operation of the valve. Instructions on commissioning and operation are to be taken



from the operating instructions for the control electronics.

- ▷ Technical data, see page 6 (Technical data).

Installation

WARNING

Please observe the following to ensure that neither persons nor the meter are damaged during installation and operation:

- Note the max. allowable operating pressure p_{\max} and measuring range Q_{\max} , see page 6 (Technical data).
- Note the permitted ambient temperature t_m and gas temperature t_g , see page 6 (Technical data).
- The white meters are certified for mechanical environments pursuant to Class M1 of Directive 2014/32/EU. When installed, the meters must not be subject to permanent vibration such as that caused by machines in the vicinity. In case of doubt, vibration isolation must be provided.
- When installing meters with integrated valves, make sure that no dirt particles get into the meter and thus into the valve.
- The yellow sealing sleeve protects the pressure test point on the meter. It may only be opened for connecting a pressure measuring line.
- Use seals made from tested materials. Elastomer seals or asbestos-free flat seals from Elster are recommended.
- Only use the seals once.
- For meters resistant to high temperatures, only use seals tested to be resistant to high temperatures.
- For installation and operation, note the applicable national regulations and the directives of the gas supply company. For Germany, the valid DVGW Code of Practice G600 (DVGW-TRGI) applies.
- Work on meters and the installation of meters which are marked with  and are installed in potentially explosive atmospheres may only be carried out by persons with appropriate qualifications.
- The meter marked with  must be included in the equipotential bond when being installed in a potentially explosive atmosphere, e.g. by connecting it to a grounded pipeline. Installation must be carried out in accordance with EN 60079-14.
- The meter marked with  must be protected from falling parts.
- Avoid subjecting the unit to mechanical stress and prevent damage. Gas meters must be installed without any mechanical stress, preferably only by suspending them on the connectors. When using additional clamps, it must be ensured that no lateral forces act on the gas meter. These can be avoided by using flexible or supply connection lines, for instance.

- ▷ If the meter is stored outdoors, protect the site against rain.
- ▷ If the drive area (magnetic coupling) is protected against the ingress of moisture by an index, then the meter is also suitable for outdoor installation.

1 Remove protective caps.

- ▷ Installation in the vertical position: connectors must be pointing upwards.
- ▷ Note direction of flow (arrow).
- ▷ After installation, the completed gas meter must not be in contact with masonry or other parts.
- ▷ Ensure that there is sufficient installation space.
- ▷ The seal faces on the screw unions must be clean and damage-free.
- ▷ Ensure that the seal is correctly seated.
- ▷ For the compression of seals and the resulting tightening torques for the screw unions, the seal manufacturers' specifications must be observed. Tightening torques for the recommended flat seals in conjunction with screw connectors pursuant to DIN 3376-1 and 3376-2, see www.docuthek.com → Elster-Instromet → Products → Gas measuring devices → Diaphragm meters → Ergänzung für Betriebsanleitung BK, Verschraubungen und Anzugsmomente für BK-G1,6 bis BK-G25 (Supplement to BK operating instructions, Screw unions and tightening torques for BK-G1.6 to BK-G25) (D).

2 Install the meter free of mechanical stress.

Temperature test point

- ▷ Temperature sensors can be inserted into the thermowells for measuring the gas temperature in the meter housing.

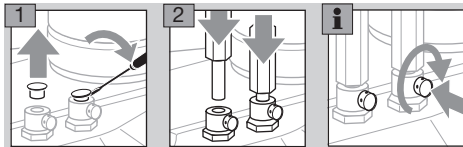

3 Secure each of the temperature sensors using the capstan screw provided.

Pressure test point on housing (optional)

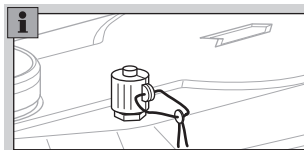

Connecting the piping

⚠ WARNING

In order to ensure that the meter is tight:

- The pressure test nipple must not be twisted, bent, or otherwise manipulated.
 - When installing, always secure the pressure test nipple using a suitable spanner.
- ▷ Functional safety and reliability are ensured only if the material combination of the screw connector and the pressure line are inter-matched.
 - ▷ Only use the olive and the attached union nut supplied. The olive is secured to the sealing sleeve.
 - ▷ When re-ordering, use original Parker EO progressive ring fittings PSR/DPR.

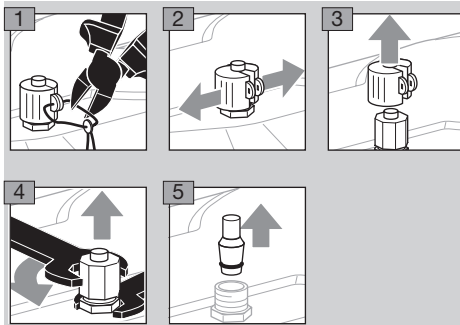

- ▷ Use corrosion-resistant, seamless precision steel tube pursuant to DIN EN 10305-4 (external diameter 6 mm, material E235 = 1.0308). For other materials, use a suitable adapter and note the Parker/EO recommendations.
- ▷ Install pipes free of mechanical stress.

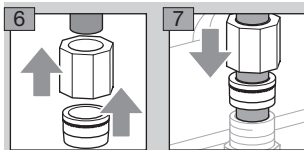

- 8 Screw on the union nut by hand as far as it will go.
- ▷ At the same time, press the end of the pipe firmly against the stop.
- 9 Mark the position of the union nut and tighten with about 1½ turns.

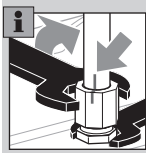

- ▷ When reinstalling, the union nut will be turned to the original position and then further tightened through approx. 30°.
- 10** Once the installation and tightness test are complete, see page 5 (Tightness test), protect the pressure test point against external access with the sealing sleeve and the seal.

Pressure test point on outlet connector (optional)

BS4161-compliant pressure test nipple

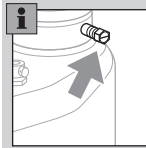

- ▷ Use a 10 mm spanner to release/tighten the test point screw.
- ▷ The test nipple is secured to prevent it turning with the screw.

Opening the test nipple

- 1** Remove the screw from the test nipple completely.
- ▷ The gas connection is open.

Closing the test nipple

- 1** Insert the screw by hand as far as possible.
- 2** Tighten the screw with a torque of 3 Nm + 0.5 Nm.
- 3** Check for tightness, see page 5 (Tightness test).

⚠ WARNING

If the test nipple has unexpectedly come loose, the gas meter must be regarded as damaged and must be replaced.

Tightness test

- ▷ Check the pipework for leaks prior to installation of the meter, in case the pipework is tested with a greater test pressure than the max. allowable operating pressure p_{max} for the meter. Otherwise, the installed meter may be damaged.
- ▷ Ensure the customer's consumers are closed.

- 1** Apply the test pressure slowly to the meter.

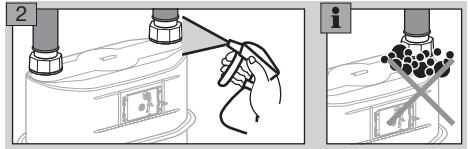

- ▷ If a pressure measuring line has been retrofitted to the meter, check this connection for tightness.

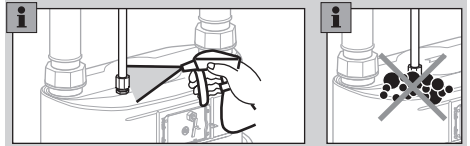

- ▷ If the BS4161-compliant test nipple on the meter has been opened and then closed again, test this connection for tightness.

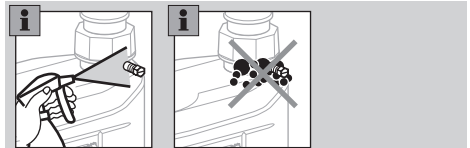

- 3** After the tightness test, slowly vent the meter.
- 4** If a pressure measuring line has been retrofitted to the meter, protect the pressure test point against external access with a sealing sleeve and a seal.

Commissioning

Once the tightness test has been successfully completed, the meter is ready for operation. Where applicable, further instructions are required for a fitted index.

▷ Slowly open the manual valve.

White meters with integrated valve

In the event that the white meter is fitted with an integrated valve, the gas supply can be connected or disconnected remotely.

Unless otherwise agreed, the valve is open on delivery as standard.

WARNING

- The grid operator is responsible for the safe remote shut-down and restart of the white meter.
 - The integrated valve does not assume the functions of a safety shut-off valve.
- ▷ The technical data of the valve control interface is to be requested from Elster GmbH and observed.
- ▷ The manufacturer of the control electronics is responsible for creating the conditions required for safe operation of the valve. Instructions on commissioning and operation are to be taken from the operating instructions for the control electronics.

Maintenance/Removal

Meters BK V2 to BK V12 from Elster are maintenance-free. Where applicable, further maintenance instructions are to be observed for a fitted index.

- ▷ If the screw unions are loosened for maintenance work or retesting, replace the seals.
- ▷ After the meter has been removed, immediately close the connectors with protective caps in order to prevent ingress of dirt particles.

WARNING

A certain amount of gas may remain in the meter. Taking into consideration the risk of explosion, it is important to adopt safety measures, e.g.:

- Following removal of the meter, purge it thoroughly with inert gas.
- For transporting the meter with gas residue, use a vehicle with an open or a ventilated loading area.

Technical data

Gas type: natural gas, town gas, propane and butane, as gases of the first to third families pursuant to DIN EN 437:2003 (DVGW Code of Practice G260).

- Note the max. allowable operating pressure $p_{\max} = 0.1$ bar (HTR version)/0.5 bar (non-HTR)
- ▷ HTR: high temperature resistance pursuant to EN 1359:1998+A1:2006, section 6.5.5
- Measuring range (in accordance with Evaluation certificate DE-13-EC-PTB001):

Type	Q_{\min}/Q_{\max} in m^3/h
BK V2	0.04 / 6
BK V2S	0.04 / 6
BK V2S	0.06 / 10
BK V6	0.06 / 10
BK V6	0.06 / 16
BK V6	0.10 / 16
BK V6	0.10 / 25
BK V6	0.16 / 25
BK V12	0.25 / 40
- Max. allowable ambient temperature range
 $t_m = -25^\circ\text{C}$ to $+55^\circ\text{C}$
- Max. allowable gas temperature range
 $t_g^* = -25^\circ\text{C}$ to $+55^\circ\text{C}$
- Cyclic volume V
BK V2, BK V2S: $V = 2 \text{ dm}^3$
BK V6: $V = 6 \text{ dm}^3$
BK V12: $V = 12 \text{ dm}^3$
- Transitional flow rate $Q_t = 0.1 \times Q_{\max}$
- Max. allowable storage temperature range:
 -25°C to $+60^\circ\text{C}$
- Mechanical environment class: M1

Supplementary notes:

- * If operated within the gas temperature range, the measuring error still lies within the required error limits.

White meters BK V with pressure test point

Pressure test point: 24° olive fitting to EN ISO 8434-1, L6 x M12 x 1.5-St.

White meters BK V with integrated valve Ve

Max. operating pressure for valve operation: 100 mbar.

- ▷ The operating pressure of the gas meter can be higher if necessary.

Leakage flow (closed): max. 1 l/h up to 100 mbar.

White meters BK V with explosion protection and integrated valve Ve

For meters of Category 3 which are marked with , the ambient temperature t_{amb} and the gas temperature t_{gas} are limited to a maximum range between -20°C and $+55^\circ\text{C}$.

In addition, the following interface parameters apply for BK V:

- $U_i = 4.1 \text{ V}$
- $C_i = \text{negligible}$
- $L_i = 3.82 \text{ mH}$

White meters BK V2 – V12 with explosion protection

Honeywell



EU-Konformitätserklärung EU Declaration of Conformity

Produkt
Product

Rohzähler (Teilergeräte von Gaszählern)
White meters (sub-assemblies of gas meters)

Typ, Ausführung
Type, Model

BK V2 – BK V12

Produkt-Kennzeichnung
Product marking

II -/2 G Ex h IIB T5

EU-Richtlinien
EU Directives

2014/34/EU – ATEX
2014/34/EU

Normen
Standards

EN ISO 80079-36:2016
EN ISO 80079-37:2016
EN 60079-0:2012 + A11:2013
EN 60079-11:2012

Prüfungen
Approvals

Konformitätsaussage
Statement of conformity
TÜV 11 ATEX 090370 X Ausgabe 01 (Edition 01)
TÜV NORD CERT GmbH, Am TÜV 1, 30519 Hannover

Konformitätsbewertungsverfahren 2014/34/EU Anhang VIII, Modul A
Conformity Assessment Procedure 2014/34/EU Annex VIII, module A

Wir erklären als Hersteller:

Die entsprechend gekennzeichneten Produkte erfüllen die Anforderungen der aufgeführten Richtlinien und Normen. Sie stimmen mit dem geprüften Baumuster überein. Die Herstellung unterliegt dem genannten Konformitätsbewertungsverfahren.

We declare as manufacturer:

Products labelled accordingly meet the requirements of the listed directives and standards. They correspond to the tested type samples. The production is subject to the stated conformity assessment procedure.

Unterzeichnet für und im Namen der Elster GmbH – Signed for and on behalf of Elster GmbH

Lotte / Stará Turá, 2021-01-07

DocuSigned by:

9502A259719243E

Ulrich Clasemann
Geschäftsführer Standort Lotte
Managing Director, Lotte site

DocuSigned by:

8F881987CB8A4A2

Guido Temme
Leiter Entwicklung Gasmessung
Director R&D Gas Metering

DocuSigned by:

F4C60155E8A048B

Peter Bernhauser
Betriebsleiter Standort Stará Turá
Plant Director, Stará Turá site

Elster GmbH, Strothweg 1, 49504 Lotte, DEUTSCHLAND / GERMANY

**EU-Konformitätserklärung**
*EU Declaration of Conformity***Produkt***Product*Rohzähler (Teilgeräte von Gaszählern)
*White meters (sub-assemblies of gas meters)***Typ, Ausführung***Type, Model***BK V2** (Ausführung mit Ventil)
*(variant with valve)***Produkt-Kennzeichnung***Product marking*

II 3 G IIB T4

EU-Richtlinien*EU Directives***2014/34/EU – ATEX**
*2014/34/EU***Normen***Standards*

EN 1127:2011

Prüfungen*Approvals*17 ATEX 1431 X
Elster GmbH, Strothweg 1, 49504 Lotte**Konformitätsbewertungsverfahren***Conformity Assessment Procedure*2014/34/EU Anhang VIII, Modul A
*2014/34/EU Annex VIII, module A***Wir erklären als Hersteller:**

Die entsprechend gekennzeichneten Produkte erfüllen die Anforderungen der aufgeführten Richtlinien und Normen. Sie stimmen mit dem geprüften Baumuster überein. Die Herstellung unterliegt dem genannten Konformitätsbewertungsverfahren.

We declare as manufacturer:

Products labelled accordingly meet the requirements of the listed directives and standards. They correspond to the tested type samples. The production is subject to the stated conformity assessment procedure.

Unterzeichnet für und im Namen der Elster GmbH – *Signed for and on behalf of Elster GmbH*

Lotte / Stará Turá, 2021-01-21

DocuSigned by:

980DA216719245E

Ulrich ClasemannGeschäftsführer Standort Lotte
Managing Director, Lotte site

DocuSigned by:

DF091987CDA9A2

Guido TemmeLeiter Entwicklung Gasmessung
Director R&D Gas Metering

DocuSigned by:

F4C90158EA6D49B

Peter BernhauserBetriebsleiter Standort Stará Turá
*Plant Director, Stará Turá site***Elster GmbH, Strothweg 1, 49504 Lotte, DEUTSCHLAND / GERMANY**

ATEX legend

-  = Marking of explosion protection
- II = Equipment group II for general industries (with the exception of mines)
- /2 = Category:
 - internal: none
 - external: Category 2 (Zone 1)
- 3 = Category 3 (Zone 2)
- G = Type of atmosphere: gases, hazes and vapours
- Ex h = "Constructional safety" explosion protection type
- IIB = Explosion group for gases
- T4 = Temperature class: maximum allowable surface temperature 135°C
- T5 = Temperature class: maximum allowable surface temperature 100°C

Logistics

Transport

Diaphragm gas meters are always to be transported in the upright position. On receipt of the product, check that the delivery is complete, see page 2 (Part designations). Report any transport damage immediately.

Storage

Diaphragm gas meters are always to be stored in the upright position and in a dry place. Ambient temperature: see page 6 (Technical data).

Disposal

Components are to be disposed of separately.

On request, old units may be returned carriage paid to the manufacturer, see page 10 (Contact), in accordance with the relevant waste legislation requirements.

Honeywell

Germany

Elster GmbH
Strotheweg 1
49504 Lotte
Tel. +49 541 1214-0
Fax +49 541 1214-370
info-instromet-GE4N@honeywell.com
www.elster-instromet.com

Contact

United Kingdom

Elster Metering Limited
Paton Drive
Tollgate Business Park
Beaconside
Stafford, ST16 3EF
Tel. +44 1785 275200
Fax +44 1785 275300
solution.elster@honeywell.com
www.elster-instromet.com

Ireland

Active Energy Control Ltd.
Unit 4, Clare Marts
Quin Road
Ennis, Co. Clare
Tel. +353 65 6840600
Fax +353 65 6840610
info@aec.ie
www.aec.ie