

Eclipse Single-Ended Radiant Tube Burners Models SER450, SER600, SER800

TECHNICAL INFORMATION

Edition 12.18

Version 5

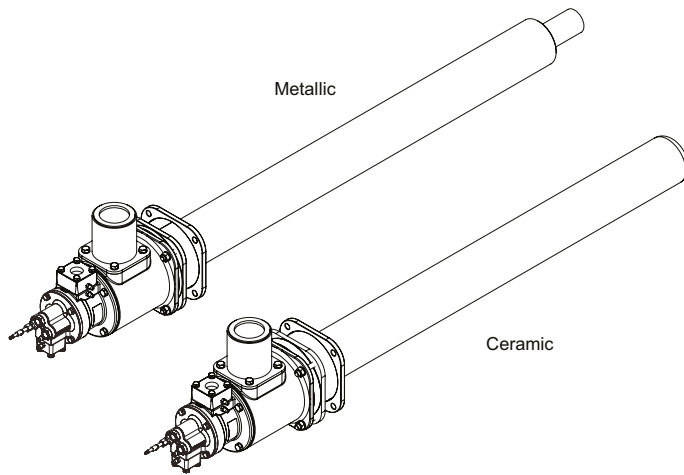

Table of content

Introduction	2
Product Description	2
Audience	2
Purpose	3
SER Documents	3
Safety.....	3
Safety Warnings	3
Operator Training.....	3
Replacement Parts	3
System Design.....	4
Design.....	4
Step 1: Burner Option Selection.....	4
Step 2: Control Methodology.....	7
Step 3: Ignition System	8
Step 4: Flame Monitoring Control System.....	8
Step 5: Combustion Air System:	
Blower & Air Pressure Switch.....	9
Step 6: Main Gas Shut-Off Valve Train	10
Appendix	11
System Schematics	12

Copyright

Copyright 2018 by Honeywell International Inc. All rights reserved worldwide. This publication is protected by federal regulation and shall not be copied, distributed, transmitted, transcribed or translated into any human or computer language, in any form or by any means, to any third parties, without the express written consent of Eclipse, inc.

Disclaimer Notice

In accordance with the manufacturer’s policy of continual product improvement, the product presented in this brochure is subject to change without notice or obligation.

The material in this manual is believed adequate for the intended use of the product. If the product is used for purposes other than those specified herein, confirmation of validity and suitability must be obtained. Eclipse warrants that the product itself does not infringe upon any United States patents. No further warranty is expressed or implied.

Liability & Warranty

We have made every effort to make this manual as accurate and complete as possible. Should you find errors or omissions, please bring them to our attention so that we may correct them. In this way we hope to improve our product documentation for the benefit of our customers. Please send your corrections and comments to our Technical Documentation Specialist.

It must be understood that Eclipse’s liability for its product, whether due to breach of warranty, negligence, strict liability, or otherwise is limited to the furnishing of replacement parts and Eclipse will not be liable for any other injury, loss, damage or expenses, whether direct or consequential, including but not limited to loss of use, income, or damage to material arising in connection with the sale, installation, use of, inability to use, or the repair or replacement of Eclipse’s products.



Any operation expressly prohibited in this manual, any adjustment, or assembly procedures not recommended or authorized in these instructions shall void the warranty.

Document Conventions

There are several special symbols in this document. You must know their meaning and importance.

The explanation of these symbols follows below. Please read it thoroughly.

How To Get Help

If you need help, contact your local Eclipse representative. You can also contact Eclipse at:

1665 Elmwood Rd.
Rockford, Illinois 61103 U.S.A.
Phone: 815-877-3031
Fax: 815-877-3336
<http://www.eclipsenet.com>

Please have the information on the product label available when contacting the factory so we may better serve you.

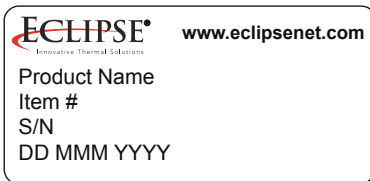

This is the safety alert symbol. It is used to alert you to potential personal injury hazards. Obey all safety messages that follow this symbol to avoid possible injury or death.



Indicates a hazardous situation which, if not avoided, will result in death or serious injury.



Indicates a hazardous situation which, if not avoided, could result in death or serious injury.



Indicates a hazardous situation which, if not avoided, could result in death or serious injury.

NOTICE

Is used to address practices not related to personal injury.

NOTE

Indicates an important part of text. Read thoroughly.

Introduction

Product Description

Eclipse Model SER Single-Ended Radiant Tube Burners incorporate the components of a tube firing burner system in a compact package. The SER burner is a nozzle mixing burner and recuperator coaxially mounted inside a single-ended radiant tube. Combustion air entering the SER burner is preheated in the recuperative section by exhaust gases providing higher efficiencies than stand alone burners. The ceramic combustor yields high efficiency and long life. The insulated exhaust housing and mounting extension keep that working environment cooler and more comfortable. SER burners are available in three diameters (4-1/2", 6", 8") with the radiant tube length tailored to the application. SER burners have the added features of internal flue gas recirculation resulting in lower NOX emissions and ceramic inner tube sections allowing higher flux rates and promoting longer tube life.

Features:

- Direct spark ignition
- Reliable burner operation
- Uniform tube temperature
- Improved tube life
- Simple burner adjustment with integral orifice plates
- Multi-fuel capability

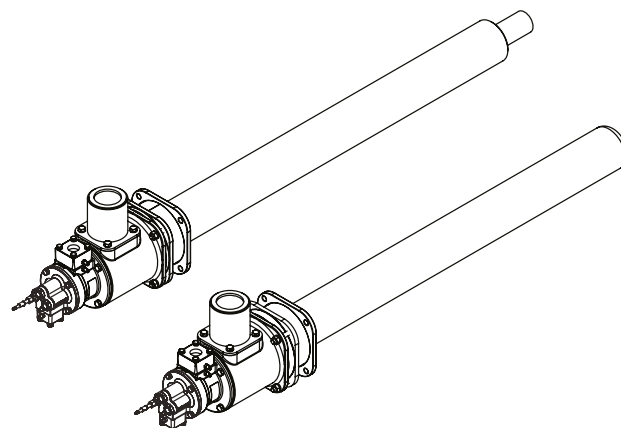

Fig. 1. Single-Ended Radiant Tube Burner

Audience

This manual has been written for people who are already familiar with all aspects of a nozzle-mix burner and its add-on components, also referred to as "the burner system."

These aspects are:

- Design/Selection
- Use
- Maintenance

The audience is expected to have previous experience with this type of equipment.

Purpose

The purpose of this manual is to ensure that the design of a safe, effective, and trouble-free combustion system is carried out.

SER Documents

Technical Information

- This document

SER Datasheet

- Available for individual SER models
- Required to complete design, selection & installation

SER Operating Instructions

- Used with datasheet to complete installation

SER Worksheet

- Required to provide application information to Eclipse Engineering

SER Spare Parts List

- Recommended replacement part information

Related Documents

- Combustion Engineering Guide

Safety

Important notices which help provide safe burner operation will be found in this section. To avoid personal injury and damage to the property or facility, the following warnings must be observed. All involved personnel should read this entire manual carefully before attempting to start or operate this system. If any part of the information in this manual is not understood, contact Eclipse before continuing.

Safety Warnings



DANGER

- The burners covered in this manual are designed to mix fuel with air and burn the resulting mixture. All fuel burning devices are capable of producing fires and explosions when improperly applied, installed, adjusted, controlled or maintained.
- Do not bypass any safety feature; fire or explosion could result.
- Never try to light the burner if it shows signs of damage or malfunction.



WARNING

- The burner is likely to have HOT surfaces. Always wear protective clothing when approaching the burner.
- Eclipse products are designed to minimize the use of materials that contain crystalline silica.

Examples of these chemicals are: respirable crystalline silica from bricks, cement or other masonry products and respirable refractory ceramic fibers from insulating blankets, boards, or gaskets. Despite these efforts, dust created by sanding, sawing, grinding, cutting and other construction activities could release crystalline silica. Crystalline silica is known to cause cancer, and health risks from the exposure to these chemicals vary depending on the frequency and length of exposure to these chemicals. To reduce the risk, limit exposure to these chemicals, work in a well-ventilated area and wear approved personal protective safety equipment for these chemicals.

NOTICE

- This manual gives information for the use of these burners for their specific design purpose. Do not deviate from any instructions or application limits in this manual without written advice from Eclipse.

Capabilities

Only qualified personnel, with good mechanical aptitude and experience with combustion equipment, should adjust, maintain, or troubleshoot any mechanical or electrical part of this system.

Operator Training

The best safety precaution is an alert and trained operator. Train new operators thoroughly and have them demonstrate an adequate understanding of the equipment and its operation. A regular retraining schedule should be administered to ensure operators maintain a high degree of proficiency.

Replacement Parts

Order replacement parts from Eclipse only. Any customer-supplied valves or switches should carry UL, FM, CSA, CGA and/or CE approval where applicable.

System Design

Design

When selecting a SER burner, choices are available to define a burner that will be safe and reliable for the system in which it will be installed. The design process is divided into the following steps:

Step 1: Burner Option Selection

Use the SER Worksheet and Datasheet when following this selection process.

For heat balance calculations, refer to the Combustion Engineering Guide.

Burner Model / Size Selection

Consider the following when selecting the burner size:

- **Heat Input:** Calculate the required heat input to achieve the required heat balance.
- **Power Supply Frequency:** Blower performance is dependent on power supply frequency (50 Hz or 60 Hz power). Size blower properly based on required flow, pressure, and power supply frequency.
- **Altitude:** The maximum burner capacity is reduced by approximately 3% each 1000 feet (300 meters) above sea level.
- **Combustion Air Supply:** Combustion air should be fresh (20.9% O₂) and clean (without particles or corrosives).
- **Fuel Type:** Variation in calorific value and density will affect burner performance. Nominal burner performance is based on fuel properties in Table 1.

Fuel Type

Fuel	Symbol	Gross Heating Value	Specific Gravity
Natural Gas	CH ₄ 90%+	1004 Btu/ft ³ (40 MJ/m ³)	0.60
Btu/ft ³ @ standard conditions (MJ/m ³ @ normal conditions)			

Table 1. Fuel Type

If using an alternative fuel supply, contact Eclipse with an accurate breakdown of the fuel components.

NOTE: Maximum furnace temperature is 1850°F (1010°C).

For furnace temperature higher than 1750°F (954°C), contact Eclipse.

Burner Model & Input Level

Burner input level is determined by radiant tube length, furnace temperature and input required. See sizing example and Figure 5 on page 7. The maximum firing rate is determined and orifices are selected based on model, fuel type and input level.

Burner Length

See individual SER datasheets for burner length dimensional details. Considering the burner length, choose the proper length mounting extension to align the burner nozzle with the furnace hot face.

Outer Tube and Tube Support

NOTICE

- **Version 5 outer tubes have a larger diameter flange than previous versions. Previous version outer tubes cannot be used with the version 5 burners.**

Ceramic or metallic outer tube options are available. The chamber dimensions constrain the outer tube length. See individual datasheets for available tube lengths.

The SER version 5 ceramic outer tubes are designed to be free hanging (or self-supporting) whether they are mounted vertically or horizontally. Extra care should be taken to ensure the ceramic outer tube does not contact any other furnace surface/structure and allow its free movement.

Effective Lengths (mm)	SER 450		SER 600		SER 800	
	Short (185mm)	Long (235mm)	Short (185mm)	Long (235mm)	Short (185mm)	Long (235mm)
800	3	1	-	-	-	-
850	2	2	-	-	-	-
900	1	3	1	3	2	2
950	0	4	0	4	1	3
1000	3	2	3	2	0	4
1050	2	3	2	3	3	2
1100	1	4	1	4	2	3
1150	0	5	0	5	1	4
1200	3	3	3	3	0	5
1250	2	4	2	4	3	3
1300	1	5	1	5	2	4
1350	0	6	0	6	1	5
1400	3	4	3	4	0	6
1450	2	5	2	5	3	4
1500	1	6	1	6	2	5
1550	0	7	0	7	1	6
1600	3	5	3	5	0	7
1650	2	6	2	6	3	5
1700	1	7	1	7	2	6
1750	0	8	0	8	1	7
1800	3	6	3	6	0	8
1850	2	7	2	7	3	6
1900	1	8	1	8	2	7
1950	-	-	0	9	1	8
2000	-	-	3	7	0	9
2050	-	-	2	8	3	7
2100	-	-	1	9	2	8
2150	-	-	0	10	1	9
2200	-	-	3	8	0	10
2250	-	-	2	9	3	8
2300	-	-	1	10	2	9
2350	-	-	0	11	1	10
2400	-	-	3	9	0	11
2450	-	-	2	10	3	9

Table 2. Metallic and Ceramic Outer Tubes

All metallic horizontal tubes longer than 36" (900 mm) need to be supported, see Figure 2. There are three means for providing support.

1. Provide a simple support for the tube from the furnace hearth
2. Cantilever a simple support from the opposite furnace wall
3. Provide an opening in the opposite furnace wall to support an outer tube equipped with a mounting support

Despite the option chosen, a minimum of 3" (75 mm) gap should be left between the end of the tube and the opposite wall or furnace hearth in vertical applications to allow for thermal expansion.

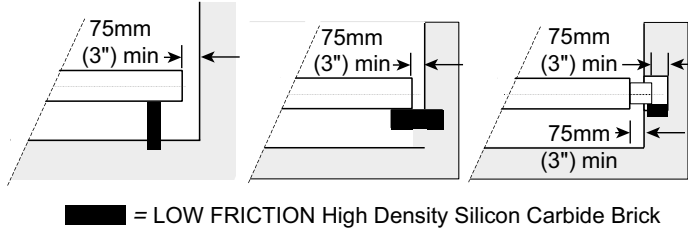

Fig. 2. Metallic Outer Tube Mounting Support

Mounting Extension

Available in 2" to 10" (50 to 250 mm) lengths in 1" (25 mm) increments. Choose extension length with burner length to position the tip of the combustor roughly flush with the furnace hot face up to 1" (25 mm) beyond the hot face. See Figure 3.

$$\text{Burner Length} - \text{Furnace Wall Thickness} - \text{Flange Thickness} = \text{Mounting Extension Length}$$

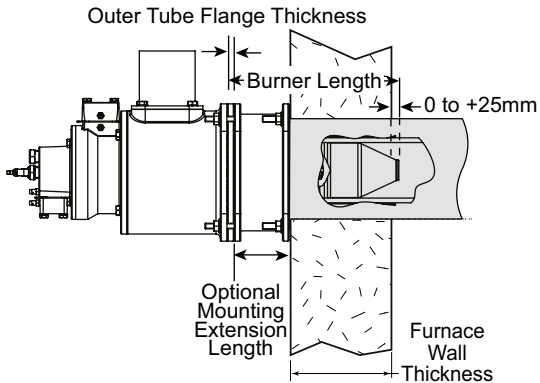

Fig. 3. Mounting Extension Length

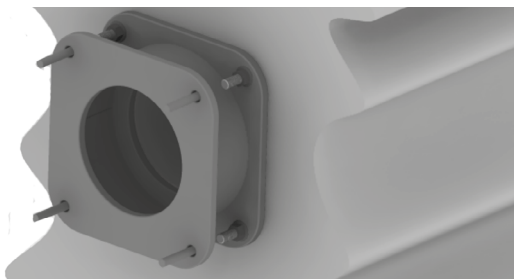

Fig. 4. Mounting Extension furnace wall

The mounting extension is mounted to the furnace wall via customer supplied, threaded studs. See Figure 4. For dimensions see SER Datasheet.

Pipe Connections

Available in BSP and NPT thread standards.



- Call your Eclipse representative to review support methods.

Burner Sizing

$$\text{Max Input} = \frac{\text{Tube Heat Flux} \times \text{Surface Area}}{\text{Tube Efficiency}}$$

SER Burner Sizing Example (US Units):

In our example we know the following:

- Furnace Width/Height: 72"
- Furnace Temperature: 1750°F
- Net Heat Requirement: 2,400,000 Btu/h
- Outer Tube Type/Length: Metallic, Free to Radiate, 69" long (effective)

By referring to Figure 6, the recommended or maximum heat release can be determined. In this example, the safe dissipation rate is 65 Btu/in².

Next Step: How many tubes?

Utilizing 4.5" tubes: 69" x 4.5" x π x 65 Btu/h per in² or 63,400 Btu/h per tube NET release.

If using 6" tubes, the same length tube will provide 84,500 Btu/h net release per tube. The net requirement is 2,400,000 Btu/h for the furnace. Therefore, for 4.5" tubes, 2,400,000 Btu/h net ÷ 63,400 Btu/h net/tube = 38 tubes. With 6" tubes, the number of tubes required would be 28 tubes.

Finally, to size the burner, the gross input is determined. Tube Efficiency is dependent on furnace temperature, tube length, burner length, excess air, etc. In this example, gross-tube efficiency (HHV) is assumed as 0.70. If the calculation shows the maximum gross input is within 10% of the rated capacity of the burner, a more precise determination of efficiency may be required.

For the 4.5" tube burner:

$$\text{Maximum Gross Input} = \text{Net release/tube} \div \text{Gross Tube Efficiency}$$

$$63,400 \text{ Btu/h} \div 0.70 = 90,600 \text{ Btu/h Maximum Gross Input}$$

Determine which number of tubes will best serve the construction and chamber uniformity requirements. Remember to follow the guidelines for safe tube mounting shown in Figure 5. When necessary, adjust the net output per tube if the tubes will be enclosed on three sides as outlined in Figures 5 and 6.

SER Burner Sizing Example (Metric Units):

In our example we know the following:

- Furnace Width/Height: 1825mm
- Furnace Temperature: 950°C
- Net Heat Requirement: 700 kW
- Outer Tube Type/Length: Metallic, Free to Radiate, 1750mm long (effective)

By referring to Figure 6, the recommended or maximum heat release can be determined. In this example, the safe dissipation rate is 30 kW/m².

Next Step: How many tubes?

Utilizing 114mm tubes: 1.750m x 0.114m x π x 30 kW/m² or 18.8 kW per tube NET release.

If using 152mm tubes, the same length tube will provide 25 kW net release per tube. The net requirement is 700 kW for the furnace. Therefore, for 114mm tubes, 700 kW net ÷ 18.8 kW net/tube = 38 tubes. With 152mm tubes, the number of tubes required would be 28 tubes.

Finally, to size the burner, the net input is determined. Tube Efficiency is dependent on furnace temperature, tube length, burner length, excess air, etc. In this example, net tube efficiency (LHV) is assumed as 0.78. If the calculation shows the maximum net input is within 10% of the rated capacity of the burner, a more precise determination of efficiency may be required.

For the 114mm tube burner:

Maximum Net Input = Net release/tube ÷ Net Tube Efficiency

18.8 kW ÷ 0.78 = 24.1 kW Maximum Net Input

Determine which number of tubes will best serve the construction and chamber uniformity requirements. Remember to follow the guidelines for safe tube mounting shown in Figure 5. When necessary, adjust the net output per tube if the tubes will be enclosed on three sides as outlined in Figures 4 and 5.

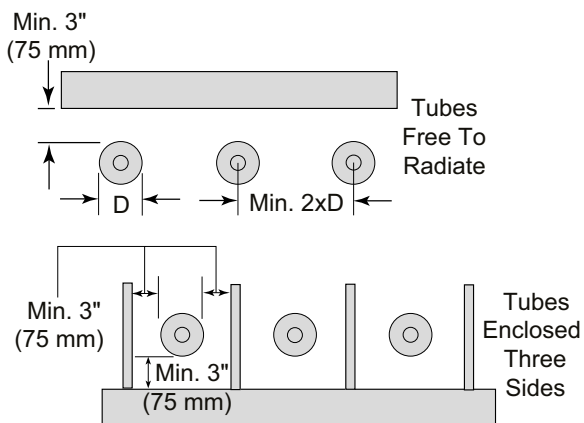

Fig. 5. SER Burner Sizing Example

NOTE: The spacing of the burners should be such that the center line to center line is a minimum of twice the diameter of the outer tube and a minimum of 3” (75 mm) from furnace surfaces (Figure 5).

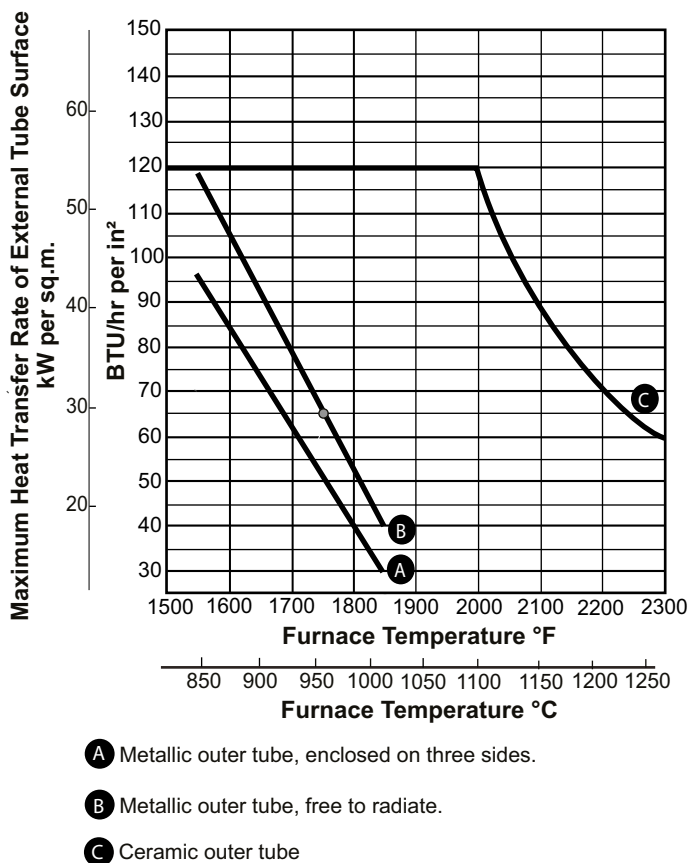

Fig. 6. Recommended Heat Flux

Step 2: Control Methodology

The control methodology is the basis for the rest of the design process.

Once the system is designed, the components can be selected. The control

methodology chosen depends on the requirements of the process.

NOTE: The stated operational characteristics only apply if the described control circuits are followed. Use of different control methods will result in unknown operational performance characteristics. Use the control circuits contained within this section or contact Eclipse Combustion for written, approved alternatives.

Control Method

Eclipse recommends the high/low pulse method to control the input of an SER burner system. The high/low control method is high/low air and gas biased control with excess air at low fire (pulse firing). This method may be applied to single burner as well as multiple burner systems.

In the pages that follow you will find schematics of this control method. The symbols in the schematic are explained in the “Key to System Schematics”, see Appendix.

Modulating control may also be accommodated, contact

Eclipse with details for your application.

NOTE: The following control method does not illustrate flame safety. Flame safety is discussed in Step 4 on page 9 of this guide. Any decisions regarding the use and/or type of flame safety should be made in accordance with local safety and/or insurance requirements.

NOTE: Eclipse recommends using a Kromschroder GIK Regulator on all applications. Use of a different ratio regulator may result in improper burner operation.

High/Low Air & Gas Control

A burner system with high/low control gives a high or low fire input to the process. No input between high and low fire is used.

1. Air

- a. Low Fire: A control input closes the solenoid valve ❶. As a result, the low fire air flows through the bypass line. Low fire air is adjustable via the trim valve ❷.
- b. High Fire: A control input opens the solenoid valve ❶. As a result, the high fire air flows through the main air line.

2. Gas

- a. Low Fire: Low fire is controlled by the proportionator valve ❸.
- b. High Fire: High fire is limited by the manual gas balancing valve ❹.

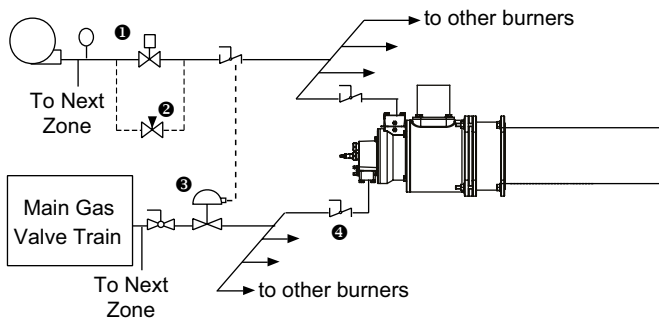

Fig. 7. High/Low Air & Gas Control

If fast high/low control is not necessary, the standard valve u and low fire bypass line ❷ can be replaced with a two-position automatic butterfly valve.

Step 3: Ignition System

For the ignition system use:

- 6,000 VAC transformer
- full-wave spark transformer
- one transformer per burner

DO NOT USE:

- 10,000 VAC transformer
- twin outlet transformer
- distributor type transformer
- half-wave transformer

It is recommended that manual start be used for cold

starts (furnace temperatures below 400°F (204°C)). SER burners are capable of direct spark ignition anywhere within the ignition envelope shown on the appropriate datasheet. See the Installation Guide for detailed start information.

NOTE: You must follow the control circuits described in the previous section, “Control Methodology”, to obtain reliable ignition.

Local safety and insurance require limits on the maximum trial for ignition time. These time limits vary from country to country.

The time it takes for a burner to ignite depends on:

- the distance between the gas shut-off valve and the burner
- the air/gas ratio
- the gas flow at start conditions

Step 4: Flame Monitoring Control System

WARNING

- Flame safety is required when using ceramic outer tubes.

A flame monitoring system consists of two main parts:

- a flame sensor
- flame monitoring control

NOTE: A flame monitoring system may not be required for tube fired burners. According to NFPA 86-2019, combustion safeguards on radiant tube type heating systems are not required where a means of ignition is provided and the systems are arranged and designed such that either of the following conditions are satisfied:

- a. The system is open at one or both ends.
- b. The system is validated explosion resistant.

It is recommended to check your local standards to verify.

Flame Sensor

A UV scanner is used for flame sensing. The UV scanner must be compatible with the flame monitoring control that is used. Refer to the manual of your selected control for proper selection of the scanner.

Flame Monitoring Control

The flame monitoring control processes the signal from the flame sensor and controls the start-up and shut-down sequences.

Flame monitoring controls that stop the spark as soon as a signal is detected may prevent establishment of flame, particularly when using UV scanners. The flame monitoring control must maintain the spark for a fixed time interval that is long enough for ignition.

NOTE: Flame monitoring controls that have low sensitivity flame detecting circuits may limit burner turndown and change the requirements for ignition.

Step 5: Combustion Air System: Blower & Air Pressure Switch

Effects of Atmospheric Conditions

The blower data is based on the International Standard Atmosphere (ISA) at Mean Sea Level (MSL), which means that it is valid for:

- sea level
- 29.92" Hg (1,013 mbar)
- 70°F (21°C)

The make-up of the air is different above sea level or in a hot area. The density of the air decreases, and as a result, the outlet pressure and the flow of the blower decreases. An accurate description of these effects is in the Eclipse Engineering Guide (EFE825). The guide contains tables to calculate the effect of pressure, altitude and temperature on air.

Follow piping practices and recommendations outlined in the Eclipse Engineering Guide (EFE825).

Blower

The rating of the blower must match the system requirements. You can find all the blower data in:

- Bulletin/Datasheet 610

Follow these steps:

1. Calculate the Outlet Pressure

When calculating the outlet pressure of the blower, the total of these pressures must be calculated.

- the static air pressure required at the burner
- the total pressure drop in the piping
- the total of the pressure drops across the valves
- Eclipse recommends a minimum safety margin of 10%
- for good pressure distribution, Eclipse recommends no less than 15" w.c. (37 mbar)

2. Calculate the Required Flow

The blower output is the air flow delivered under standard atmospheric conditions. It must be enough to feed all the burners in the system at high fire.

Combustion air blowers are normally rated in terms of standard cubic feet per hour (scfh) of air.

NOTE: It is common practice to add an additional 10% to 20% of the final blower air flow requirement as a safety margin.

An example calculation is shown below:

Description	Unit of Measure	Formula Symbol
Total system heat input	Btu/hr (kW)	Q
Number of burners	-	-
Type of fuel	-	-
Gross heating value of fuel	Btu/ft ³ (MJ/m ³)	q
Desired excess air percentage (Typical excess air percentage @ high fire is 15%)	percent	%
Air/Gas ratio (Fuel specific, see table below)	-	a
Air flow	scfh (Nm ³ /hr)	V _{air}
Gas flow	scfh (Nm ³ /hr)	V _{gas}

Table 3. Required Calculation Information

Fuel Gas	Stoichiometric* Air/Gas Ratio (V _{air} /V _{gas})	Gross Heating Value q (Btu/ft ³)
Natural Gas (Birmingham, AL)	9.79	1,004 (40MJ/m ³)

*Stoichiometric: No excess air. The precise amount of air and gas are present for complete combustion.

Table 4. Fuel Gas Heating Values

Example Blower Calculation

A furnace has been designed and requires a heat input of 2,400,000 Btu/hr. The burners will operate on natural gas using 15% excess air at high fire.

Calculation Example:

a. Calculate required gas flow:

$$V_{\text{gas}} = \frac{Q}{q} = \frac{2,400,000 \text{ Btu/hr}}{1,004 \text{ Btu/ft}^3} = 2,390 \text{ ft}^3/\text{hr}$$

- Gas flow of 2,390 ft³/hr is required

b. Calculate required stoichiometric air flow:

$$\begin{aligned} V_{\text{air-stoichiometric}} &= \alpha (\text{air/gas ratio}) \times V_{\text{gas}} \\ &= 9.79 \times 2,390 \text{ ft}^3/\text{hr} = 23,398 \text{ ft}^3/\text{hr} \end{aligned}$$

- Stoichiometric air flow of 23,398 scfh required

c. Calculate final blower air flow requirement based on the desired amount of excess air:

$$\begin{aligned} V_{\text{air}} &= (1 + \text{excess air}\%) \times V_{\text{air-stoichiometric}} \\ &= (1 + 0.15) \times 23,398 \text{ ft}^3/\text{hr} = 26,908 \text{ ft}^3/\text{hr} \end{aligned}$$

- For this example, total combustion air flow requirement is 26,908 scfh at 15% excess air. A single blower or multiple blowers could be used depending on the furnace design, the number of zones and burners per zone.

1. Find the blower model number and motor horsepower (hp).

With the outlet pressure and the specific flow, the blower catalog number and motor horsepower can be found in Datasheet 610.

2. Eclipse recommends that you select a totally enclosed fan cooled (TEFC) motor.

3. Select the other parameters:

- inlet filter or inlet grille
- voltage, number of phases, frequency
- blower outlet location, and rotation direction
Clockwise (CW) or Counter Clockwise (CCW).

NOTE: The use of an inlet air filter is strongly recommended. The system will perform longer and the settings will be more stable.

NOTE: When selecting a 60 Hz Blower for use on 50 Hz, a pressure and capacity calculation is required. See Eclipse Engineering Guide.

The total selection information you should now have:

- blower model number
- motor hp, voltage, phase, frequency
- outlet position and rotation direction (CW or CCW)

Air Pressure Switch

The air pressure switch gives a signal to the monitoring system when there is not enough air pressure from the blower. You can find more information on pressure switches in Blower Bulletin 610.



WARNING

- Eclipse supports NFPA and EN regulations, which require the use of an air pressure switch in conjunction with other safety components, as a minimum standard for main gas safety shut-off systems.

Step 6: Main Gas Shut-Off Valve Train

Consult Eclipse

Eclipse can help you design and obtain a main gas shut-off valve train that complies with the current safety standards.

The shut-off valve train must comply with all the local safety standards set by the authorities that have jurisdiction.

For details, please contact your local Eclipse representative or Eclipse.

NOTE: Eclipse supports NFPA regulations (two shut-off valves) as a minimum standard for main gas safety shut-off systems.

Appendix

Conversion Factors

Metric to English

From	To	Multiply By
actual cubic meter/h (am ³ /h)	actual cubic foot/h (acfh)	35.31
normal cubic meter/h (Nm ³ /h)	standard cubic foot /h (scfh)	38.04
degrees Celsius (°C)	degrees Fahrenheit (°F)	(°C x 9/5) + 32
kilogram (kg)	pound (lb)	2.205
kilowatt (kW)	Btu/h	3415
meter (m)	foot (ft)	3.281
millibar (mbar)	inches water column ("w.c.)	0.402
millibar (mbar)	pounds/sq in (psi)	14.5 x 10 ⁻³
millimeter (mm)	inch (in)	3.94 x 10 ⁻²
MJ/Nm ³	Btu/ft ³ (standard)	26.86



Metric to Metric







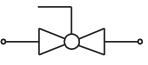
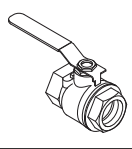
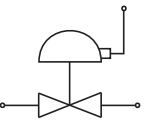
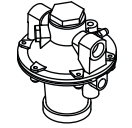
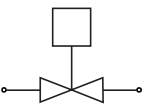
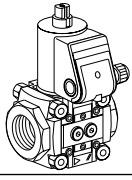

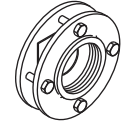
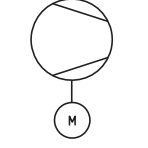
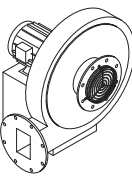
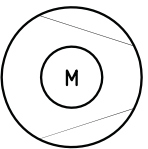
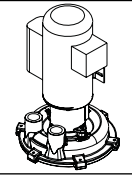
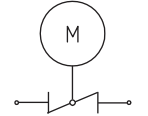
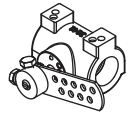

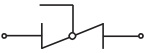
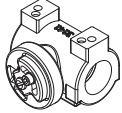

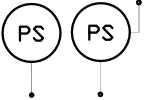

From	To	Multiply By
kiloPascals (kPa)	millibar (mbar)	10
meter (m)	millimeter (mm)	1000
millibar (mbar)	kiloPascals (kPa)	0.1
millimeter (mm)	meter (m)	0.001

English to Metric

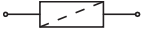
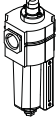
From	To	Multiply By
actual cubic foot/h (acfh)	actual cubic meter/h (am ³ /h)	2.832 x 10 ⁻²
standard cubic foot /h (scfh)	normal cubic meter/h (Nm ³ /h)	2.629 x 10 ⁻²
degrees Fahrenheit (°F)	degrees Celsius (°C)	(°F - 32) x 5/9
pound (lb)	kilogram (kg)	0.454
Btu/h	kilowatt (kW)	0.293 x 10 ⁻³
foot (ft)	meter (m)	0.3048
inches water column ("w.c.)	millibar (mbar)	2.489
pounds/sq in (psi)	millibar (mbar)	68.95
inch (in)	millimeter (mm)	25.4
Btu/ft ³ (standard)	MJ/Nm ³	37.2 x 10 ⁻³

System Schematics

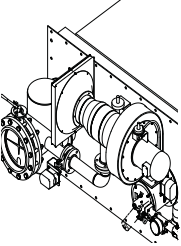
Symbol	Appearance	Name	Remarks
		Gas Cock	Gas cocks are used to manually shut off the gas supply.
		Ratio Regulator	A ratio regulator is used to control the air/gas ratio. The ratio regulator is a sealed unit that adjusts the gas pressure in ratio with the air pressure. To do this, it measures the air pressure with a pressure sensing line, the impulse line. This impulse line is connected between the top of the ratio regulator and the burner body.
Main Gas Shut-Off Valve Train		Main Gas Shut-Off Valve Train	Eclipse strongly endorses NFPA as a minimum
Pilot Gas Shut-Off Valve Train		Pilot Gas Valve Train	Eclipse strongly endorses NFPA as a minimum
		Automatic Shut-Off Valve	Shut-off valves are used to automatically shut off the gas supply on a gas system or a burner.
		Orifice Meter	Orifice meters are used to measure flow.
		Combustion Air Blower	The combustion air blower provides the combustion air to the burner(s)
		Hermetic Booster	Booster is used to increase gas pressure.
		Automatic Butterfly Valve	Automatic butterfly valves are typically used to set the output of the system.

		Manual Butterfly Valve	Manual butterfly valves are used to balance the air or gas flow at each burner.
		Adjustable Limiting Orifice	Adjustable limiting orifices are used for fine adjustment of gas flow.
		Pressure Switch	A switch activated by rise or fall in pressure. A manual reset version requires pushing a button to transfer the contacts when the pressure set point is satisfied.
		Pressure Gauge	A device to indicate pressure.
		Check Valve	A check valve permits flow only in one direction and is used to prevent back flow of gas.
		Strainer	A strainer traps sediment to prevent blockage of sensitive components downstream.
		Flexible Connector	Flexible connectors isolate components from vibration, mechanical, and thermal stresses.
		Heat Exchanger	Heat exchangers transfer heat from one medium to another.
		Pressure Taps	Pressure taps measure static pressure.

For More Information

The Honeywell Thermal Solutions family of products includes Honeywell Combustion Safety, Eclipse, Exothermics, Hauck, Kromschröder and Maxon. To learn more about our products, visit ThermalSolutions.honeywell.com or contact your Honeywell Sales Engineer.

Honeywell Process Solutions

Honeywell Thermal Solutions (HTS)
Eclipse Inc.
1665 Elmwood Rd.
Rockford, IL 61103
United States
T +1 815 877 3031
www.ThermalSolutions.honeywell.com

® U.S. Registered Trademark.
© 2018 Honeywell International Inc.
32-00050-02 M.S. Rev. 12.18
Printed in U.S.A.

The Honeywell logo is displayed in a bold, red, sans-serif font.