

## VQ400M SERIES

### CLASS "A" COMBINATION VALVES

#### INSTRUCTION SHEET

#### APPLICATION

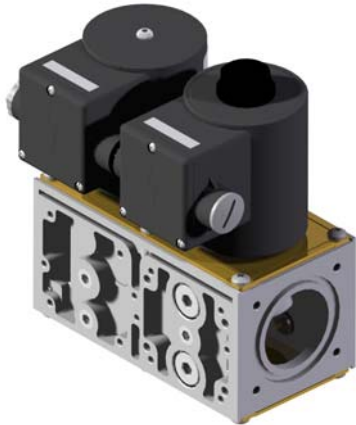

Figure 1 VQ420M & VQ425M

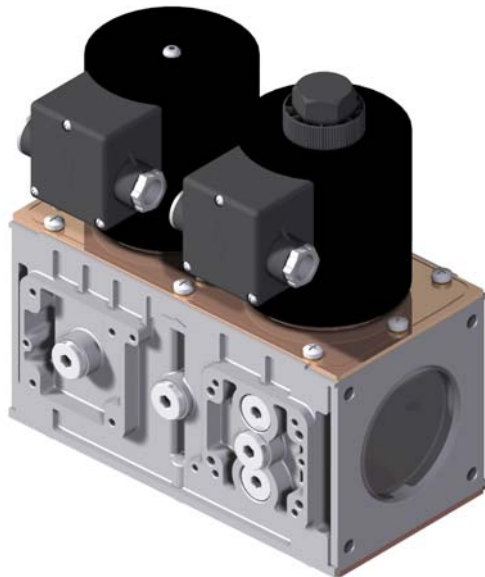

Figure 2 VQ440M & VQ450M

The VQ400M Series class "A" safety combination valves are used for control and regulation of gaseous fluids in gas power burners, atmospheric gas boilers, melting furnaces, incinerators and other gas consuming appliances.

The VQ400M offers flexibility to mount accessories like valve-position indicator, pressure indication switches, vent-valves or by-pass valves at several positions at the gas valve, whenever, wherever.

These combination valves are available in two body sizes:

- Small model
  - VQ420
  - VQ425
- Large model
  - VQ440
  - VQ450

All models are connected at suitable sized gas pipes by flange kits which can be ordered separately in several sizes.

## CONTENTS

VQ400M SERIES .....	1
CLASS "A" COMBINATION VALVES .....	1
APPLICATION .....	1
Contents .....	2
FEATURES.....	2
Dimensions .....	2
Pipe sizes.....	2
Connections.....	3
Ambient temperature range.....	3
Enclosure .....	3
Power consumption .....	3
PERFORMANCE CHARACTERISTICS .....	3
Opening time .....	3
Closing time .....	3
Maximum working frequency.....	4
Operational voltage range .....	4
INSTALLATION .....	4
IMPORTANT .....	4
WARNING.....	4
Maintenance and service.....	4
Mounting position.....	4
Mounting location.....	4
Main gas connection flanged valves .....	5
<b>WARNING!</b> .....	5
Electrical connection.....	5
<b>WARNING</b> .....	5
Wiring PG11 .....	5
Wiring Din plug .....	6
ADJUSTMENTS AND FINAL CHECKOUT .....	6
CAUTION.....	6
2 <sup>nd</sup> main valve fast opening.....	6
2 <sup>nd</sup> main valve slow opening.....	7
IMPORTANT.....	7
Final checkout of the installation .....	8
INSTALLATION of optional valves.....	8
<b>WARNING</b> .....	8
Replacement of parts .....	8
Warning.....	8
Recommended accessories.....	8
APPROVALS.....	10
Declaration of Conformity .....	<b>Error! Bookmark not defined.</b>

## FEATURES

### Dimensions

Main dimensions of the models are given at installation drawings:

**Table 1 Overview of installation drawings.**

Model	Installation drawing
VQ420M	INST0171
VQ425M	INST0172
VQ440M	INST0169
VQ450M	INST0170

Installation drawings are available in Honeywell documentation centre "HotDocs" and can be supplied digitally on request through Honeywell sales representative.

### Pipe sizes

For connecting with several pipe sizes it is recommended to mount Honeywell flange kits which can be ordered separately as indicated below.

**Table 2 Overview of recommended pipe sizes.**

Gas valve	Recommended pipe size	Option
VQ420M	½"	1
VQ420M	¾"	2
VQ425M	1"	
VQ440M	1 ¼"	1
VQ440M	1 ½"	2
VQ450M	2"	

Recommended flanges for each model to be mounted are given in table 10 and table 11.

## Connections

As shown in the figure below, VQ400M is provided with plugs and flanges giving flexibility to customize this combination valve with Honeywell accessories.

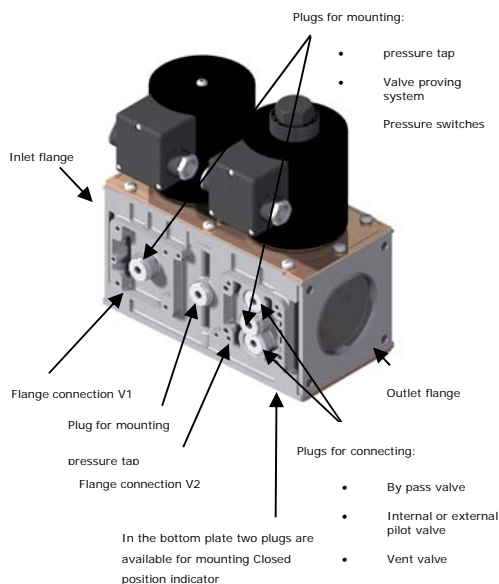

**Table 3 Power consumption of each VQ400M main valve for 360 mbar applications.**

	115V	230V
VQ420M	14	14
VQ425M	18	20
VQ440M	41	48
VQ450M	65	60

## PERFORMANCE CHARACTERISTICS

### Opening time

The first valve (V1) opens in less than 1 second.

The second valve (V2) can be either a fast opening valve which opens in less than 1 second or a characterized opening valve which is adjustable from 1 up to 30 seconds, at rated capacity.

The opening characteristic is factory set at approximately 6 seconds at the following conditions:

- measured at 80 % of rated capacity
- 30 mbar supply pressure
- nominal voltage
- 20 °C
- 2,5 mbar pressure drop
- no step pressure

Due to the influence of ambient temperature (-15 ... 60 °C) the adjusted opening time of 6 seconds measured at 80% of adjusted flow rate can vary +/- 4 seconds.

### Closing time

Less than 1 second for both valves.

### Ambient temperature range

VQ400M is designed to operate in ambient temperature levels between: -15 ... 60 °C

### Enclosure

IP54 in combination with PG11 connection.

IP65 in combination with DIN-plug connection.

### Power consumption

Honeywell provides VQ400M with coils that suit demands of specified inlet pressure levels. An overview of power consumption for different applications is given in the table below.

## **Maximum working frequency**

VQ400M is equipped for maximal working frequency of one cycle per minute.

## **Operational voltage range**

The combination gas valve will function satisfactory between 85% and 110% of the rated voltage.

## **INSTALLATION**

### **IMPORTANT**

1. Read these instructions carefully. Failure to follow the instructions could damage the product or cause a hazardous condition.
2. Check the ratings given in the instructions and on the product to make sure the product is suitable for your application.
3. The installation has to be carried out by qualified personnel only.
4. Carry out a thorough checkout when installation is completed.

### **WARNING**

- Turn off gas supply before installation.
- Disconnect power supply to the valve actuator before beginning the installation to prevent electrical shock and damage to the equipment.
- Do not remove the seal over valve inlet and outlet until ready to connect piping.
- The valve must be installed so that the arrow on the valve points in the direction of the gas flow (gas pressure helps to close the valve).

## **Maintenance and service**

The designed lifetime\* of this product is 10 years, based on date code, according to:

- a) the standard EN 126
- b) the table on designed lifetime as stated on the Afecor website <http://www.afecor.org/>

We cannot assume that the product can be safely used beyond the mentioned designed lifetime. This lifetime is based on use of the control according manufacturer's instructions.

Regular inspection of the control by authorized personnel in accordance with guidelines of the appliance manufacturer is required.

After reaching the designed lifetime the product has to be replaced by authorized personnel.

Note: \* Warranty as opposed to designed lifetime is described in the delivery terms.

## **Mounting position**

The gas valve can be mounted in vertical position with the coils at top side. The gas valve can be mounted plus or minus 90 degrees from the vertical.

## **Mounting location**

The distance between the gas valve and the wall/ground must be at least 30 mm.

## Main gas connection flanged valves

1. Take care that dirt does not enter the gas valve during handling.
2. Remove the flanges from the valve.
3. Use a sound taper fitting with thread according to ISO 7-1 or new, properly reamed pipe, free from swarf.
4. Apply a moderate amount of good quality thread compound to the pipe for fitting only; leaving the two end threads bare, PTFE tape may be used as an alternative.
5. Screw the flanges onto the pipes.
6. Ensure that inlet and outlet flanges are in line and separated from each other enough to allow the valve to be mounted between them without damaging the gasket.
7. Place gasket. If necessary grease it slightly to keep it in place.
8. Mount gas valve between flanges using the bolts for each flange.
9. Complete the electrical connections as instructed in the electrical connection section.

### WARNING!

#### Tightness test after installation

- Spray all pipe connections and gaskets with a good quality gas leak detection spray.
- Start the appliance and check for bubbles. If a leak is found in a pipe connection, remake the joint. A gasket leak can usually be stopped by tightening the mounting screws, otherwise, replace the gas valve.

## Electrical connection

### WARNING

- Switch off power supply before making electrical connections.
- All wiring must comply with local codes, ordinances and regulations.

Use lead wire which can withstand 105 °C ambient.

The electric ON/OFF operator is provided with a terminal block for electrical connections.

### Wiring PG11

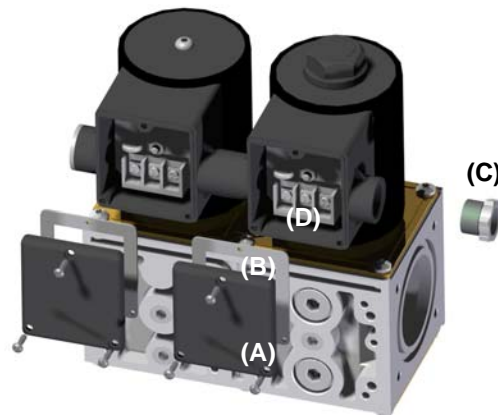

Remove screws (A)

Take off protective cover lids and gaskets (B)

Un-tighten cable support screw (C).

Prepare cable

- Remove plastic outside insulation for about 50 – 75 mm.
- Strip wires from plastic insulation for about 5 – 7 mm.

Place cable in cable support screw and guide wires through the hole in the cover to the connection block (D).

Connect wires between plates by tightening the particular screws (D<sub>1</sub>, D<sub>2</sub>, D<sub>3</sub>).

- Left: phase V1 or V2

- Middle: earth connection
- Right: Neutral

For VQ420M and VQ425M is possible to make connection between the two coils, in that case two wires per connection might need to be connected.

Tighten cable support screw (C).

Place gasket and cover lid in position (B)

Place screws (A) and tighten screws.

### Wiring Din plug

Follow the instructions supplied by the appliance manufacturer as shown in the figures below.

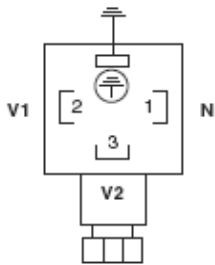

Figure 3 Three pin electrical plug connector (according to ISO 4400).

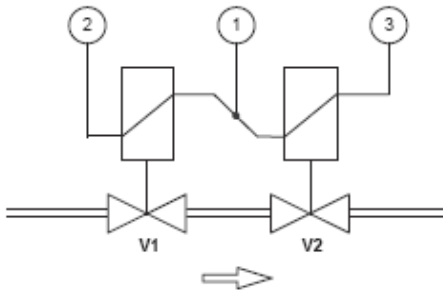

Figure 4 Connection diagram VQ400M

## ADJUSTMENTS AND FINAL CHECKOUT

The procedures described in this chapter are related to the adjustments on the main gas valve, pilot valve and by-pass valve. For adjustments on the other additional functionalities (e.g. pressure switch), refer to the included instruction sheet of the product in question in the package.

### CAUTION

- Adjustments must be made by qualified personnel only.
- To ensure a safe closing of the valves, it is essential that voltage over the terminals of operators is reduced to 0 Volts.

### 2<sup>nd</sup> main valve fast opening

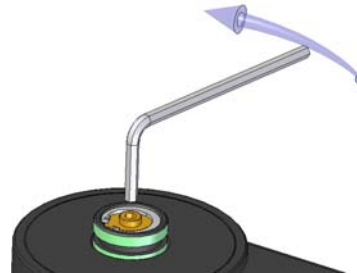

Figure 5 Adjusting flow rate.

Flow rate adjustment (see Fig. 6.)

1. Remove the cap screw from top of the coil.
2. Place a socket head wrench into the adjustment nut.
3. Turn wrench counter-clockwise to increase or clockwise to decrease flow rate.
4. Replace cap screw.

## 2<sup>nd</sup> main valve slow opening

The following characteristics can be adjusted:

- flow rate
- step pressure
- opening speed

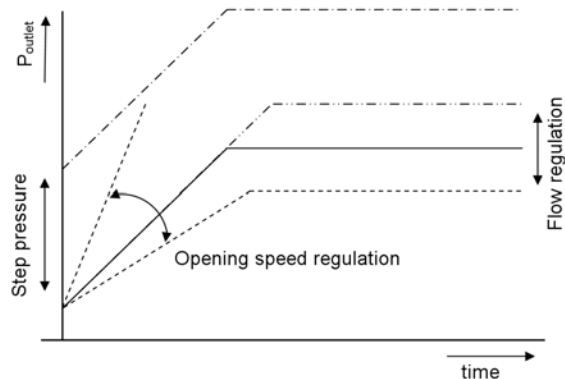

Figure 6 Characterized opening.

## IMPORTANT

To ensure a satisfactory setting of the valve the pressure drop over the valve should be at least 10% of the supply pressure or 2.5 mbar whichever is the greatest.

### Flow rate adjustment

1. Remove the cap from top of the coil by loosening both screws.
2. Place a wrench on the adjustment hexagon nut.
3. Turn wrench counter-clockwise to increase or clockwise to decrease the flow rate.
4. Replace cap on top of the coil.



Figure 7 Adjusting flow rate.

### Step pressure adjustment (see fig. 9.)

1. Remove the cap from top of the coil by loosening both screws.
2. Place a screw driver in the slot of adjustment screw which is situated in center of the valve.
3. Turn screw driver counter-clockwise to increase or clockwise to decrease step pressure.
4. Replace cap on top of the coil.



Figure 8 Adjusting step pressure.

### Opening speed adjustment

1. Remove the cap from top of the coil by loosening both screws.
2. Place screw driver in the slot of adjustment screw which is of center line.
3. Turn screw driver counter-clockwise to increase the opening speed and therefore the time till full opening will decrease.
4. Turn screw driver clockwise to decrease the opening speed and therefore the time till full opening will increase.
5. Replace cap on top of the coil.

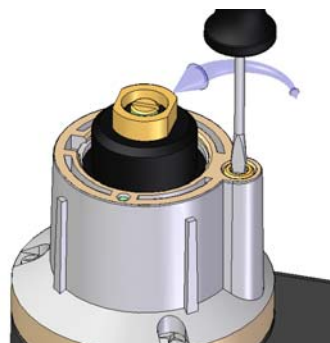

Figure 9 Adjusting opening speed.

## Final checkout of the installation

Set the appliance in operation after any adjustment and observe several complete cycles to ensure that all burner components function correctly.

## INSTALLATION OF OPTIONAL VALVES

Installation can be done by the OEM or by qualified personnel in field.

### WARNING

If additional hardware needs to be installed on field, then installation personnel should take care, that the main gas flow to the appliance has been completely stopped by an upstream manual shut-off valve prior to the installation.

#### Installation

1. Open the required gas flow channels by removing the suitable plugs from the valve body.
2. Take care that dirt can not enter the gas valve during handling
3. Install the screw-in additional hardware as required (vent, by-pass, external pilot valve)
4. Please refer to the relevant instruction sheet

## REPLACEMENT OF PARTS

### Warning

- Take care that only qualified persons carry out the installation of parts, accessories, and add on components.
- Follow the installation instructions included in the package.
- Check that the selected part, accessory or add-on component is the correct one for the application in question.
- Replace old gaskets with the new ones supplied in the package and check for leakage when the supply is switched on again.
- After installation and/or replacement has been completed, a gas leak test must be carried out.
- Also check the gas valve for satisfactory operation after fitting accessories.

## RECOMMENDED ACCESSORIES

There are two different series of flange kits available. The first series of flange kits consist of: 1 flange with sealing plug, 1 O-rings and 4 screws.

**Table 4 Flange kits without strainer.**

Gas valve	Recommended flange kit
VQ420M	KTCOMB15
VQ420M	KTCOMB20
VQ425M	KTCOMB25
VQ440M	KTCOMB32
VQ440M	KTCOMB40
VQ450M	KTCOMB50

The second series of flange kits consist of: 1 flange with sealing plug or cast pressure tap, 1 strainer, 1 O-rings and 4 screws



**Table 5 Flange kits with strainer.**

Gas valve	Recommended flange kit
VQ420M	KTCOMS15
VQ420M	KTCOMS20
VQ425M	KTCOMS25
VQ440M	KTCOMS32
VQ440M	KTCOMS40
VQ450M	KTCOMS50

**Table 6 Overview of recommended internal by-pass valves.**

Gas valve	Internal by pass valve
VQ400M	VB420Xxxxx



See Honeywell documentation VB420Xxxxx KIT for further instructions on internal by-pass valves.

**Table 7 Overview of recommended external pilot valves.**

Gas valve	External pilot valve
VQ400M	VP420Xxxxx



See Honeywell documentation VP420Xxxxx KIT for further instructions on external pilot valves.

**Table 8 Overview of recommended vent valves.**

Gas valve	Vent valve
VQ400M	VV420Xxxxx



See Honeywell documentation VV420Xxxx KIT for further instructions on vent valves.

**Table 9 Overview of characterized opening mechanisms.**

Gas valve	Slow opening mechanism
VQ400M	GF050001



**Table 10 Overview of recommended closed position indication switches (CPI).**

Gas valve	Closed position indicator
VQ420M	MS062001
VQ425M	MS062501
VQ440M	MS064001
VQ450M	MS065001

**Table 11 Honeywell fine particle filter.**

Gasvalve	Honeywell Filter
VQ420M	HFVR050 / HFVR150
VQ425M	



This filter is used to filter fine (50 or 150 µm) particles of dirt out of gas flow.

## STANDARDS AND APPROVALS



THE POWER OF CONNECTED

CE

### EU – Declaration of Conformity

Page 1/1

<b>Branding</b>	<b>Honeywell</b>		
<b>Product</b>	Automatic shut-off valves		
<b>Type &amp; Models</b>	VQ(N)4xx/8xx (a, B, C, D, E, F, G, H, JJ)(A, B, C, D) xxxx VQ(N)4./8.M(A, B, C) xxxx VV420/820, VP420/820, VB420/820 A, B, C xxxx		
<b>Product-ID-Number</b>	CE-0063AR1520		
<b>EU-Acts</b>	2009/142/EC 2016/426/EU 2014/35/EU 2014/30/EU	GAD GAR LVD EMC	Till April 21 <sup>st</sup> 2018 From April 21 <sup>st</sup> 2018  Immunity Emission conformity can only be verified in combination with the appliance
<b>Standards</b>	EN126:2012	Multifunctional Controls	
<b>EU-Type Examination</b>	(EU) 2016/426 Annex III paragraph 1 Kiwa Nederland B.V., Notified Body 0063		
<b>Surveillance Procedure</b>	(EU) 2016/426 Annex III paragraph 3 Kiwa Nederland B.V. Notified Body 0063		

**In our capacity as manufacturer, we hereby declare:**  
Products labelled accordingly meet the requirements of the listed directives, regulations and standards. They correspond to the tested type samples. The production is subject to the stated surveillance procedure. This products comply with the substance restrictions of RoHS II, but they are not in the scope of the directive RoHS II (2011/65/EU). The corresponding operating instructions are included with the product and can be downloaded from:  
<https://products.ecc.emea.honeywell.com/europe/>



2017-11-09

**Manager Standards and Approvals**  
J. Hepping

Honeywell Technologies Sàrl, Z.A. La Pièce, CH-1180 Rolle Switzerland

**Honeywell**

Honeywell Building Technologies

Environmental & Energy Solutions

Honeywell Technologies Sàrl

Z.A. La Pièce 16

1180 Rolle (VD) – CH.