



Flow Computer

Device Type

FC2000

Migration Guide

**How to exchange FC2000 with
enCore FC1 Devices**

Contact

Elster GmbH (manufacturer)

Steinern Straße 19-21

55252 Mainz-Kastel/Germany

Phone: +49 6134 605-0

Email: info@elster.com

Website: www.elster-instromet.com

Technical Support Flow Computers and Gas Analyzers

Phone: +49 231 937110-88

Email: ElsterSupport@Honeywell.com

Website: www.elster-instromet.com

Contents

1	Purpose of this document	4
1.1	Background	4
1.2	Applicability	4
1.3	Target Group	4
1.4	Lists with supported Gas Chromatographs and Ultra Sonic Meters	5
1.4.1	Supported Gas Chromatographs	5
1.4.2	Supported Ultrasonic Flow Meters	6
2	Planning the Migration	7
2.1	Analyzing the current FC2000 Setup and corresponding FC1 options	7
2.1.1	Hardware setup	7
2.1.2	Digital Data Communication	11
2.2	Connection diagrams	13
2.2.1	Turbine meter (EEx i): FC2000 Input module vs. FC1 MFE7 input board	13
2.2.2	HART Measurement Transmitter (EEx i): FC2000 Input module vs. FC1 MFE7 input board	14
3	FAQ	15
3.1	enCore FC manual at a Glance	15
4	Technical Data: FC2000 vs. enCore FC1	16
4.1	General information	16
5	Appendix	18

1 Purpose of this document

1.1 Background

The FC2000 was discontinued on 31.12.2015. At least until end of 2020 Honeywell Elster® provide spare parts, solutions and service, but after that date we can no longer be guarantee that all spare parts are still available.

The next generation Flow Computer enCore FC1 (in short FC1) offers a wide range of functionalities and has proven itself over the last years to be the logical successor for the FC2000. This migration guide aims to assist you to replace a FC2000 with an enCore FC1.

Purpose of this document is to ...

- (1) analyze your current setup (standard configuration only).
- (2) find the requirements for the enCore FC1 (hardware configuration).
- (3) generally, inform how to perform the migration to an enCore FC1 for a standard application.

1.2 Applicability

Due to the complexity of applications and the difference of the devices this document focuses the following standard applications:

- Gas: 1-stream: turbine meter with 1 or 2 flow directions
- Gas: 1-stream: ultrasonic flow meter with 1 or 2 flow directions



Special Honeywell support is necessary for special application requirements

Please contact our ⇔ technical support team directly in case you have special requirements, such as:

- Gas: multi-stream, density or orifice applications
- Liquid applications
- Steam applications
- Wet gas applications
- Station controller applications
- Liquid prover

This document focuses on the hardware setup and does not describe the parameterization nor the operation of the devices.

Honeywell Elster® will offer a special software configuration service and an on-site migration service. Please contact your local Honeywell Service team for further details.

1.3 Target Group

This migration guide is directed to people dealing with reinvestigation and qualified electricians in the fields of switch cabinet construction and maintenance, as well as qualified field and service personnel with specialized knowledge in device assembly and commissioning.



Before you start – knowledge of the enCore FC1 is mandatory!

The approach of the FC2000 and enCore FC1 differ greatly. Therefore, readers of this document should not only know how flow computers work and how gas is measured in general, but also be familiar with the modular hardware and software design of enCore devices, its mounting, commissioning, parameterization and maintenance.

Honeywell Elster® offers general trainings regarding industrial gas metering and special trainings for the Flow Computer enCore FC1. (⇒ section 4.1 [enCore FC manual at a Glance](#), p. 15)

If required, please contact your local sales representative:

<https://www.elster-instromet.com/en/sales-contacts>

1.4 Lists with supported Gas Chromatographs and Ultra Sonic Meters

The enCore FC1 does not support all gas chromatographs (GCs) and Ultrasonic Gas Meters (USMs) that are supported by the FC2000. Please check the following lists carefully!

1.4.1 Supported Gas Chromatographs

GCs by	Modell	FC2000	enCore FC
ABB	8000/8100 resp. 8000/8100S	✓	✓
	3100	✓	–
	8200	–	✓
Daniels	2251	✓	✓
	2350	✓	✓
	2551	✓	✓
	2551 – C7	✓	–
Elster Instromet	enCal 2000	✓	–
	enCal 3000	✓	✓
	enCal (India Software)	✓	–
	enSonic	✓	–
	M2000 (GC emulation mode)	✓	–
	Station Controller 793-7SC	✓	–
	enCal US Model	✓	–
Rosemount	GCX	✓	–
Siemens	Optichrome	✓	–
	Maxum 2	✓	–
	Sitrans C6	–	✓
	Sitrans C9	–	✓
Yamatake	HGC303	✓	–
Yokogawa	G1000 MARK II	✓	–

Tabelle 1-1: Supported GCs

1.4.2 Supported Ultrasonic Flow Meters

USMs by	Modell	FC2000	enCore FC
Caldon	LEFM380Ci	–	✓
Daniels	Senor Sonic	✓	✓
Elster Instromet	Ultrasonic resp. Q.Sonic	✓	✓
	Q.Sonic plus/Q.Sonic max	✓	✓
DigitalFlow	Panametrics GM868	✓	–
	Panametrics IGM878	✓	–
Krohne	Altosonic V12	–	✓
	Altosonic V12 – Modicon compatible	–	✓
RMG	USZ08	–	✓
Sick	FLAWSIC 100	✓	–
	FLAWSIC 500	–	✓
	FLAWSIC 600	✓	✓

Tabelle 1-2: Supported USMs



The FC1 does not support *thru-port* functionality directly



In case you are using thru-port functionality with the FC2000, you need to use an external converter like an Adam-4520 in combination with the FC1.

2 Planning the Migration



2.1 Analyzing the current FC2000 Setup and corresponding FC1 options

2.1.1 Hardware setup

Housing

FC2000 configuration	⇒ Options for the FC1
<p>□ 1/2-unit 19" rack</p> <ul style="list-style-type: none"> • dimension w/o connectors: 128.5×213×235 mm (H×W×D) • max. no. of boards: 5 <div data-bbox="331 719 855 1301" style="border: 1px solid gray; padding: 5px;"> <p> The housing of the FC2000 is deeper than enCore FC1! Therefore, all wires on FC2000 should have a reserve length of 20cm.</p>  <p>Fig. 2-1: FC2000 is deeper than an FC1</p> </div>	<p>– 1/2-unit 19" rack</p> <ul style="list-style-type: none"> • dimension w/o connectors: 128.5×213×170 mm (H×W×D) • max. no. of boards: 7 <div data-bbox="916 719 1437 801" style="border: 1px solid gray; padding: 5px;"> <p> For a 1:1 migration we recommend the use the enCore FC1 in 1/2-unit width.</p> </div> <p>– 1/3-unit 19" rack</p> <ul style="list-style-type: none"> • dimension w/o connectors: 128.5×142×170 mm (H×W×D) • max. no. of boards: 4

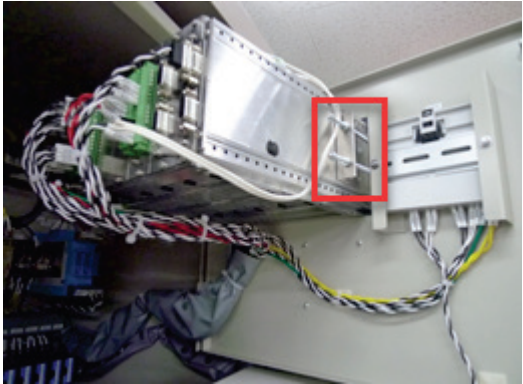
Mounting

FC2000 configuration	⇒ Options with the FC1
<input type="checkbox"/> 19" mounting frame for FC2000 (for 2 × 1/2-units)	<ul style="list-style-type: none"> – 19" rack for cabinet mounting an enCore FC (for 2×1/2-units or 3×1/3-units) <div style="border: 1px solid gray; padding: 5px; margin-top: 10px;"> <p> The depth of the 19" racks of FC2000 and FC1 differs! Without connectors, the FC has a depth of 170 mm and the FC2000 235 mm.</p> </div>
<input type="checkbox"/> panel mounting with mounting brackets  <p>Fig. 2-2: 2 × mounting brackets screwed directly to both sides of the FC2000 (in the predrilled holes provided for this purpose)</p>	<ul style="list-style-type: none"> – Please contact Elster in this case. – 19" rack for enCore FC devices (without mounting brackets) <div style="border: 1px solid gray; padding: 5px; margin-top: 10px;"> <p> The FC1 housing does not provide predrilled holes for the mounting brackets.</p> </div>
	<ul style="list-style-type: none"> – additionally, the FC1 supports wall mounting housing (only for 1/3-unit)  <p>Fig. 2-3: Wall mounting housing for 1/3-unit</p>

Standard applications – modules used







Please note that the boards used for FC2000 and enCore FC device series vary regarding the available interfaces.

In general:

FC2000 modules for standard applications	⇒ Options with the FC1
<input type="checkbox"/> Turbine gas meter – 1 or 2 flow direction(s) 1 × MPU 1 × PSU 1 × Input (2) 1 × Output	– Turbine meter – 1 or 2 flow direction(s): 1 × CPU3 1 × MFE7 1 × MFA8
<input type="checkbox"/> Ultrasonic flow meter – 1 or 2 flow direction(s): 1 × MPU 1 × PSU 1 × Input (2) 1 × Comms 1 × Output board	– Ultrasonic flow meter – 1 or 2 flow directions: 1 × CPU3 1 × MFE7 1 × MFA8

Modules/boards in detail:

FC2000 modules in detail	⇒ Options with the FC1
<p><input type="checkbox"/> PSU and MPU</p> <p>PSU: 1 × Power supply input nominal +24 V DC (21 to 28 C VD) 1 × auxiliary output supply +24VDC (fused)</p> <p>MPU: 2 × DSUB9 female (isolated RS232, RS485 serial channels)</p> <p> Ethernet connector available only in additional Network 2 module.</p>	<p>⇒ Options with the FC1</p> <p>– CPU3</p> <p>1 × Power supply input nominal +24 V DC (20.4 to 28.8 C VD)</p> <p>2 × RJ45 style (RS232, RS485, RS422 serial channels) 1 × Ethernet connector (LAN)</p> <p> Unlike the PSU, the CPU3 has <i>no</i> power output.</p>
<p><input type="checkbox"/> Input module/Input 2 module</p> <p>2 × HART inputs (3 transmitters each) 4 × current inputs 4..20mA (24 bit) 1 × Pt100 (3-wire) 3 × digital status inputs 2 × HF inputs 1 × prover pulse output (<i>Input 2 module only</i>)</p>	<p>– MFE7 input board (<i>preferred</i>)</p> <p>3 × digital input for HF/LF/Encoder/Message 1 × input for Pt100 (4-wire) 2 × analog inputs 4..20mA or HART (up to 4 transmitter each depending on manufacturer) 1 × RS485 serial interface (RSA/RSE/GND)</p> <p>– ExMFE5 intrinsically safe input board</p> <p>3 × NAMUR input [Ex ib Gb] IIC for HF/LF/Encoder/Message 1 × input for Pt100 [Ex ib Gb] IIC (4-wire) 1 × analog inputs 4..20mA or HART or HART (up to 4 transmitter each depending on manufacturer)</p> <p> ExMFE5 Safety Notices</p> <p>Only transmitters and pulse sensors that follow at least the requirements of the intrinsically safe protection class [Ex ib Gb] II C may be connected to the ExMFE5 assembly terminals provided for that purpose. A mixed connection of intrinsically safe and non-intrinsically safe circuits is not permitted for these assemblies.</p>
<p><input type="checkbox"/> Comms module</p> <p>2 × DSUB9 female (isolated RS232, RS485 serial channels)</p>	<p>– ESER4</p> <p>1 × Ethernet connector (LAN) 3 × RJ45 style (RS232, RS485, RS422 serial channels)</p>
<p><input type="checkbox"/> Output module</p> <p>12 × isolated switching outputs 4 × analog outputs 0/4..20 mA</p>	<p>– MFA8 output board</p> <p>1 × PhotoMos output (NC, max. 28.8 V, 120 mA) 3 × PhotoMos outputs (NO, max. 28.8 V DC, 120 mA) 4 × analog outputs 0/4..20 mA</p> <p> In case all digital outputs of the FC2000 Output module are in use, the FC1 must be equipped with 3×MFA8 boards.</p>

Network boards

FC2000 configuration	⇒ Options with the FC1
<input type="checkbox"/> Network 2 module 1 × Ethernet connector (LAN)	<ul style="list-style-type: none"> – CPU3 (<i>default board</i>) 1 × Ethernet connector (LAN) – ESER4 (<i>optional</i>) 1 × Ethernet connector (LAN) 3 × RJ45 style (RS232, RS485, RS422 serial channels) <div style="border: 1px solid gray; padding: 5px; margin-top: 10px;">  For 1/3-unit 1×ESER4 board can be installed in slot 4 only; for 1/2-unit up to 2×ESER4 boards can be installed in slots 6 and 7. </div>

External options

FC2000 configuration	⇒ Options with the FC1
<input type="checkbox"/> Counter module 1..4 counter	<ul style="list-style-type: none"> – (<i>not supported</i>)
<input type="checkbox"/> Ink printer module	<ul style="list-style-type: none"> – (<i>not supported</i>) The FC2000 printer unit is technically outdated and can be unmounted. In the FC1 this functionality is realized with a more powerful Printer AFB which can print on either a network or serial printer.

2.1.2 Digital Data Communication

Data communication is independent of the standard application used.

Modbus

FC2000 configuration	⇒ Options with the FC1
<input type="checkbox"/> Modbus (ASCII, RTU) via serial RS232/RS485 communication (MPU or Comms module)	<ul style="list-style-type: none"> – Modbus (ASCII, RTU) via serial RS232/RS485 communication and additionally RS422 (serial channels of CPU or ESER4) Master and Slave operation mode <div style="border: 1px solid gray; padding: 5px; margin-top: 10px;">  Latching of registers is not supported by the FC1. </div>
<input type="checkbox"/> Modbus TCP via a standard TCP/IP network (LAN of Network 2 module)	<ul style="list-style-type: none"> – Modbus TCP via a standard TCP/IP network (LAN of CPU or ESER4) Server and Client operation mode

Remote front panel access

	FC2000 configuration	⇒ Options with the FC1
Name	"Remote front panel access"	"Remote operation panel"
Data protocol	<ul style="list-style-type: none"> HTTP 	<ul style="list-style-type: none"> Currently HTTP, planned to switch to secured MMS
Prerequisite	active connection between PC and FC2000... <ul style="list-style-type: none"> via LAN (Ethernet 2 module) 	active connection between PC and FC1 ... <ul style="list-style-type: none"> via network (LAN of CPU or ESER4), or locally via USB connection
Access	<ul style="list-style-type: none"> via web browser (e.g. Microsoft Edge) using the IP address of the device 	<ul style="list-style-type: none"> currently via web browser (e.g. Microsoft Edge) using the IP address of the device (outdated) via enSuite

Connection between Service PC and device (e.g. for parameterization)

Connection	FC2000	⇒ Options with the FC1
locally	<ul style="list-style-type: none"> via USB Type A on Type A (male) 	<ul style="list-style-type: none"> USB Type A on Type B
via network	<ul style="list-style-type: none"> via LAN if Ethernet 2 module is installed 	<ul style="list-style-type: none"> via LAN of CPU or ESER4

Retrieving archives

FC2000 configuration	⇒ Options with the FC1
<input type="checkbox"/> via Modbus	– via Modbus
<input type="checkbox"/> via M2000 configuration software	– via enSuite
	– additionally, directly via operation panel

2.2 Connection diagrams

This section shows technical drawings on how turbine and ultrasonic flow meters are connected to an FC2000 and how the connections look like for an FC1.

2.2.1 Turbine meter (Ex i): FC2000 Input module vs. FC1 MFE7 input board

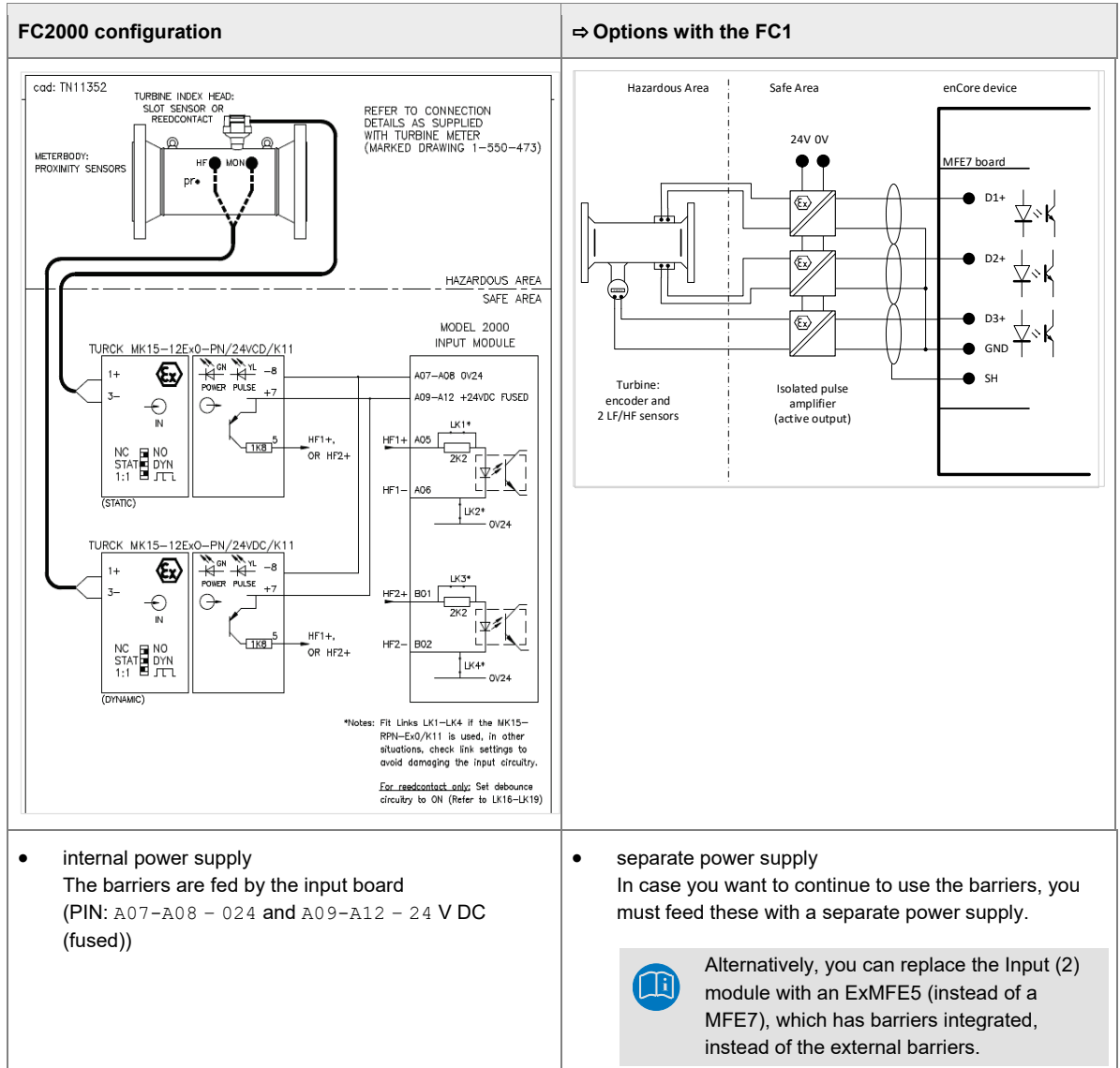

2.2.2 HART Measurement Transmitter (EEx i): FC2000 Input module vs. FC1 MFE7 input board

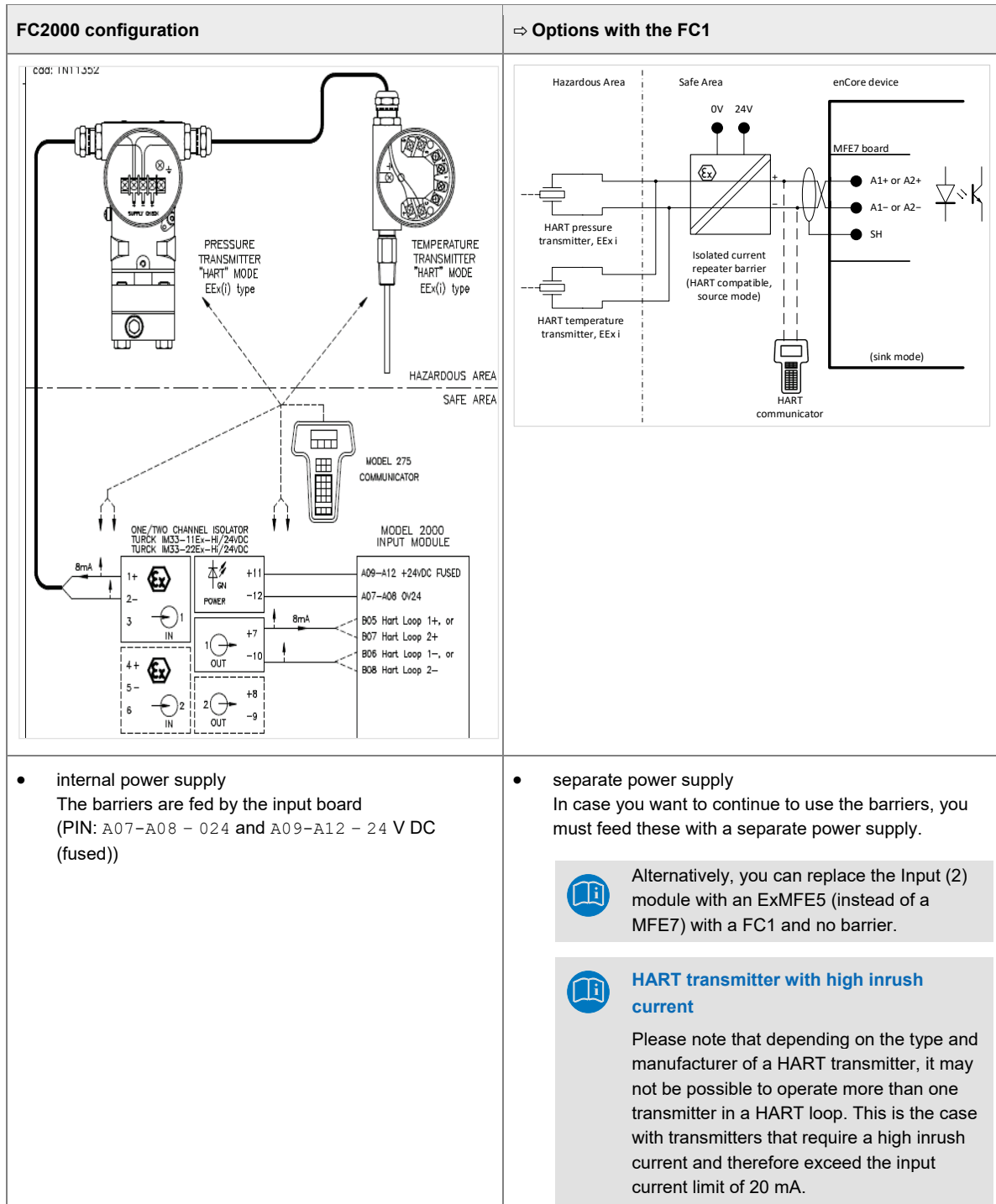

3 FAQ

3.1 enCore FC manual at a Glance

The manual for the enCore FC device series is modular. It consists of the following volumes:

- “Instructions for Use in Legal Metrology”
This volume focuses on the legally relevant properties and functions of the FC1 flow computer.
- “Operating Instructions”
This volume describes the assembly, installation, commissioning and maintenance of all enCore FC devices.
- “Configuration of Device Software”
This volume describes parameterizing devices of the enCore series with the software system enSuite, the software download and further services.
- “Basic System with SFBs”
This volume describes the basic system, which provides all basic functions of the device software. The basic system e.g. manages the system resources, the I/O boards or the connection to other devices via digital protocols.
- Functionality of individual **A**pplication **F**unction **B**locks (AFBs)
Each volume describes the parameterization, function and operation of each AFB. These volumes always describe the full range of functions of the respective AFBs.

In our docuthek you can download the latest versions of our manuals:

www.docuthek.com

4 Technical Data: FC2000 vs. enCore FC1

4.1 General information

	FC2000	enCore FC1												
Housing/dimensions	<p>available in 1 width:</p> <ul style="list-style-type: none"> 1/2 width plug-in unit in 19" design, 3U dimensions w/o connectors: 128.5×213×235 mm (H×W×D) dimensions with connectors (approx.): 128.5×213×255 mm (H×W×D) 	<p>available in 2 widths:</p> <ul style="list-style-type: none"> 1/2 width plug-in unit in 19" design, 3U dimensions w/o connectors: 128.5 × 213 × 170 mm (H×W×D) dimensions with connectors (approx.): 128.5 × 213 × 220 mm (H×W×D) 1/3 width plug-in unit in 19" design, 3U: dimensions w/o connectors: 128.5 × 142 × 170 mm (H×W×D) dimensions w connectors (approx.): 128.5 × 142 × 220 mm (H×W×D) 												
Weight	<p>(fully equipped)</p> <ul style="list-style-type: none"> 1/2-unit width: approx. 2.5 kg 	<p>(fully equipped)</p> <ul style="list-style-type: none"> 1/3-unit width: approx. 1.3 kg 1/2-unit width: approx. 2.1 kg 												
Ambient conditions	<ul style="list-style-type: none"> ambient temperature range: 0 °C up to +60 °C humidity < 90 %, non-condensing installation outside Ex zones 0, 1 and 2 only 	<ul style="list-style-type: none"> ambient temperature range -10 °C up to +55 °C humidity < 90 %, non-condensing installation outside Ex zones 0, 1 and 2 only 												
Calibration/security switch	<ul style="list-style-type: none"> on the left side 	<ul style="list-style-type: none"> on the front 												
USB parameter cable	<ul style="list-style-type: none"> Type A (both sides) 	<ul style="list-style-type: none"> Type A and type B 												
IrDA parameter interface	<ul style="list-style-type: none"> Only for devices of the early device series 													
Communication ports:														
RS232	<ul style="list-style-type: none"> CPU- and Comms module: DSUB9 female, grounded shield not connected <p><u>Pin assignment:</u></p> <table> <tr> <td>RxD</td> <td>pin 2</td> </tr> <tr> <td>TxD</td> <td>pin 3</td> </tr> <tr> <td>SGND</td> <td>pin 5</td> </tr> </table>	RxD	pin 2	TxD	pin 3	SGND	pin 5	<ul style="list-style-type: none"> CPU3 and ESER4: RJ45 style, grounded shield connected <p><u>Pin assignment:</u></p> <table> <tr> <td>RxD</td> <td>pin 3</td> </tr> <tr> <td>TxD</td> <td>pin 1</td> </tr> <tr> <td>SGND</td> <td>pin 5</td> </tr> </table>	RxD	pin 3	TxD	pin 1	SGND	pin 5
RxD	pin 2													
TxD	pin 3													
SGND	pin 5													
RxD	pin 3													
TxD	pin 1													
SGND	pin 5													
RS485	<ul style="list-style-type: none"> CPU- and Comms module: DSUB9 female, grounded shield not connected <p><u>Pin assignment:</u></p> <table> <tr> <td>line A</td> <td>pin 9</td> </tr> <tr> <td>line B</td> <td>pin 6</td> </tr> </table>	line A	pin 9	line B	pin 6	<ul style="list-style-type: none"> CPU3 and ESER4: RJ45 style, grounded shield connected <p><u>Pin assignment:</u></p> <table> <tr> <td>data A</td> <td>pin 1</td> </tr> <tr> <td>data B</td> <td>pin 2</td> </tr> </table> <ul style="list-style-type: none"> MFE7: serial interface (RSA/RSB/GND) <p><u>Pin assignment:</u></p> <table> <tr> <td>data A</td> <td>RSA</td> </tr> <tr> <td>data B</td> <td>RSB</td> </tr> </table>	data A	pin 1	data B	pin 2	data A	RSA	data B	RSB
line A	pin 9													
line B	pin 6													
data A	pin 1													
data B	pin 2													
data A	RSA													
data B	RSB													

RS422	/	<ul style="list-style-type: none">• CPU3 and ESER4: RJ45 style, grounded shield connected Pin assignment: data A pin 1 data B pin 2
-------	---	---

5 Appendix

- enCore FC1 Product Ordering Sheet V1

Customer: _____ Order Number: _____ Date: _____

Options		Configuration (Standard is bold)
Basic Device	Housing size	<input type="checkbox"/> 1/2 19" Rack <input type="checkbox"/> 1/3 19" Rack
	Mode Stream 1	<input type="checkbox"/> Turbine 1 Flow Direction (connected via pulses) <input type="checkbox"/> Turbine 2 Flow Direction (connected via pulses) <input type="checkbox"/> Ultrasonic 1 Flow Direction (connected via protocol) <input type="checkbox"/> Ultrasonic 2 Flow Direction (connected via protocol)
	Mode Stream 2	<input type="checkbox"/> Turbine 1 Flow Direction (connected via pulses) <input type="checkbox"/> Turbine 2 Flow Direction (connected via pulses) <input type="checkbox"/> Ultrasonic 1 Flow Direction (connected via protocol) <input type="checkbox"/> Ultrasonic 2 Flow Direction (connected via protocol)
	Additional I/O Boards	Max. number of boards in 1/2 size is 7; in 1/3 size is 4 <input type="checkbox"/> ExMFE5, Number ____ <input type="checkbox"/> MFE7, Number ____ <input type="checkbox"/> MFA8, Number ____ <input type="checkbox"/> ESER4, Number ____ (max. 2)
Test	Calibration	<input checked="" type="checkbox"/> factory calibration <input type="checkbox"/> MID (transmitters needed) <input type="checkbox"/> function tested
Installatio	Installation	<input type="checkbox"/> None <input type="checkbox"/> 19" mounting frame <input type="checkbox"/> Wall mounting kit (small housing)
Comm.	Modem	<input type="checkbox"/> None <input type="checkbox"/> UMM (Universal Mobilfunk Modem – GPRS/UMTS Router)

Customer: _____ Order Number: _____ Date: _____

Options		Configuration (Standard is bold)
Pressure Transmitter	Honeywell STA84LB Basic	<input type="checkbox"/> Pressure Range 0,9 - 6 Bara <input type="checkbox"/> Pressure Range 1,75 - 35 Bara
	Honeywell STA87LB Basic	<input type="checkbox"/> Pressure Range 20 - 100 Bara
	Honeywell STA84LB Extra	<input type="checkbox"/> Pressure Range 0,9 - 6 Bara (higher accuracy + Display) <input type="checkbox"/> Pressure Range 1,75 - 35 Bara (higher accuracy + Display)
	Honeywell STA87LB Extra	<input type="checkbox"/> Pressure Range 20 - 100 Bara (higher accuracy + Display)
Temperature Transmitter	Jumo PT100 (4 wire)	Built in length (EBL) <input type="checkbox"/> EBL 50 <input type="checkbox"/> EBL160 <input type="checkbox"/> EBL 250
	Honeywell STT850 (HART)	<input type="checkbox"/> EBL 50 <input type="checkbox"/> EBL160 <input type="checkbox"/> EBL 250

Project / Reference / Comments:

Customer: _____

Contact Person: _____

Tel.: _____ E-Mail: _____