

Eclipse ImmersoPak Burners

Model IP010

Data sheet Edition 09.18

Version 3

Parameter	Modulating Air (Control Option 2)		
	Natural Gas	Propane	Butane
Maximum Input, kBtu/h (kW)	2750 (805)	2600 (762)	2550 (748)
Low Firing Rate x 1000 Btu/h (kW)	100 (30)	100 (30)	100 (30)
High Fire CO, ppm	< 10	< 10	< 10
Orifice Size, mm	21.6	18.0	16.0
Air Inlet Pressure at Maximum Input, "w.c. (mbar) Air pressure at burner inlet (Tap A)	10 (25)		
Main Gas Inlet Pressure, "w.c. (mbar)	Maximum	75 (187)	
	Minimum	15 (37.4)	
	Recommended	18 (44.8)	
Weight - less actuator, lbs (kg)	164 (74)		
Blower Type	15" Packaged		
Piping	NPT or BSP		
Flame Detection	UV Scanner		
Approvals	EAC		

- All information is based on laboratory testing with a 12" diameter tube effective length of 39.1 feet (11.9 m). Different tube sizes and conditions (including back pressure) may affect the data.
- All information is based on standard tube design. Changes in the tube will alter performance and pressures.
- All inputs based upon gross calorific values.
- Plumbing of air and gas will affect accuracy of orifice readings. All information is based on generally acceptable air and gas piping practices.
- For 65% to 80% efficiency at high fire, tube length should be 30 to 75 feet long.
- See Design Guide 360 for more information about typical fuel composition and properties
- Eclipse reserves the right to change the construction and/or configuration of our products at any time without being obliged to adjust earlier supplies accordingly.

Performance Graphs

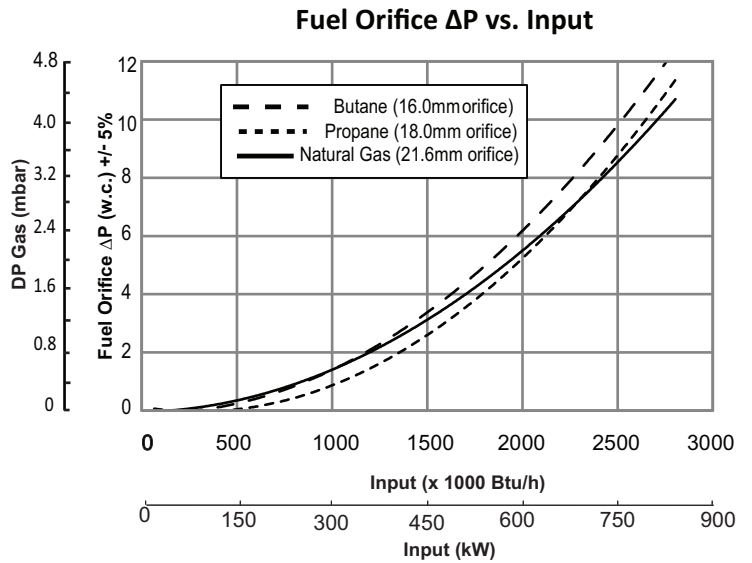
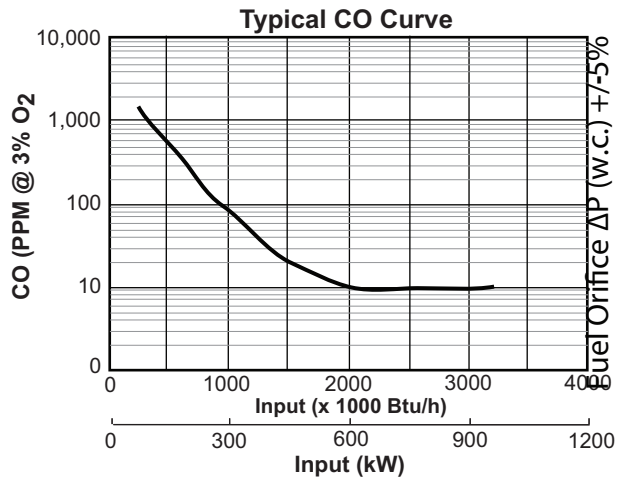
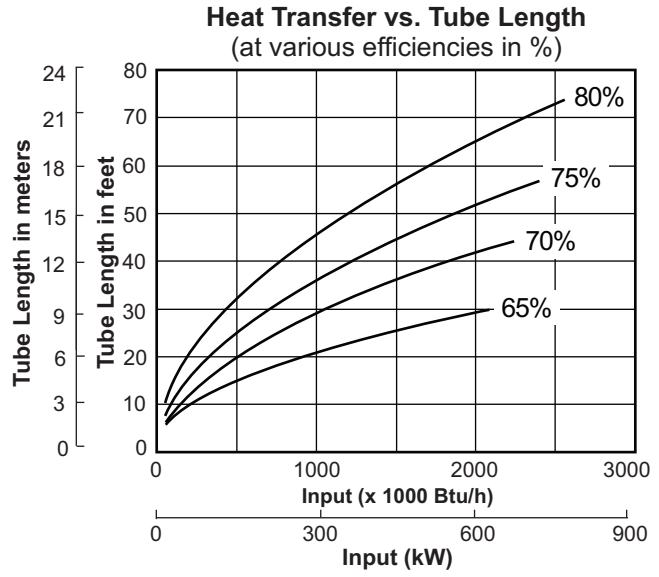
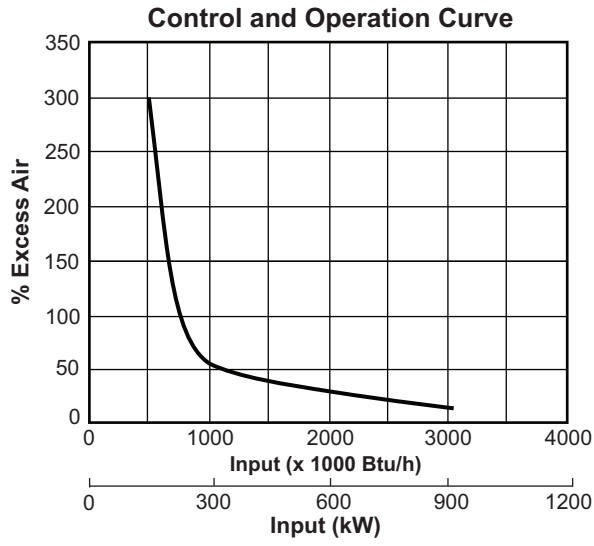

Dimensions and Specifications

Dimensions in mm (inches)

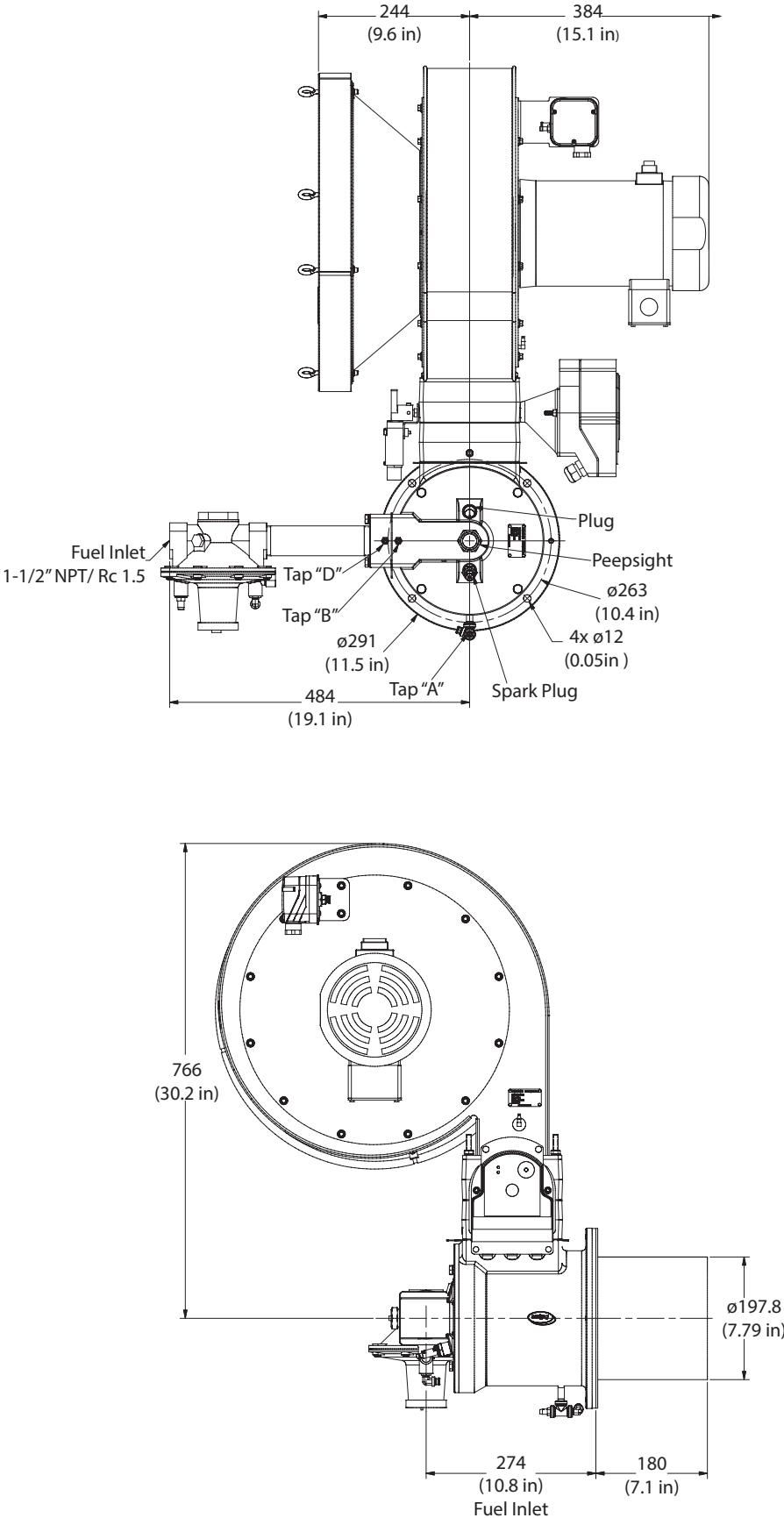

Burner Configurations

Upright

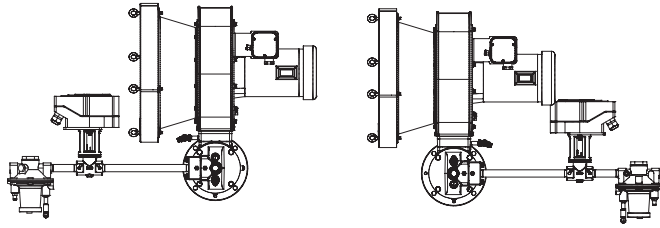

Left Hand Piping

Right Hand Piping

Inverted

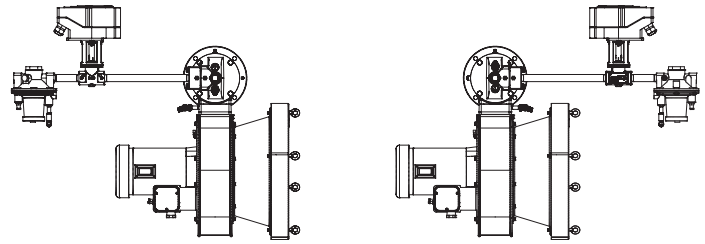

Left Hand Piping

Right Hand Piping

For More Information

The Honeywell Thermal Solutions family of products includes Honeywell Combustion Safety, Honeywell Combustion Service, Eclipse, EXOTHERMICS, HAUCK, Kromschröder and MAXON. To learn more about our products, visit ThermalSolutions.honeywell.com or contact your Honeywell Sales Engineer.

Honeywell Process Solutions

Honeywell Thermal Solutions (HTS)

Eclipse Inc.

1665 Elmwood Rd.

Rockford, IL 61103

United States

T +1 815 877 3031

www.ThermalSolutions.honeywell.com

® U.S. Registered Trademark
© 2018 Honeywell International Inc.
32-00099-01 M.S. Rev. 09-18
Printed in United States

Honeywell
ECLIPSE®