

Eclipse ThermAir Burners

Model TA0025

Data sheet Edition 04.18

Version 3

Parameter		Specification
		Packaged Blower Size
Maximum Input, Btu/h (kW)^{1 2} <i>To maintain 15% air with the standard air orifice and standard combustion air blower</i>	Chamber Pressure "w.c. (mbar)	6" w.c. (Nominal 50 & 60 Hz)
	-1.0 (-2.5)	262,000 (77)
	0.0 (0.0)	250,000 (73)
	1.0 (2.5)	226,000 (66)
Minimum Input, Btu/h (kW) <i>For lower inputs, contact Eclipse, Inc.</i>		8,333 (2.3)
Main Gas Inlet Pressure, "w.c. (mbar) <i>Fuel pressure in gas inlet (Tap B)</i>		5.8 (14.5)
High Fire Visible Flame Length, inches (mm) <i>Measured from the outlet end of the combustor</i>	Natural Gas	30 (762)
	Propane	33 (838)
	Butane	36 (914)
Maximum Chamber Temperature, °F (°C) <i>For higher temperatures, contact Eclipse, Inc..</i>	Alloy Tube	1500 (820)
	SiC Tube	1900 (1040)
Flame Detection		Flamerod or UV Scanner
Fuels⁴ <i>For any other mixed gases, contact Eclipse, Inc.</i>		Natural Gas, Propane or Butane
Blower Motor Power, Hp		6" w.c. @ 2750 scfh, 0.25 hp
Weight, lbs (kg)⁵	With Blower	110 (50)
	Without Blower	62 (28)
Approvals		

1. Maximum inputs are given for the standard packaged combustion air blower without an air filter.
2. Blower motor service factors greater than 1.0 may be required when firing into negative chamber pressure applications. For specific application questions, contact Eclipse.
3. See Design Guide 114 for more information about typical fuel composition and properties.
4. All weights are approximate
 - All information based on laboratory testing in neutral (0.0" w.c.) chamber with standard combustion design. Different chamber conditions and/or combustor design will affect the data.
 - All inputs are based upon gross calorific values and standard conditions: 1 atmosphere, 70°F (21°C).
 - Eclipse reserves the right to change the construction and/or configuration of our products at any time without being obliged to adjust earlier supplies accordingly.

Performance Graphs

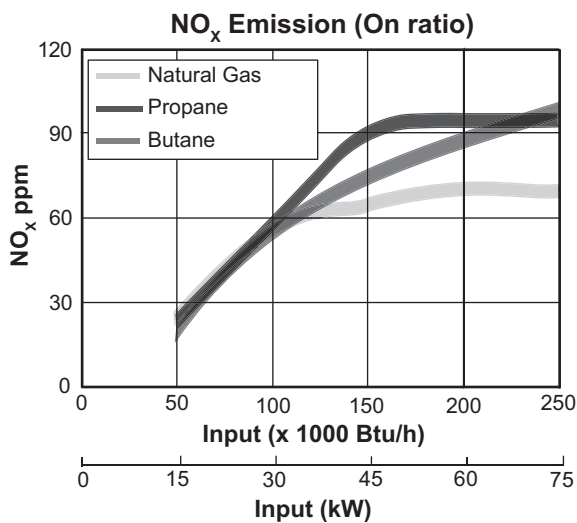
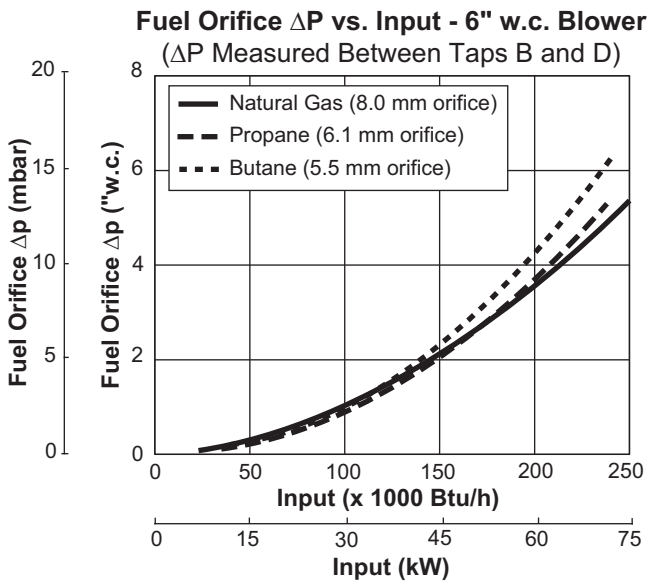
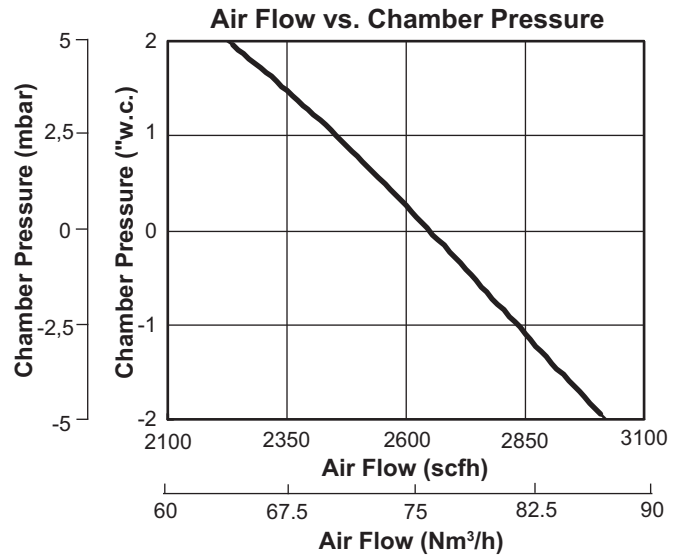
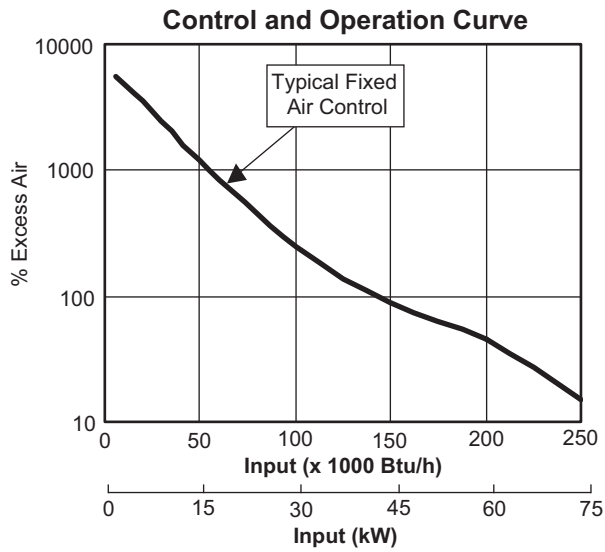

NO_x emission data is given for:

- Ambient combustion air ~70°F (21°C)
- Minimal process air velocity
- ppm volume dry at 3% O₂
- Neutral chamber pressure

Emissions are influenced by:

- Chamber conditions
- Fuel type
- Firing rate
- Ratio regulator adjustment
- Combustion air temperature

CO emission is largely influenced by chamber conditions. Contact your local Eclipse representative for an estimate of CO emission on your application.

Dimensions and Specifications

Dimensions in mm (inches)

Blower Type	C
60 Hz (6" w.c.)	301 (11.9)
50 Hz (6" w.c.)	207 (8.1)

Combustor Type	D
Straight Alloy Tube	88.9 (3.5)
Straight Silicon Tube	93.3 (3.7)

Packaged Blower

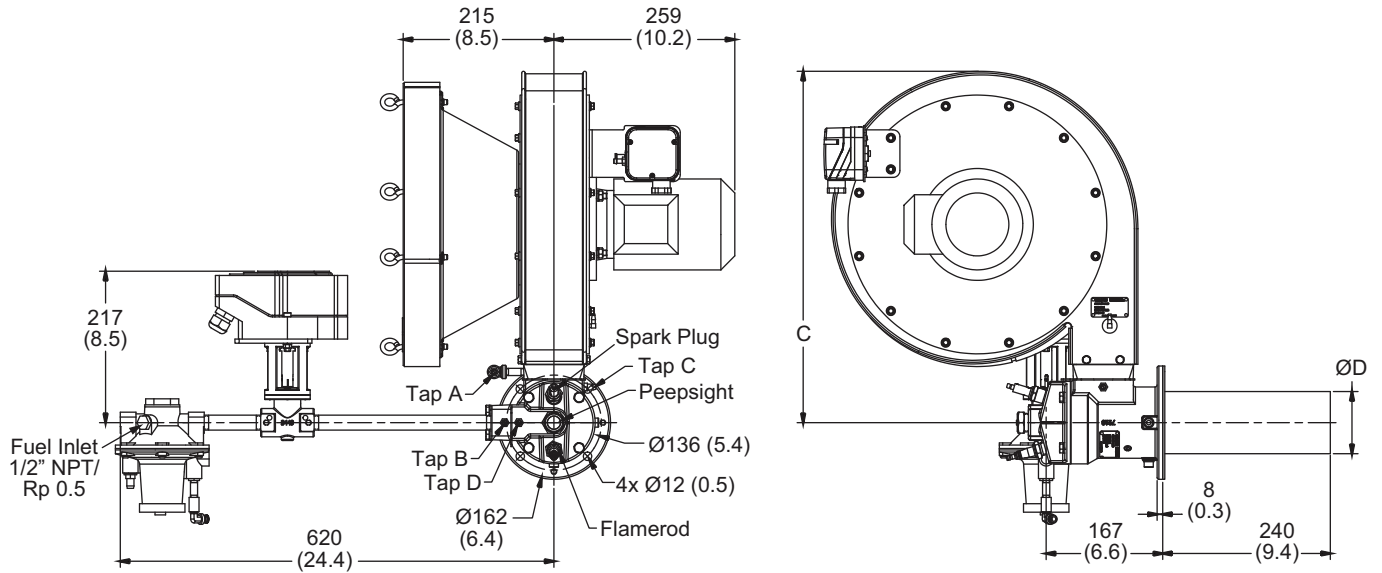

Remote Blower

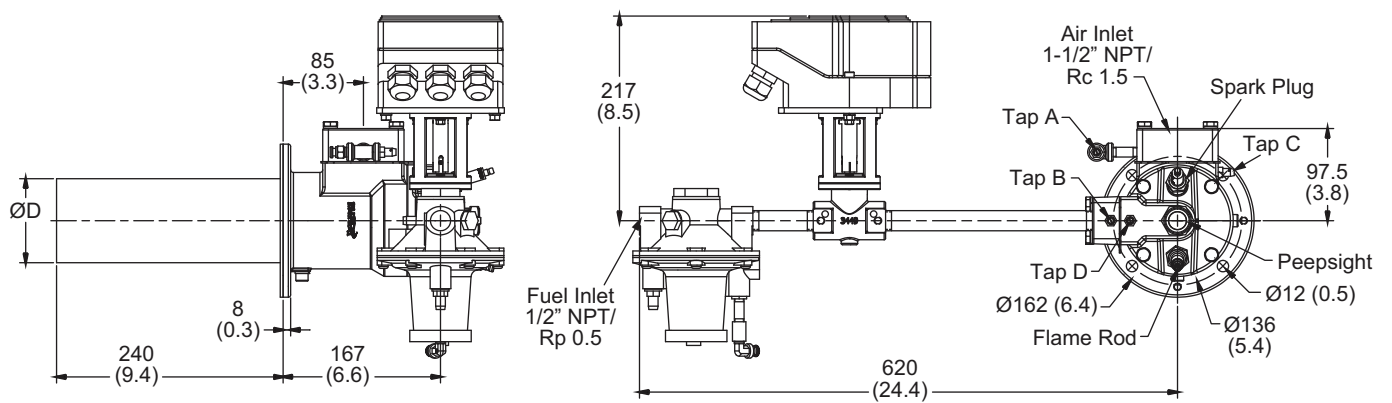

Piping

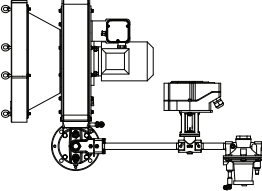
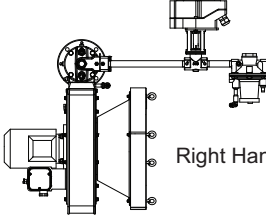
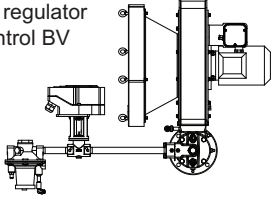
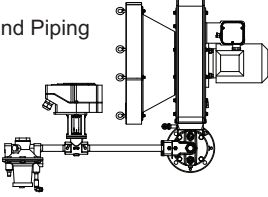
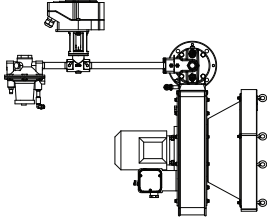
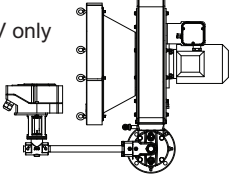
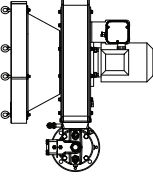
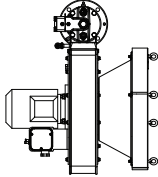
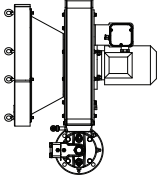
Orientation (All illustrations indicate right hand blower motor.)*		Piping Options
Upright	Inverted	
<p>Right Hand Piping</p> 	<p>Right Hand Piping</p> 	<p>With ratio regulator and control BV</p> 
<p>Left Hand Piping</p> 	<p>Left Hand Piping</p> 	<p>With control BV only</p> 
<p>No Piping</p> 	<p>No Piping</p> 	<p>Less ratio regulator and control BV</p> 

*Even though the blower motor is on the "left" side of the inverted units, it is still a "right hand" motor in relationship to the blower assembly.