

Operating instructions
Excess air burner BIC..L

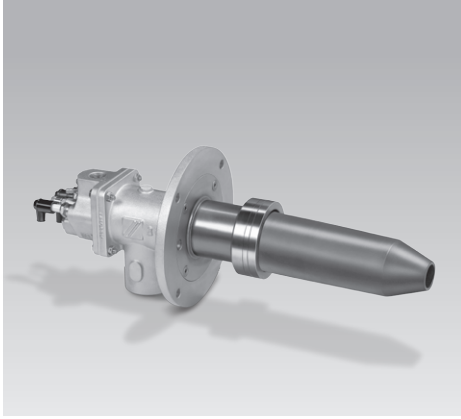

Contents

Excess air burner BIC..L 1

Contents 1

Safety..... 1

Checking the usage..... 2

Installation 3

 Installing the ceramic tube 3

 Installation on the furnace 4

 Air connection, gas connection 4

 Installing the burner insert 5

Wiring 5

Preparing commissioning 6

 Determining the flow rates 6

 Setting the air pressure for low fire and high fire. 7

 Preparing the gas pressure measurement for low fire and high fire. 8

Commissioning..... 9

 Operation with modulating gas and air volume. . 9

 Operation with modulating gas volume and constant air volume 10

 Leak test 11

 Cooling air 11

 Blocking and recording the settings..... 11

Maintenance..... 11

Assistance in the event of malfunction 13

Accessories 14

Technical data 15

Logistics 15

Declaration of Incorporation..... 16

Certification 16

Contact 16

Safety

Please read and keep in a safe place



Please read through these instructions carefully before installing or operating. Following the installation, pass the instructions on to the operator. This unit must be installed and commissioned in accordance with the regulations and standards in force. These instructions can also be found at www.docuthek.com.

Explanation of symbols

■, **1**, **2**, **3**... = Action
> = Instruction

Liability

We will not be held liable for damage resulting from non-observance of the instructions and non-compliant use.

Safety instructions

Information that is relevant for safety is indicated in the instructions as follows:

⚠ DANGER

Indicates potentially fatal situations.

⚠ WARNING

Indicates possible danger to life and limb.

! CAUTION

Indicates possible material damage.

All interventions may only be carried out by qualified gas technicians. Electrical interventions may only be carried out by qualified electricians.

Conversion, spare parts

All technical changes are prohibited. Only use OEM spare parts.

Checking the usage

Intended use

Excess air burner BIC..L for all applications requiring precise temperature control and consistent product quality. The BIC..L burner is perfectly designed for use in the tunnel kilns and intermittent systems as used in the ceramics industry. The burner can be used in conjunction with the ceramic tube set TSC in industrial furnaces or firing systems with brick lining or ceramic fibre lining. No burner block is necessary. For natural gas; other types of gas on request. This function is only guaranteed when used within the specified limits – see also page 15 (Technical data). Any other use is considered as non-compliant.

Type code

Code	Description
BIC	Burner for gas
80–140	Burner size
L	Excess air
	Gas type:
B	natural gas
Z	Special version
-0	Length of burner extension (L1) [mm]
-100	
-200 ...	
/35-	Position of burner head (L2) [mm]
/135-	
/235- ...	
-(1)–(199)	Burner head identifier
A–H	Construction stage

Part designations

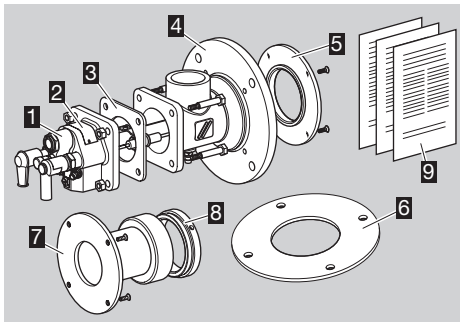

- 1 Burner insert
- 2 Type label
- 3 Gas housing gasket
- 4 Air housing
- 5 Mounting flange for TSC (for BIC(A)..-0)
- 6 Mounting gasket
- 7 Burner extension with clamping ring (for BIC(A)..-100, -200...)
- 8 Clamping ring
- 9

- 9 Enclosed documentation (flow rate curves, operating characteristic diagrams, dimension sheet, spare parts list, spare parts drawing and Declaration of Incorporation)

Type label

Construction stage, rated capacity $Q_{max.}$, gas type and diameter of gas measuring orifice – see type label.

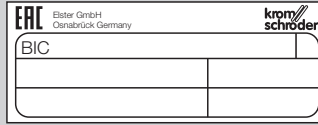

- Check letter marking and identification marks on the burner head using the information provided on the type label.

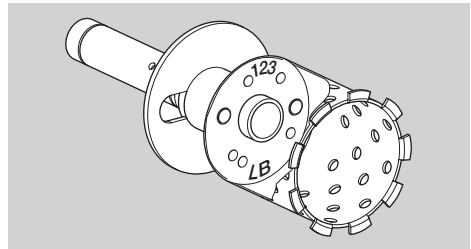

Ceramic tube

Type code

Code	Description
TSC	Ceramic tube set
80–140	Burner size
A	Cylindrical
B	Tapered
033–070	Outlet dia. D4 [mm]
-250, -300	Tube length L8 [mm]
/35-	Position of burner head L9 [mm]
Si-1500	Ceramic tube material

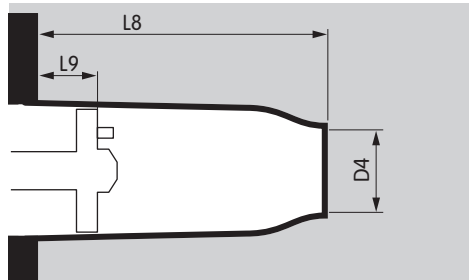

Part designations

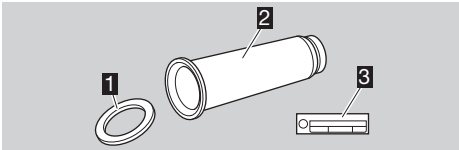

- 1 Burner tube gasket
- 2 Ceramic tube
- 3 Type label

Type label

Length and diameter – see type label.

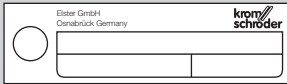

Installation

Air orifice BIC 80LB

- ▷ Depending on the ceramic tube used, it may be necessary to replace the air orifice (replacement not necessary for sizes 100 and 140).

Ceramic tube	Orifice diameter D [mm]
TSC 80B033	25.4
TSC 80B040	30.0

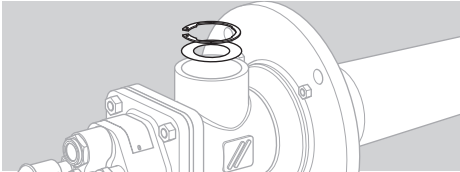

Installing the ceramic tube

⚠ WARNING

Risk of injury! Observe the projecting flame rod.

- ▷ Install the ceramic tube centrally and free of mechanical stress to avoid damage.
- ▷ Remove and dispose of transport safety device. To do so, remove the mounting flange or clamping ring.
- ▷ Remove the burner insert in order to install the ceramic tube. For this purpose, the air housing can be placed in a vertical position on a smooth working surface.

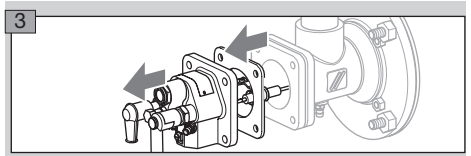
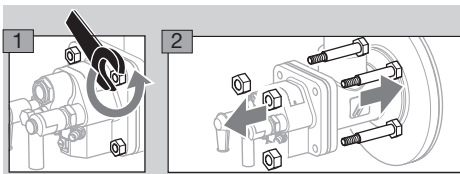

- 4 Place the burner insert in such a way that the insulators are protected against damage.

No burner extension

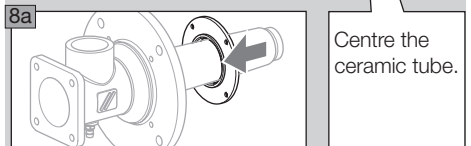
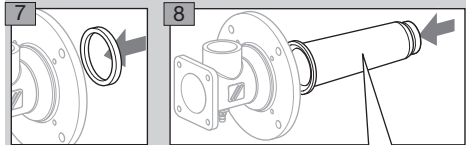
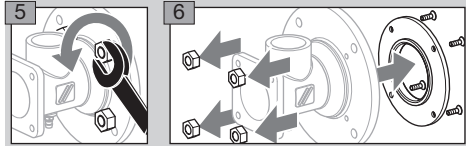

Centre the ceramic tube.

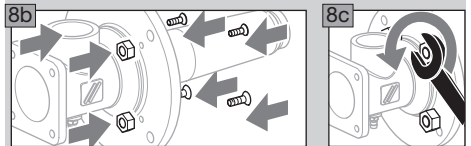

- ▷ Mounting flange and furnace flange must be flush.

With burner extension

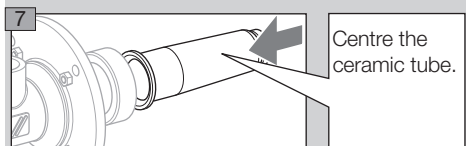
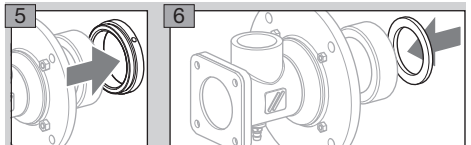

Centre the ceramic tube.

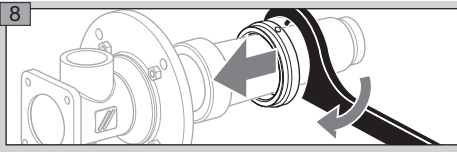

- ▷ Tighten the clamping ring as far as it will go.
- ▷ 'C' spanner, see page 14 (Accessories).

Insulating the ceramic tube

- ▷ Protect the burner extension from thermal stress.
 - ▷ We recommend solid shaped parts **A** or high temperature resistant ceramic fibrous material **B** for insulation.
 - ▷ Observe an annular void of at least 10 mm (0.4 inches).
- 9** Insulate the ceramic tube at least as far as the burner head, to a maximum of 20 mm (0.8 inches) behind the burner head.
- ▷ Burner without extension:

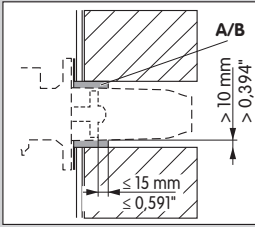

- ▷ Burner with extension:

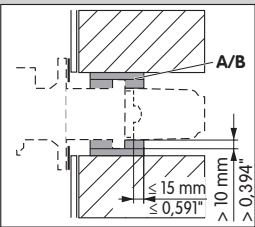

Installation on the furnace

- ▷ When installing, always ensure that when the burner is mounted, it is sealed tightly on the furnace wall.

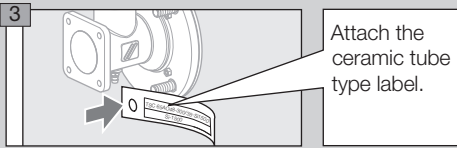
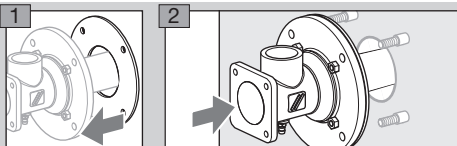

Attach the ceramic tube type label.

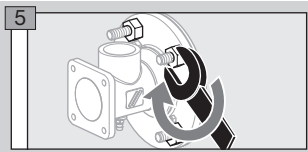
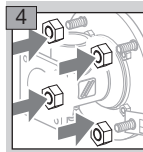

Air connection, gas connection

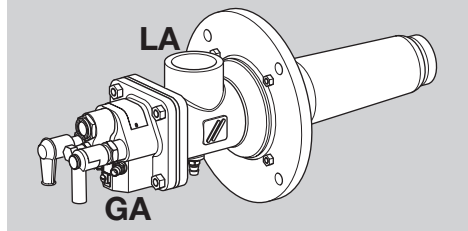

Type	Gas connection	Air connection
BIC 80	GA Rp ¾	LA* Rp 2
BIC 100	Rp 1	Rp 2
BIC 140	Rp 1½	DN 80

* Up to burner size 100: threaded connection, burner size 140: flanged connection.

- ▷ Threaded connection to ISO 7-1, flange dimensions to DIN EN 1092, PN 16.
- ▷ Install flexible tubes or bellows units to prevent mechanical stress or transmission of vibration.
- ▷ Ensure that the seals are undamaged.
- ▷ The distance between the burner gas connection and the regulator or control element for gas should be max. 0.5 m in order to ensure the maximum burner turndown is achieved. The greater the distance, the smaller the turndown.

⚠ DANGER

Risk of explosion! Ensure the connection is air-tight.

- ▷ On delivery, the threaded gas connection is situated opposite the air connection; it can be rotated in increments of 90°.

Connection to ANSI/NPT

- ▷ An adapter set is required for connection to ANSI/NPT, see page 14 (Accessories).

Type	Gas connection GA	Air connection LA
BIC 80	¾" – 14 NPT	2" – 11.5 NPT
BIC 100	1" – 11.5 NPT	2" – 11.5 NPT
BIC 140	1½" – 11.5 NPT	Dia.: 3.57"

- ▷ **BIC 80 and BIC 100:** use NPT adapter **J** for air connection **LA** and NPT thread adapter **H** for gas connection **GA**.

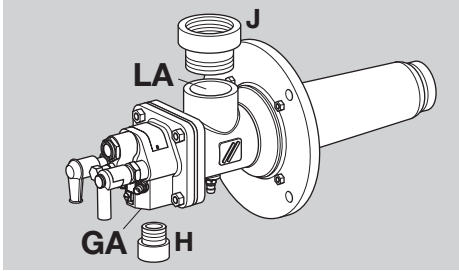

- ▷ **BIC 140:** weld flange **K** for air connection **LA** to air pipe **P** and use NPT thread adapter **H** for gas connection **GA**.

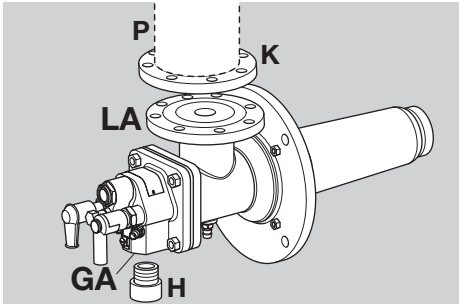

Installing the burner insert

- ▷ The burner insert can be rotated to the required position in increments of 90°.
- ▷ Insert the gas housing gasket between the burner insert and the air housing.

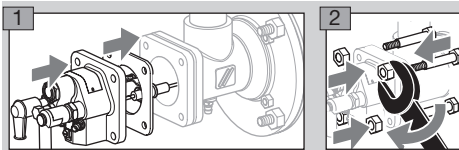

- ▷ Tighten the burner insert:
BIC 80 and BIC 100 with max. 15 Nm (11 lb ft),
BIC 140 with max. 30 Nm (22 lb ft).

Wiring

⚠ DANGER

Electric shocks can be fatal! Before working on possible live components, ensure the unit is disconnected from the power supply.

- ▷ For the ignition and ionization cables, use (un-screened) high-voltage cable:
FZLSi 1/7 up to 180°C (356°F),
Order No. 04250410, or
FZLK 1/7 up to 80°C (176°F),
Order No. 04250409.

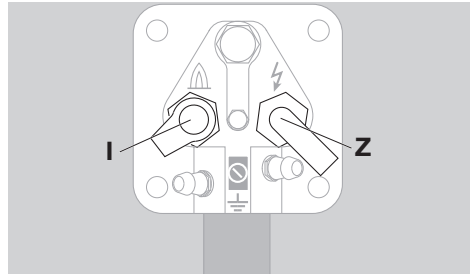

Flame rod I

- ▷ Install the ionization cable well away from mains cables and interference from electro-magnetic sources and avoid external electrical interference. Max. length of ionization cable – see automatic burner control unit operating instructions (www.docuthek.com).
- ▷ Connect the flame rod to the automatic burner control unit via the ionization cable.

Spark electrode Z

- ▷ Length of ignition cable: max. 5 m (15 ft), recommended < 1 m (40").
- ▷ For permanent ignition, max. ignition cable length 1 m (40").
- ▷ Lay the ignition cable individually and not in a metal conduit.
- ▷ Install the ignition cable separately from ionization and UV cables.
- ▷ A ≥ 7.5 kV, ≥ 12 mA ignition transformer is recommended.

Flame rod and spark electrode

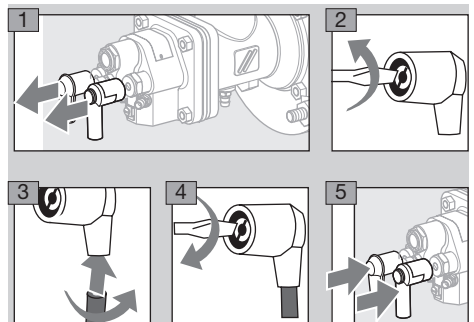

- 6 Connect the PE wire for burner ground to the burner insert.

⚠ WARNING

High-voltage risk! It is essential that a high-voltage warning label is attached to the ignition cable.

- 7 For more detailed information on how to wire the ionization and ignition cables, refer to the operating instructions and connection diagrams of the automatic burner control unit and ignition transformer.

Preparing commissioning

Safety instructions

- ▷ Agree on settings and commissioning of the burner with the system operator or manufacturer.
- ▷ Check the entire system, upstream devices and electrical connections.
- ▷ Note the operating instructions for individual controls.

⚠ DANGER

The burner must only be commissioned by authorized trained personnel.

Risk of explosion! Please observe the appropriate precautions when igniting the burner.

Risk of poisoning! Open the gas and air supply so that the burner is always operated with excess air – otherwise CO will form in the furnace chamber. CO is odourless and poisonous! Conduct a flue gas analysis.

- ▷ Pre-purge the furnace chamber with air (5 x furnace chamber volume) before every ignition attempt.
- ▷ If the burner does not ignite although the automatic burner control unit has been switched on and off several times, the entire system is to be checked.
- ▷ After ignition, monitor the flame and the gas and air pressure measured on the burner. Measure the ionization current. Switch-off threshold – see automatic burner control unit operating instructions (www.docuthek.com).

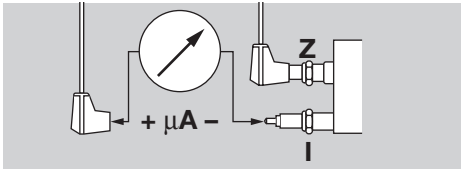

- ▷ Ignite the burner according to the specifications in the operating characteristic diagram.
- ▷ The burner must only be ignited at low-fire rate (between 10 and 40% of the rated capacity $Q_{max.}$) – see type label.

⚠ DANGER

Risk of explosion! Fill the gas line to the burner carefully and correctly with gas and vent it safely into the open air – do not discharge the test volume into the furnace chamber.

Determining the flow rates

$$Q_{Gas} = P_B / H_u$$

$$Q_{Air} = Q_{Gas} \cdot \lambda \cdot L_{min}$$

- ▷ Q_{Gas} : Gas flow rate in m^3/h (ft^3/h)
- ▷ P_B : Burner capacity in kW (BTU/h)
- ▷ H_u : Gas calorific value in kWh/m^3 (BTU/ ft^3)
- ▷ Q_{Air} : Air flow rate in m^3/h (ft^3/h)
- ▷ λ : Lambda, air index
- ▷ L_{min} : Minimum air requirement in m^3/m^3 (ft^3/ft^3)
- Use the lower calorific value H_u .
- ▷ Information on the gas quality supplied can be obtained from the competent gas supply company.

Common gas qualities

Gas type	H_u kWh/ m^3 (BTU/ ft^3)	L_{min} m^3/m^3 (ft^3/ft^3)
Natural gas H	11 (1063)	10.6 (374)
Natural gas L	8.9 (860)	8.6 (304)

- ▷ For safety reasons, a minimum air excess of 10% ($\lambda = 1.1$) should be set.

Notes on the flow rate curve

- ▷ If the gas density in the operating state differs from that reflected in the flow rate curve, convert the pressures according to the local operating state.

$$P_B = P_M \cdot \frac{\delta_B}{\delta_M}$$

- ▷ δ_M : Gas density reflected in the flow rate curve [kg/m^3 (lb/ ft^3)]
- ▷ δ_B : Gas density in operating state [kg/m^3 (lb/ ft^3)]
- ▷ P_M : Gas pressure reflected in the flow rate curve
- ▷ P_B : Gas pressure in operating state

- Read off the differential pressure Δp_{Gas} and air pressure p_{Air} from the flow rate curve for cold air on the basis of the calculated flow rates.

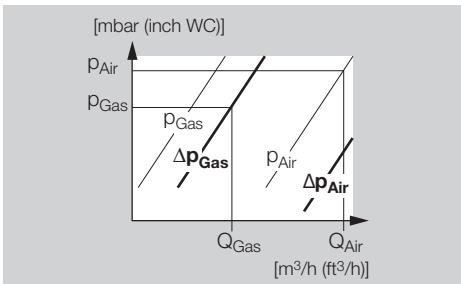

- ▷ Note possible capacity changes (air) due to pressure loss in the furnace chamber/burner tile. Add positive pressures or subtract negative pressures.
- ▷ The differential pressures Δp_{Gas} and Δp_{Air} measured on the integrated measuring orifices are independent of the furnace chamber pressure.
- ▷ As not all the effects caused by the equipment are known, setting the burner using the pressure values is only approximate. It is possible to set the burner precisely by measuring the flow rates or flue gas.

! CAUTION

If reducing fittings or manual valves with internal thread are installed, Δp_{Gas} on the integrated gas measuring orifice is reduced.

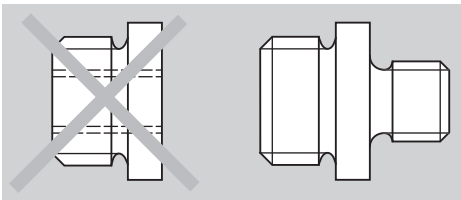

- ▷ Reducing fitting with internal and external thread: deviation from the flow rate curves may occur when the cross-section of the reducing fitting differs from that of the threaded gas connection **GA** or when a manual valve is screwed directly into the burner.
- ▷ Reducing nipple with external thread at both ends: no deviation from the flow rate curves occurs.
- ▷ Ensure an undisturbed flow to the measuring orifice!

Restrictors

- ▷ The air volume required for the low-fire rate at a given air pressure is determined by the ignition position of a butterfly valve, a bypass hole in the air valve or an external bypass with restrictor.
- ▷ Burners as from construction stage E (see type label) are equipped with gas flow adjustment to replace the restrictor in the gas pipe.

Hot air compensation

- ▷ The combustion air pressure p_{Air} must be increased in hot air operating mode ($\lambda = \text{constant}$).

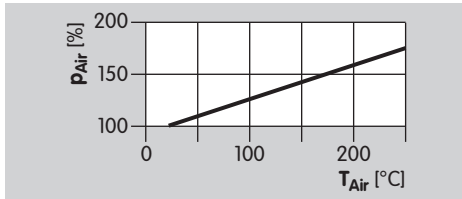

- ▷ At a constant gas pressure on the burner, the gas volume decreases (reduction < 5%) as the combustion air temperature increases. Accordingly, the air pressure must be increased less.
- ▷ The total burner capacity P_{B} rises as the air temperature T_{air} increases.

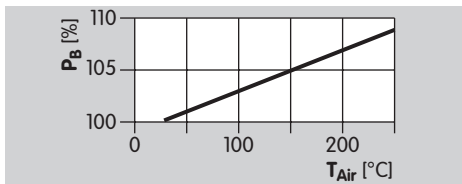

Setting the air pressure for low fire and high fire

- 1 Shut off the gas and air supply.
 - ▷ Air connection **LA** on BIC 80L, BIC 100L via threaded connection with 2 pressure taps and measuring orifice installed in-between.
 - ▷ Air connection **LA** on BIC 140L via flanged connection with a pressure tap and measuring orifice. A second pressure tap must be installed in the air supply line. The distance between the pressure taps must be max. 65 mm.

BIC 80L, BIC 100L

2  Loosen the screw 2 turns.

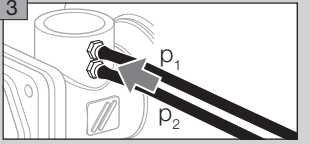
3  Fully open the air supply.

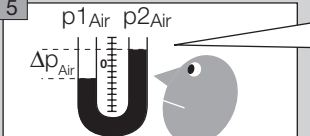
5  Δp_{Air} = differential air pressure.

BIC 140L

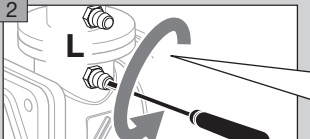
2  Loosen the screw 2 turns.

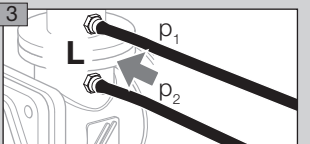
3  Fully open the air supply.

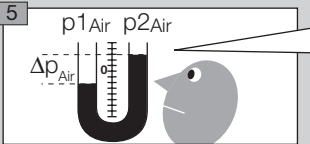
5  Δp_{Air} = differential air pressure.

Low-fire rate

- 6** Reduce the air supply on the air control valve and set the desired low-fire rate, e.g. using a limit switch or mechanical stop.
- ▷ On air control valves with bypass, the bypass orifice should be determined on the basis of the required flow rate and the existing supply pressure if required.

High-fire rate

- ▷ Set the required air pressure Δp_{Air} on the air restrictor upstream of the burner or on the air control valve.
- ▷ When using air restricting orifices: check the air pressure Δp_{Air} .

Preparing the gas pressure measurement for low fire and high fire

- 1** Connect all measuring devices for subsequent fine adjustment of the burner.
- ▷ Leave the gas supply closed.
 - ▷ Gas measuring nipple **G**, outside dia. = 9 mm (0.35").
- 2** Read off the differential pressure for the required gas flow rate from the enclosed flow rate curve for cold air.

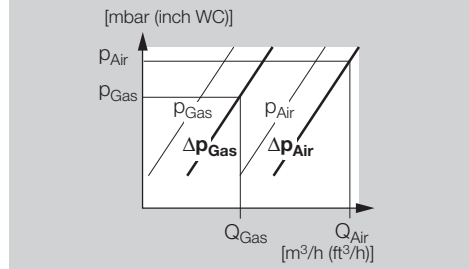

- 3** **p₁**: gas pressure upstream of the measuring orifice, **p₂**: gas pressure downstream of the measuring orifice.

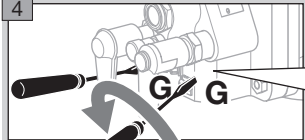
4  Loosen the screw 2 turns.

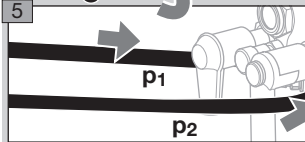
5 

Commissioning

⚠ WARNING

Ensure adequate ventilation of the furnace chamber before each burner start!

- ▷ The burner body will become hot during operation with preheated combustion air. Provide protection against accidental contact as required.

Operation with modulating gas and air volume

- 1** All valves of the installation must be checked for tightness before ignition.

Setting the low-fire rate

- 2** Set the valves to ignition position.
 - 3** Limit the maximum gas volume.
- ▷ Should an adjustable gas restrictor be installed upstream of the burner, open the restrictor by approx. a quarter.
 - ▷ Alternatively, close the integrated flow rate restrictor approx. 10 turns:

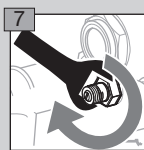
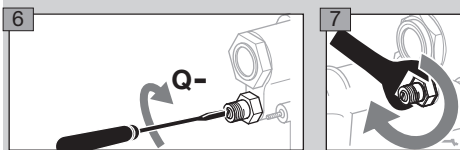
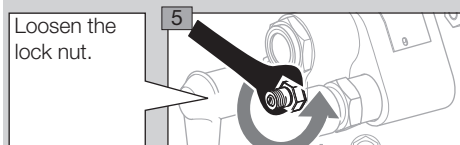
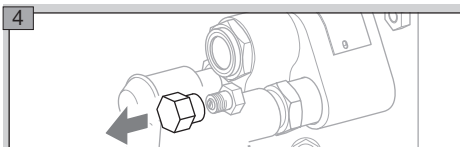

- 8** Open the gas supply.
- 9** Ignite the burner.
 - ▷ The safety time of the automatic burner control unit starts to elapse.
 - ▷ If no flame is detected – see page 13 (Assistance in the event of malfunction).
 - ▷ The burner ignites and proceeds to normal operation.
- 10** Check flame stability and ionization current at low-fire rate. Switch-off threshold – see automatic burner control unit operating instructions (www.docuthek.com).

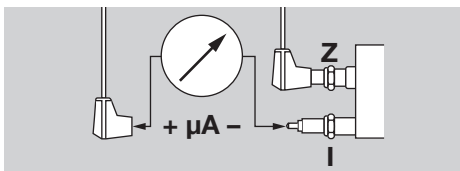

- 11** Monitor flame formation.
- 12** Adjust the low-fire rate settings if required.
 - ▷ If no flame is detected – see page 13 (Assistance in the event of malfunction).

Setting the high-fire rate

- 13** Set the air and gas circuit of the burner to high fire while continuously monitoring the flame.
 - ▷ Avoid CO formation – always operate the burner with excess air when starting up.
- 14** Set the differential pressure Δp_{Gas} using the integrated flow rate restrictor:

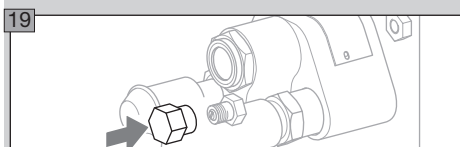
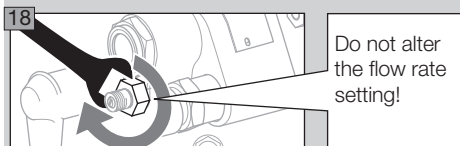
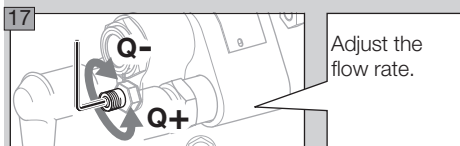
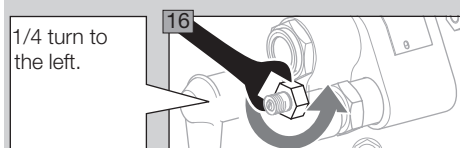
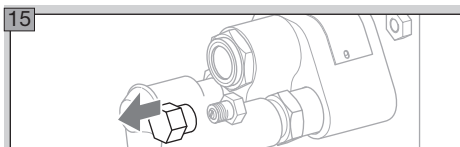
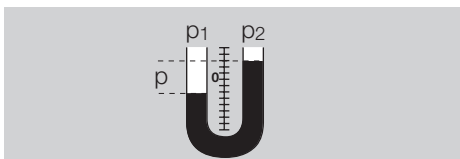

- ▷ On delivery, the flow rate restrictor is 100% open.

Re-adjusting the air flow rate

- 20** Check the differential pressure Δp_{Air} on the burner and adjust using the air restrictor if required.

Operation with modulating gas volume and constant air volume

- 1** All valves of the installation must be checked for tightness before ignition.

Setting the high-fire rate

- 2** Pre-set the air volume required for the high-fire rate.
- 3** Limit the maximum gas volume.
- ▷ Should an adjustable gas restrictor be installed upstream of the burner, open the restrictor by approx. a quarter.
 - ▷ Alternatively, close the integrated flow rate restrictor approx. 10 turns:

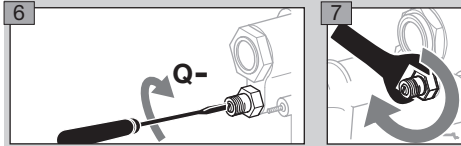
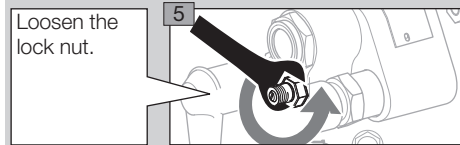
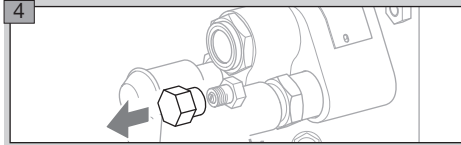

- 8** Fully open the control valve for modulating the gas volume.

- 9** Open the gas supply.

- 10** Ignite the burner.

- ▷ The safety time of the automatic burner control unit starts to elapse.
- ▷ If no flame is detected – see page 13 (Assistance in the event of malfunction).
- ▷ The burner ignites and proceeds to normal operation.

- 11** Set the differential pressure Δp_{Gas} using the integrated flow rate restrictor:

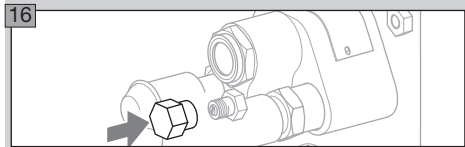
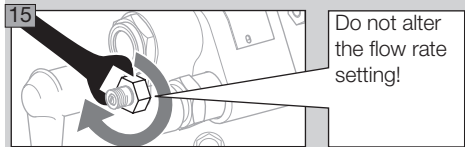
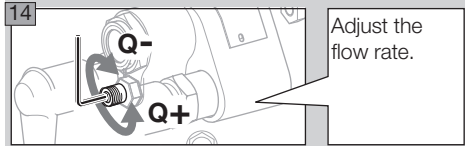
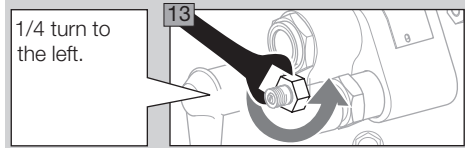
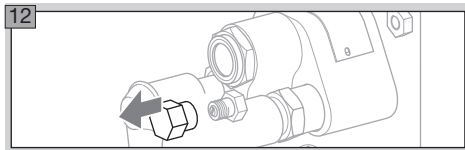
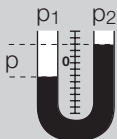

- 17** Check the differential pressures Δp_{Air} and Δp_{Gas} on the burner and adjust if required.

- ▷ If no flame is detected – see page 13 (Assistance in the event of malfunction).

⚠ DANGER

Risk of explosion and poisoning in case of burner adjustment with an air deficiency! Adjust the gas and air supply so that the burner is always operated with excess air – otherwise CO will form in the furnace chamber. CO is odourless and poisonous! Conduct a flue gas analysis.

Setting the low-fire rate

- 18** To set the low-fire rate, the gas volume is reduced while keeping the air volume constant (excess air).

- ▷ Turndown – see operating characteristic diagram (www.docuthek.com).

- 19** Check flame stability and ionization current at low-fire rate. Switch-off threshold – see automatic burner control unit operating instructions (www.docuthek.com).

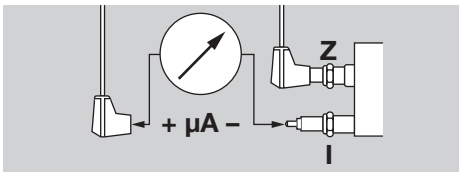

20 Monitor flame formation.

21 Adjust the low-fire rate settings if required.

Leak test

⚠ DANGER

To ensure that there is no danger resulting from a leak, check the gas connections on the burner for leaks immediately after the burner has been put into operation.

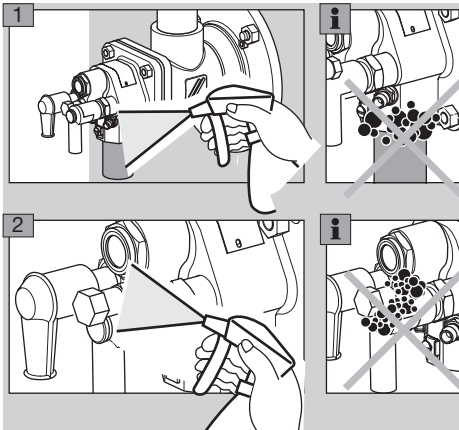

Cooling air

▷ While the burner is switched off and depending on the furnace temperature, there must be a certain air flow (approx. 2 to 6% of the rated capacity) in order to ensure safe ignition and monitoring of the burner, and for cooling the burner components.

Blocking and recording the settings

- 1** Produce a measurement report.
- 2** Set the burner to low fire and check the settings.
- 3** Set the burner to low and high fire several times while monitoring the pressure settings, flue gas values and flame patterns.
- 4** Remove the measuring devices and close off the pressure taps – tighten the grub screws.
- 5** Block and seal the adjusting elements.
- 6** Induce a flame failure, e.g. by pulling the terminal boot off the flame rod. The flame detector must close the gas safety valve and signal a fault.
- 7** Switch the system on and off several times while monitoring the automatic burner control unit.
- 8** Produce an acceptance report.

⚠ DANGER

An incorrect change of the burner settings may change the gas/air ratio and lead to unsafe operating conditions: risk of explosion in case of CO being formed in the furnace chamber! CO is odourless and poisonous!

Maintenance

We recommend that a function check is carried out every six months.

⚠ WARNING

Risk of burning! Outflowing flue gases and burner components are hot.

- 1** Check the ionization and ignition cables.
 - 2** Measure the ionization current.
- ▷ The ionization current must be at least 5 µA and must not vary.

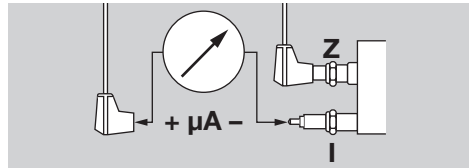

- 3** Disconnect the system from the electrical power supply.
- 4** Shut off the gas and air supply – do not change the restrictor settings.

Checking the spark electrode and flame rod

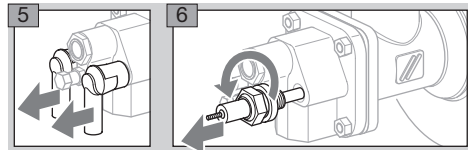

- ▷ Ensure that the electrode length does not change.
- 7** Remove dirt from electrodes or insulators.
 - 8a** If the star **4** or insulator **3** is damaged, replace the electrode.

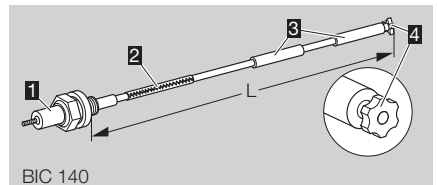

- 8b** If the electrode **4** or insulator **3** is damaged, replace the electrode.

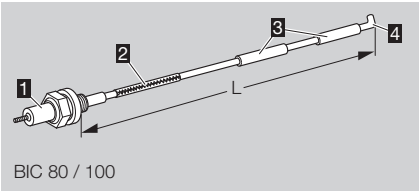

- 8c** If the electrode **4** or insulator **3** is damaged, replace the electrode.

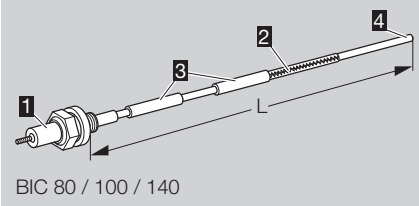

- ▷ Before changing the electrode, measure the total length **L**.

- 9** Connect the new electrode with the spark plug **1** using the dowel pin **2**.

- 10** Adjust spark plug and electrode to the measured total length **L**.

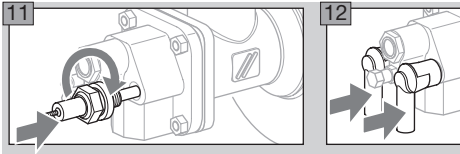

- ▷ Turning the spark plug makes it easier to feed the electrode into the burner insert.

Checking the burner

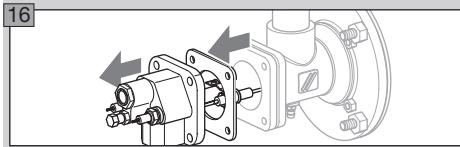
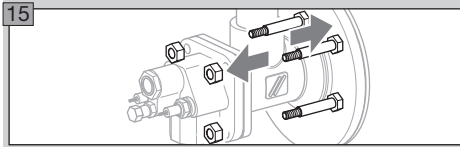
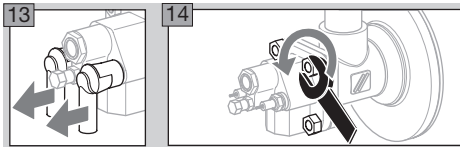

- ▷ If the burner insert is dismantled, the gas housing gasket will have to be renewed.

- 17** Place the burner insert in a safe place.

- ▷ Depending on the amount of dirt or wear: replace the spark electrode/flame rod and dowel pin during servicing – see page 11 (Checking the spark electrode and flame rod).

- 18** Check burner head for dirt and thermal cracks.

⚠ WARNING

Risk of injury! Burner heads have sharp edges.

- ▷ When replacing any burner components: apply ceramic paste to the screw connections in order to avoid cold-setting – see page 14 (Accessories).

- 19** Check the electrode positions.

- ▷ The insulator must be flush with the front edge of the burner air disc.

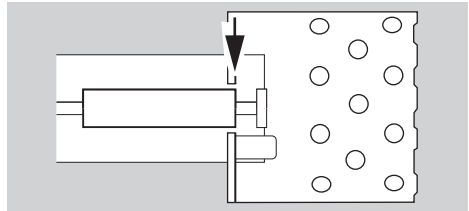

- ▷ Distance of spark electrode from ground pin or gas nozzle: $2 \pm 0.5 \text{ mm}$ (0.08 ± 0.02 ”).

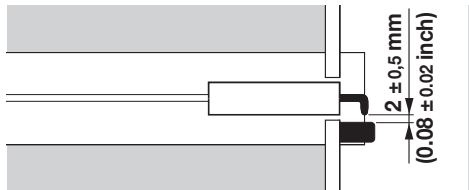
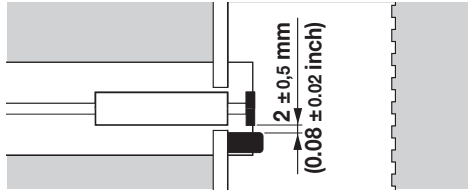

- 20** When the furnace chamber has cooled down, check the ceramic tube through the furnace flange.

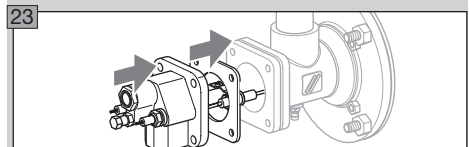
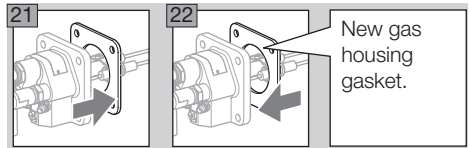

- ▷ Tighten the burner insert: BIC 80 and 100 with max. 15 Nm (11 lb ft), BIC 140 with max. 30 Nm (22 lb ft).

24 Connect the system to the electrical power supply.

25 Open the gas and air supply.

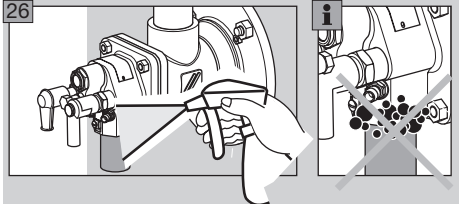

27 Set the burner to low fire and compare the pressure settings to those stated in the acceptance report.

28 Set the burner to low and high fire several times while monitoring the pressure settings, flue gas values and flame patterns.

⚠ DANGER

Risk of explosion and poisoning in case of burner adjustment with an air deficiency! Adjust the gas and air supply so that the burner is always operated with excess air – otherwise CO will form in the furnace chamber. CO is odourless and poisonous! Conduct a flue gas analysis.

29 Produce a maintenance report.

Assistance in the event of malfunction

⚠ DANGER

Electric shocks can be fatal! Before working on possible live components, ensure the unit is disconnected from the power supply.

Risk of injury! Burner heads have sharp edges. Fault-clearance must only be undertaken by authorized trained personnel.

- ▷ If no fault is detected when checking the burner, proceed to the automatic burner control unit and check for faults in accordance with the relevant operating instructions.

? Faults

! Cause

• Remedy

? Burner does not function?

! Valves do not open.

- Check the voltage supply and wiring.

! Tightness control signals a fault.

- Check the valves for tightness.
- Note the tightness control operating instructions.

! Control valves do not move to low-fire rate position.

- Check the impulse lines.

! Gas inlet pressure is too low.

- Check the filter for dirt.

! Delta of the gas and air pressures on the burner is too low.

- Check the restrictors.
- Check the fan.
- In the case of operation with bypass (e.g. when using an air/gas ratio control): check the bypass nozzle and adjust if required.
- In the case of operation without bypass (e.g. when using an air/gas ratio control without bypass): increase the low-fire rate setting.
- Check the basic setting or bypass of the air control valve.

! Automatic burner control unit signals a fault.

- Check the ionization cables and ionization current.
- Check whether the burner is adequately grounded.
- Note the automatic burner control unit operating instructions.

? Burner performs a fault lock-out after burning faultlessly in normal operation?

- ! Incorrect gas and air flow rate settings.
 - Check delta of the gas and air pressures.

- ! No ignition spark is created.
 - Check the ignition cable.
 - Check the voltage supply and wiring.
 - Check whether the burner is adequately grounded.
 - Check the electrodes – see page 11 (Checking the spark electrode and flame rod).

- ! Automatic burner control unit signals a fault.
 - Check the ionization cable.
 - Measure the ionization current by connecting a micro-ammeter into the ionization cable – min. 5 μA ionization current – stable signal.

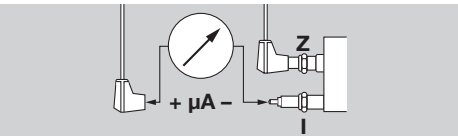

- ! Burner head dirty.
 - Clean gas and air bore holes.
 - Remove deposits on the burner head.

⚠ WARNING

Risk of injury! Burner heads have sharp edges.

- ! Excessive pressure fluctuations in the furnace chamber.
 - Ask Honeywell Kromschroder for control concepts.

Accessories

'C' spanner

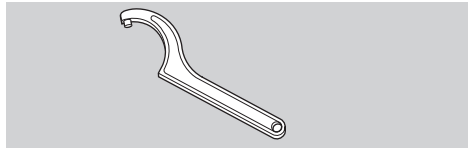

Burner size	Order No.
BIC 80, BIC 100	03352003
BIC 140	03352005

Ceramic paste

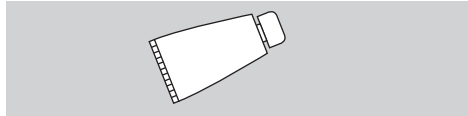

Apply ceramic paste to the screw connections after replacing any burner components in order to avoid cold-setting.
Order No.: 05012009.

Adapter set



For connecting BIC to NPT/ANSI connections.

Burner	Adapter set	Order No.
BIC 80	BR 80 NPT	74922632
BIC 100	BR 100 NPT	74922633
BIC 140	BR 140 NPT	74922635

Technical data

Burner

Gas supply pressure: approx. 30 to 70 mbar,
air supply pressure: approx. 45 to 75 mbar,
each depending on gas type and air temperature
(gas and air pressures – see operating characteris-
tic diagrams at www.docuthek.com).

Burner length increments: 100 mm.

Gas types: natural gas.

Control type:

continuous: constant air volume,

continuous: constant λ value.

Most of the burner components are made of corro-
sion-resistant stainless steel.

Housing: cast steel.

Control: with flame rod.

Ignition: direct spark ignition.

Maximum furnace temperature:

up to 1250°C (higher temperatures on request).

Maximum air temperature:

up to 250°C.

Ambient conditions: -20°C to +180°C

(68°F to 356°F) (outside the thermoprocessing
system).

No condensation permitted, painted surfaces may
corrode.

Burner	Weight* [kg]
BIC 80	10.7
BIC 100	11.7
BIC 140	26.7

* Shortest overall length without ceramic tube.

Ceramic tube

Material: SI-1500.

Logistics

Transport

Protect the unit from external forces (blows, shocks,
vibration). On receipt of the product, check that the
delivery is complete, see page 2 (Part designa-
tions). Report any transport damage immediately.

Storage

Store the product in a dry and clean place.

Storage temperature: see page 15 (Technical data).

Storage time: 6 months in the original packaging
before using for the first time. If stored for longer
than this, the overall service life will be reduced by
the corresponding amount of extra storage time.

Packaging

The packaging material is to be disposed of in ac-
cordance with local regulations.

Disposal

Components are to be disposed of separately in
accordance with local regulations.

Declaration of Incorporation

according to 2006/42/EC, Annex II, No. 1B
The product "Burner for gas BIC..L" is a partly completed machine pursuant to Article 2g and is designed exclusively for installation in or assembly with another machine or other equipment.

The following essential health and safety requirements in accordance with Annex I of this Directive are applicable and have been fulfilled:

Annex I, Articles 1.1.3, 1.1.5, 1.3.2, 1.3.4, 1.5.2, 1.7.4
The relevant technical documentation has been compiled in accordance with part B of Annex VII and will be sent to the relevant national authorities on request as a digital file.

The following (harmonized) standards have been applied:

- EN 746-2:2010 – Industrial thermoprocessing equipment; Safety requirements for combustion and fuel handling systems
- EN 12100:2010 – Safety of machinery – General principles for design – Risk assessment and risk reduction (ISO 12100:2010)

The partly completed machine may only be commissioned once it has been established that the machine into which the product mentioned above is to be incorporated complies with the provisions of the Machinery Directive 2006/42/EC.
Elster GmbH

Honeywell

krom
schroder

Einbauerklärung

nach 2006/42/EG, Anhang II, Nr. 1B

Folgende Produkt: / The following product:

Bezeichnung: / Name
Typenummer: / Type

Declaration of Incorporation

/ according to 2006/42/EC, Annex II No. 1B

burner for gas
 BIC, BICL, BIC, BICL, BIC
 BIC, BICL, BIC, BICL

Alle wesentlichen Merkmale sind listed by this declaration and they will be incorporated into the machine in accordance with the provisions of Annex I of this Directive and applicable and have been fulfilled.

Folgende grundlegende Sicherheits- und Gesundheitsanforderungen gemäß Anhang I dieser Richtlinie können als Anhang II dieser Erklärung angegeben:

Anhang I Artikel / Annex I Article
1.1.3, 1.1.5, 1.3.2, 1.3.4, 1.5.2, 1.7.4

Die relevanten technischen Unterlagen gemäß Anhang II dieser Richtlinie werden auf Verlangen der zuständigen nationalen Behörden auf Anfrage in digitaler Form übermittelt.

Folgende harmonisierte Normen wurden angewandt: / The following harmonized standards have been applied:

EN 746-2:2010 – Industrielle Thermoprocessinganlagen; Sicherheitsanforderungen an Feueranlagen und Brenneinrichtungen
– Industrial thermoprocessing equipment; Safety requirements for combustion and fuel handling systems
EN 12100:2010 – Sicherheit von Maschinen – Allgemeine Gestaltungsgrundsätze – Risikobewertung
und Risikoreduzierung (ISO 12100:2010)
– Safety of machinery – General principles for design – Risk assessment
and risk reduction (ISO 12100:2010)

Die vorläufige Maschine darf nicht ohne in Betrieb genommen werden, wenn festgelegt wurde, dass die Maschine in der dies diese wesentlichen Merkmale eingetragenen werden soll. Die Bestimmungen der Richtlinie für Maschinen (2006/42/EG) anzuwenden.

The partly completed machine may only be commissioned once it has been established that the machine into which the product mentioned above is to be incorporated complies with the provisions of the Machinery Directive 2006/42/EC.

Lotte Büren
11 49504
Daten: / Data

S. Ründe
Sandra Ründe
Kundenbetreuung / Design

Seite 1 von 1
Drucken Dr. Dr.
Drucken Dr. Dr.
Drucken Dr. Dr.
Drucken Dr. Dr.
Drucken Dr. Dr.
Drucken Dr. Dr.
Drucken Dr. Dr.
Drucken Dr. Dr.
Drucken Dr. Dr.
Drucken Dr. Dr.

Sandra Ründe ist autorisiert, die wesentlichen Merkmale gemäß Anhang II dieser Richtlinie anzugeben.
Sandra Ründe is authorized to compile the relevant technical documentation according to Annex II B.

Certification

Eurasian Customs Union

EAC

The product BIC..L meets the technical specifications of the Eurasian Customs Union.

Contact

If you have any technical questions, please contact your local branch office/agent. The addresses are available on the Internet or from Elster GmbH.

We reserve the right to make technical modifications in the interests of progress.

GB-16

Honeywell

krom
schroder

Elster GmbH
Strotheweg 1, D-49504 Lotte (Büren)

Tel. +49 541 1214-0

Fax +49 541 1214-370

hts.lotte@honeywell.com, www.kromschroeder.com