

Eclipse AirHeat Burners

*Model AH
Operating Instructions*

Version 2

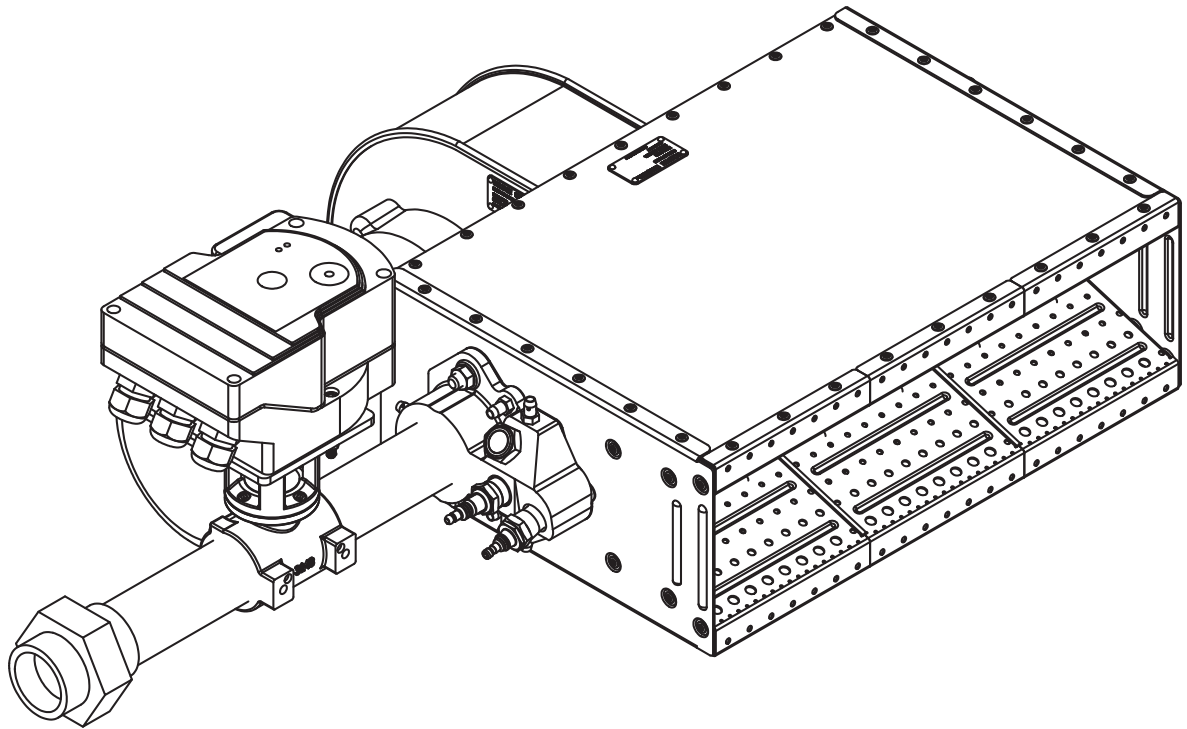

Copyright

Copyright 2017 by Eclipse, Inc. All rights reserved worldwide. This publication is protected by federal regulation and shall not be copied, distributed, transmitted, transcribed or translated into any human or computer language, in any form or by any means, to any third parties, without the express written consent of Eclipse, Inc.

Disclaimer Notice

In accordance with the manufacture's policy of continual product improvement, the product presented in this brochure is subject to change without notice or obligation.

The material in this manual is believed adequate for the intended use of the product. If the product is used for purposes other than those specified herein, confirmation of validity and suitability must be obtained. Eclipse warrants that the product itself does not infringe upon any United States patents. No further warranty is expressed or implied.

Liability & Warranty

We have made every effort to make this manual as accurate and complete as possible. Should you find errors or omissions, please bring them to our attention so that we may correct them. In this way we hope to improve our product documentation for the benefit of our customers. Please send your corrections and comments to our Marketing Communications Manager.

It must be understood that Eclipse's liability for its product, whether due to breach of warranty, negligence, strict liability, or otherwise is limited to the furnishing of replacement parts and Eclipse will not be liable for any other injury, loss, damage or expenses, whether direct or

consequential, including but not limited to loss of use, income, or damage to material arising in connection with the sale, installation, use of, inability to use, or the repair or replacement of Eclipse's products.

Any operation expressly prohibited in this manual, any adjustment, or assembly procedures not recommended or authorized in these instructions shall void the warranty.

Document Conventions

There are several special symbols in this document. You must know their meaning and importance.

The explanation of these symbols follows below. Please read it thoroughly.

How To Get Help

If you need help, contact your local Eclipse representative. You can also contact Eclipse at:

1665 Elmwood Rd.
Rockford, Illinois 61103 U.S.A.
Phone: 815-877-3031
Fax: 815-877-3336
<http://www.eclipsenet.com>

Please be sure to know your equipment's information found on the product label when contacting the factory so we may better serve you.

 ECLIPSE <small>Innovative Thermal Solutions</small>	www.eclipsenet.com
Product Name	
Item #	
S/N	
DD MMM YYYY	



This is the safety alert symbol. It is used to alert you to potential personal injunt hazards. Obey all safety messages that follow this symbol to avoid possible injury or death.



Indicates a hazardous situation which, if not avoided, will result in death or serious injury.



Indicates a hazardous situation which, if not avoided, could result in death or serious injury.



Indicates a hazardous situation which, if not avoided, could result in minor or moderate injury.

NOTICE

Is used to address practices not related to personal injury.

NOTE

Indicates an important part of text. Read thoroughly.

Table of Contents

Introduction	4
Product Description	4
Audience	4
Purpose	4
AirHeat Documents	4
Related Documents	4
Safety	5
Safety Warnings	5
Capabilities	5
Operator Training	5
Replacement Parts	5
Installation	6
Introduction	6
Handling & Storage	6
Approvals of Components	6
Checklist Before Installation	7
Burner Mounting	7
Installing the Flame Sensor	8
Checklist After Installation	8
Prepare for Adjustment	9
Adjustment, Start & Stop	10
Burner Adjustment	10
Step 1: Reset the System	10
Step 2: Set the Air Flow	10
Step 3: Ignite the Burner	10
Step 4: Set High Fire Gas	11
Step 5: Set Low Fire Gas	11
Step 6: Verify Settings	11
Step 6: Stop Procedure	11
Maintenance & Troubleshooting	12
Monthly Checklist	12
Yearly Checklist	12
Recommended Spare Parts	12
Troubleshooting	13
Appendix	i
System Schematics	ii

Introduction

1

Product Description

Eclipse AirHeat Burners are line type burners ideal for generating large volumes of clean, hot air. Applications include ovens, dryers, fume incinerators, and similar industrial equipment. Burners are constructed of aluminum burner bodies and diverging stainless steel air wings. The burner bodies supply fuel to the center of the air wings. The air and fuel mixture inside the burner is controlled to optimize emissions and efficiency.

AirHeat Burners are assembled from straight and tee sections allowing for customized inputs. An integral combustion air blower can be ordered mounted on the back of the burner's steel or stainless steel housing case. By supplying the correct air volume and pressure to the burner, the blower allows stable operation over a wide range of duct velocities without installing a profile plate around the burner.

Brackets are available for slot firing or duct mounting and flanges are available for continuous flange mounting. Right hand or left hand gas piping can be supplied with BSP or NPT connections. A reduced port fuel control valve can be supplied with a variety of control motor and linkage options. Ignition can be by direct spark or by spark ignited pilot. Flame rod flame supervision can be from either or both ends. Several air flow switches are also available factory mounted on the burner.

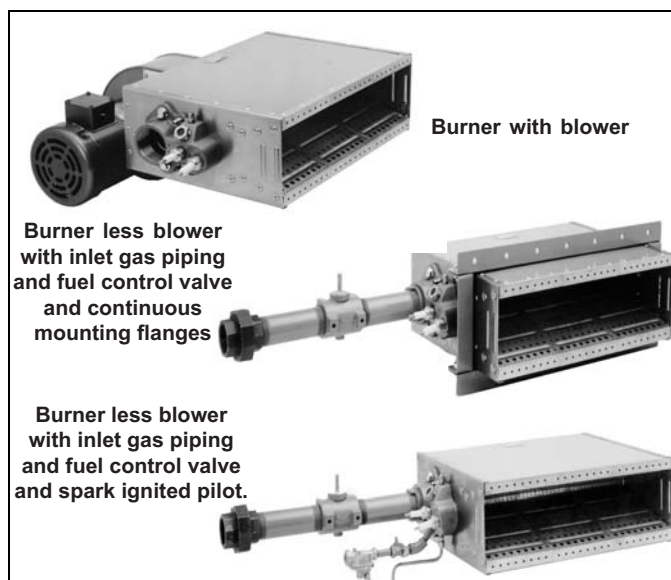

Figure 1.1 AirHeat Burner

Audience

This manual has been written for personnel already familiar with all aspects of a gas burner and it's add-on components, also referred to as the burner package.

These aspects are:

- Design / Selection
- Use
- Maintenance

The audience is expected to be qualified and have experience with this type of equipment and its working environment.

Purpose

The purpose of this manual is to make sure that the design of a safe, effective and trouble-free system is carried out.

AirHeat Documents

Installation Guide 135

- This document

Datasheet, Series 135

- Available for individual AH models
- Required to complete design and selection

Design Guide 135

- Used with Datasheet to design burner system

Related Documents

- EFE 825 (Combustion Engineering Guide)
- Eclipse Bulletins and Info Guides: 684, 710, 732, 756, 760, 902, 930

Important notices which help provide safe burner operation will be found in this section. To avoid personal injury and damage to the property or facility, the following warnings must be observed. All involved personnel should read this entire manual carefully before attempting to start or operate this system. If any part of the information in this manual is not understood, contact Eclipse before continuing.

Safety Warnings



DANGER

- **The burners covered in this manual are designed to mix fuel with air and burn the resulting mixture. All fuel burning devices are capable of producing fires and explosions when improperly applied, installed, adjusted, controlled or maintained.**
- **Do not bypass any safety feature; fire or explosion could result.**
- **Never try to light the burner if it shows signs of damage or malfunction.**



WARNING

- **The burner is likely to have HOT surfaces. Always wear protective clothing when approaching the burner.**
- **Eclipse products are designed to minimize the use of materials that contain crystalline silica. Examples of these chemicals are: respirable crystalline silica from bricks, cement or other masonry products and respirable refractory ceramic fibers from insulating blankets, boards, or gaskets. Despite these efforts, dust created by sanding, sawing, grinding, cutting and other construction activities could release crystalline silica. Crystalline silica is known to cause cancer, and health risks from the exposure to these chemicals vary depending on the frequency and length of exposure to these chemicals. To reduce the risk, limit exposure to these chemicals, work in a well-ventilated area and wear approved personal protective safety equipment for these chemicals.**

NOTICE

- **This manual gives information for the use of these burners for their specific design purpose. Do not deviate from any instructions or application limits in this manual without written advice from Eclipse.**

Capabilities

Only qualified personnel, with good mechanical aptitude and experience with combustion equipment, should adjust, maintain, or troubleshoot any mechanical or electrical part of this system.

Operator Training

The best safety precaution is an alert and trained operator. Train new operators thoroughly and have them demonstrate an adequate understanding of the equipment and its operation. A regular retraining schedule should be administered to ensure operators maintain a high degree of proficiency.

Replacement Parts

Order replacement parts from Eclipse only. Any customer-supplied valves or switches should carry UL, FM, CSA, CGA and/or CE approval where applicable.

Installation

3

Introduction

In this chapter you will find information and instructions needed to install the burner and system components.

Handling & Storage

Handling

- Make sure that the area is clean.
- Protect the components from the weather, damage, dirt and moisture.
- Protect the components from excessive temperatures and humidity.
- Take care not to drop or damage components.

Storage

- Make sure that the components are clean and free of damage.
- Store the components in a cool, clean, dry room.
- After you have made sure that everything is present and in good condition, keep the components in the original package as long as possible.

Approval of Components

Limit Controls & Safety Equipment

All limit controls and safety equipment must comply with all applicable local codes and/or standards and must be listed for combustion safety by an independent testing agency. Typical application examples include:

- American: NFPA 86 with listing marks from UL, FM, CSA
- European: EN 746-2 with CE mark from TuV, Gastec, Advantica

Electrical Wiring

All the electrical wiring must comply with all applicable local codes and/or standards such as:

- NFPA Standard 70
- IEC60364
- CSA C22
- BS7671

Gas Piping

All the gas piping must comply with all applicable local codes and/or standards such as:

- NFPA Standard 54
- ANSI Z223
- EN 746-2

Where to Get the Standards:

The NFPA Standards are available from:

National Fire Protection Agency
Batterymarch Park
Quincy, MA 02269
www.nfpa.org

The ANSI Standards are available from:

American National Standard Institute
1430 Broadway
New York, NY 10018
www.ansi.org

The UL Standards are available from:

333 Pfingsten Road
Northbrook, IL 60062
www.ul.com

The FM Standards are available from:

1151 Boston-Providence Turnpike
PO Box 9102
Norwood, MA 02062
www.fmglobal.com/approvals

Information on the EN standards and where to get them is available from:

Comité Européen de Normalisation

Stassartstraat 36
B-1050 Brussels
Phone: +32-25196811
Fax: +32-25196819
www.cen.eu

Comité Européen de Normalisation Electronique

Stassartstraat 36
B-1050 Brussels
Phone: +32-25196871
Fax: +32-25196919
www.cenelec.org

Checklist Before Installation

Intake

To admit fresh combustion air from outdoors, provide an opening in the room of at least one square inch per 4,000 Btu/h (1.17 kW). If there are corrosive fumes or materials in the air, then supply the burner with clean air from an uncontaminated area, or provide a sufficient air filtering system. Observe ambient temperature limits as stated in Datasheet 135.

There must be a minimum of 18% O₂ present in the process air flow to ensure proper burner performance.

Exhaust

Do not allow exhaust fumes to accumulate in the work area. Provide some positive means for exhausting from the furnace and the building.

Access

Make sure that you install the burner in such a way that you can gain easy access for inspection and maintenance.

Environment

Make sure the local environment matches the original operating specifications. Check the following items:

- Voltage, frequency and stability of the electrical power
- Type and supply pressure of the fuel
- Availability of enough fresh, clean combustion air
- Humidity, altitude and temperature of air
- Presence of damaging corrosive gases in the air
- Prevent direct exposure to water

Burner Mounting

NOTE: Mounting dimensions for all mounting options are found in Datasheet 135.

Guidelines for all Mounting Options

- Center the burner in the duct.
- Allow a minimum of 41" (1042 mm) from the burner to the nearest point of possible flame impingement at an input of 1,000,000 Btu/h (961 kW) and dP air = 1.0" w.c. See Datasheet 135 for more information about flame lengths at other burner settings.
- On burners longer than 36" (914 mm), use a hanger or a pedestal to support the blower and motor.

- The duct structure must be strong enough to support the weight of the burner. If necessary, reinforce the mounting area.
- Process air velocity must be within the limits stated in Datasheet 135.

In Duct Mounting

When laying out the duct, allow enough length downstream of the burner to avoid flame impingement. See Datasheet 135 for flame lengths.

Provide at least 3 inches (76 mm) clearance between the burner and the top, bottom and sides of the duct.

Profile plates are not required for good burner operation, but uniform velocity must be maintained for the full length of the burner. If velocity is not uniform, profile plates can be used to correct this condition.



- **Profile plates should be positioned flush with the firing end of the burner. If necessary, the plates can be located up to 0.5 inches (13 mm) back from the firing end, but under no circumstances should they be in front of the burner.**

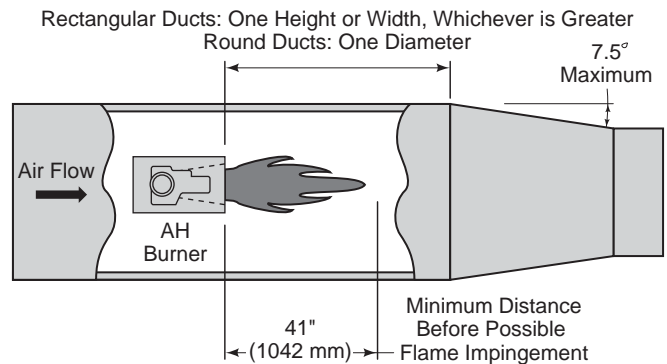

Figure 3.1. Minimum Distance Before Transition

Slot Firing

Firing end of the burner must extend into the duct.

Continuous Mounting (Sealed Firing)

Provide an opening in the duct 0.5 inches (13 mm) larger than the external burner dimensions. This will leave a 0.25 inch (6 mm) gap on all four sides. The customer must supply a suitable gasket between the mounting flange and the duct wall.

If the insulation is one inch (25 mm) or greater in thickness, it must be beveled away from the left and right end plates at approximately 45°.

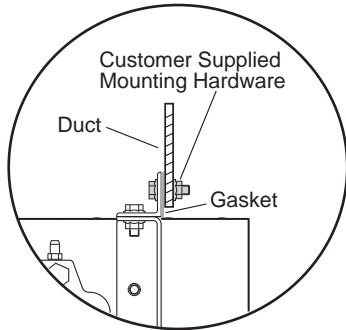

Figure 3.2. Continuous Mounting (Side View)

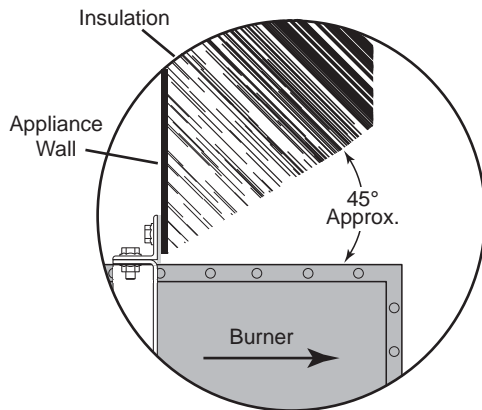

Figure 3.3. Continuous Mounting (Top View)

Burner Piping

The burner is factory assembled and shipped as ordered.

NOTE: If it is necessary to redirect piping, the burner may be inverted. Burner, fuel control BV and blower are not position conscious. All other items, i.e. valves, switches, actuators, etc. must be installed in accordance with the manufacturer's requirements.

Supply Piping

- Locate the valve train close to the burner. The gas must reach the burner during the fixed trial for ignition.
- Sufficiently size shut-off valves in the valve train.
- Make sure piping is large enough.
- Minimize piping elbows.

Pipe Connections

- Installation of a pipe union in the gas line is recommended to simplify burner removal
- Use of flexible pipe is optional.

NOTE: Flexible pipe causes higher pressure drops than standard pipe. Consider this when sizing your gas lines.

Piping Support

Use brackets or hangers to support the gas piping. If you have questions, consult your local gas company.

Control Motor

Install a control motor to modulate the gas control valve if not previously installed on the burner.

Installing the Flame Sensor

There are two different types of flame sensors; UV scanner and flame rod.

UV Scanner

Each AirHeat burner is capable of UV flame monitoring. The burner will not come equipped with a UV scanner. A 1/2" NPT connection is provided on each AirHeat burner for the connection of the UV scanner.

For detailed information on how to install and connect an Eclipse UV Scanner, refer to:

- Straight UV Scanner; Bulletin / Information Guide 854
- 90° UV Scanner; Bulletin / Information Guide 852
- Self-Check UV Scanner; Bulletin / Information Guide 856

Flame Rod

If the flame rod option was selected when the burner was ordered, the burner will be delivered with a flame rod already installed on the burner.

For detailed information on how to install and connect a flamerod, refer to Bulletin / Information Guide 832.

Checklist After Installation

To verify the system was properly installed, perform the following checks:

1. Be sure there are no leaks in the gas lines.
2. Be sure all the components contained in the flame monitoring and control systems are properly installed. This includes verifying that:
 - all the switches are installed in the correct locations.
 - all wiring, pressure, and impulse lines are properly connected.
3. Be sure all components of the spark ignition system are installed and functioning properly.
4. Be sure the blower rotates in the proper direction. If the rotation is incorrect, have a qualified electrician rewire the blower to rotate in the proper direction.
5. Be sure all valves are installed in the proper location and correctly oriented relative to the flow direction.

Prepare for Adjustment

After installation of the burner system components is complete, the following steps should be followed in order to prepare for adjustment:

1. Set the air flow switch so that it drops out at 20% below the maximum pressure of the combustion air blower.
2. Set the low gas pressure switch at 20% below the gas pressure measured at the inlet to the main gas valve train.
3. Set the high gas pressure switch at 20% above the gas pressure measured at the inlet to the main gas valve train.
4. Close all manual valves feeding the burner.
5. Try to ignite the burner before the purge and other timers have finished their cycles. Make sure that the flame monitoring system indicates a flame failure.
6. Trip out the pressure switches and other limit interlocks. Make sure that the main gas valve train closes.



DANGER

- **If simulated limits or simulated flame failures do not shut down the fuel system within the required failure response time, immediately correct the problem before proceeding.**

Adjustment, Start and Stop

4

In this chapter, you will find instructions on how to adjust, start, and stop the burner system. Become familiar with burner control methods before attempting to make adjustments.



DANGER

- The AirHeat burners are designed to mix fuel with air and burn the resulting mixture. All fuel burning devices are capable of producing fires and explosions if improperly applied, installed, adjusted, controlled, or maintained.
- Do not bypass any safety feature; fire or explosion could result.
- Never try to light a burner if it shows signs of damage or malfunction.

Burner Adjustment

If you are adjusting an AirHeat burner for the first time, you must follow these steps

1. Reset the System
2. Set the Air Flow
3. Ignite the Burner
4. Set High Fire Gas
5. Set Low Fire Gas
6. Verify Gas Settings
7. Stop Procedure

Step 1: Reset the System

1. Start the circulating duct fan
2. Close all the burner gas valves - manual and automatic
3. Start the combustion air blower

Step 2: Set the Air Flow

Measure the air pressure drop across the burner between Taps A and C. See Datasheet 135.

Turn the disc on the blower air inlet until the air pressure is between 0.6" w.c. (1.5 mbar) minimum and 1.2" w.c. (3.0 mbar) maximum. For a given input, lower air pressure

drops will produce a longer flame, and higher drops will produce a shorter flame with slightly higher CO levels.

There are two separate ignition procedures which depend upon whether or not a pilot is installed on the burner. Each procedure is unique and both are outlined below.



WARNING

- Both procedures assume that a flame monitoring control system is installed and is serviceable.

Step 3: Ignite the Burner

Direct Spark Ignition

1. Drive the gas control valve to low fire.

NOTE: All AirHeat burners are limited to direct spark ignition at inputs below 60% of maximum.

2. Be sure combustion air blower is running.
3. Open all manual gas valves feeding the burner.
4. Initiate the ignition sequence through the flame monitoring control system.
5. Verify that the burner has ignited.
6. If the burner does not ignite.
 - a. Try to ignite again to purge the air out of the gas piping.
 - b. If the burner does not ignite after one or two additional ignition attempts, see the Maintenance and Troubleshooting section of this manual.

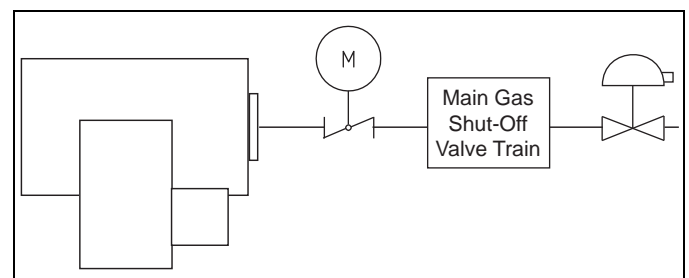

Burner Equipped with Spark Ignited Pilot

NOTE: Ignition is possible at all inputs using spark ignited pilot.

1. Drive the gas control valve to low fire.
2. Be sure combustion air blower is running.
3. Open all pilot gas valves including the handle of the adjustable port pilot gas cock.

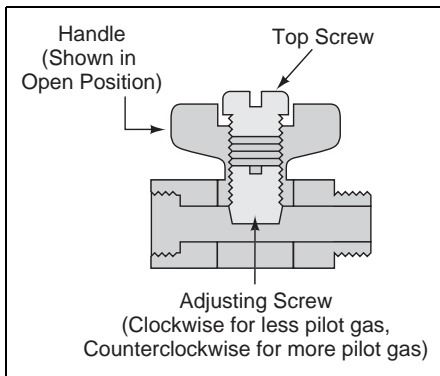

4. Verify that the pilot has ignited.
5. Initiate the ignition sequence through the flame monitoring control system.
6. If the pilot does not ignite:
 - a. Try to ignite again to purge the air out of the gas piping.
 - b. If the pilot does not ignite after one or two additional ignition attempts, see the Maintenance and Troubleshooting section of this manual.

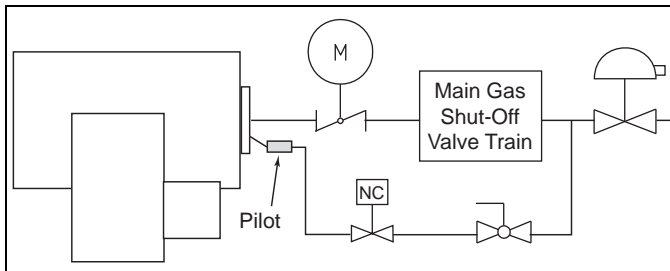

Step 4: Set High Fire Gas



- This procedure is written with the assumption the burner has a flame monitoring control system installed and operating. A proper purge cycle must be part of the system and purge timing should not be bypassed.

1. If the burner is ignited, set the main gas pressure regulator for 10" w.c. (25 mbar) outlet pressure.

2. Drive the main gas control valve to high fire position (full open).
3. Verify air flow with the burner firing. If necessary, repeat Step 2 of "Set Air Flow" above.
4. Make sure that pressure Taps B and C are open.
5. Connect the manometer to Taps B and C.
6. Measure the gas differential pressure.
7. Use the fuel ΔP curve from Datasheet 135 for the gas being used to find the differential gas pressure needed at high fire.
8. Adjust the outlet pressure from the main gas pressure regulator to achieve the desired gas flow.
9. Once the chamber conditions (pressure and temperature) stabilize, repeat Steps 3 through 8.
10. Remove the manometer.
11. Close the pressure taps.

Step 5: Set Low Fire Gas

1. Drive the main gas control valve to low fire.
2. Adjust the control valve linkage to provide the desired low fire gas flow.

NOTE: It is very difficult to measure the very low gas pressures experienced at low fire, and it may be necessary to rely on visual inspection of the flame. This is especially true when gas turndowns in excess of 20:1 are being used. The main intent is to provide a stable flame with good flame signal that will not cause the chamber temperature to overshoot.

Step 6: Verify Gas Settings

Make sure that all settings are still the same after cycling the system several times between high and low fire.

Step 7: Stop Procedure



- Do not turn the combustion air blower off until the chamber temperature is below 250°F (121°C). This will prevent hot gases from back flowing into the burner and blower causing damage to the burner.

1. Stop the burner through the burner control system.
2. Run the combustion air blower until the chamber temperature drops below 250°F (121°C).
3. Shut off the combustion air blower.
4. Close all manual gas valves to the burner.

Maintenance and Troubleshooting

5

This section is divided into two parts. The first part describes the maintenance procedures, and the second part helps you to identify problems that may occur and gives recommendations on how to solve these problems.

Preventative maintenance is the key to a reliable, safe and efficient system. The following are suggested guidelines for periodic maintenance. Burners in severe environments or operational conditions should be checked more frequently.

NOTE: The monthly and yearly lists are an average interval. If your environment is dirty, then the intervals may be shorter. Check with local authorities having jurisdiction on their recommended maintenance schedules.



CAUTION

- Turn off the power to the burner and controls before proceeding with burner inspection.

Monthly Checklist

1. Inspect flame-sensing devices for good condition and cleanliness.
2. Check for proper air/gas pressures. Refer to Datasheet 135.
3. Test all alarms for proper signals.
4. Check and clean igniter electrodes.
5. Check the air control valve for smooth, trouble free operation and adjustment.
6. Check for the proper operation of ventilating equipment.
7. Test interlock sequence of all safety equipment and manually make each interlock fail, noting that related equipment closes or stops as specified by the manufacturer. Test flame safeguard by manually shutting off gas to burner.
8. Test all manual fuel valves for operation.
9. Clean and/or replace the combustion air blower filter.
10. Inspect and clean the combustion air blower rotor.

Yearly Checklist

1. Test (leak test) safety shut-off valves for tightness of closure.
2. Test pressure switch settings by checking switch movements against pressure settings and compare these with the actual impulse pressure.
3. Visually check ignition cable and connectors.
4. Inspect impulse piping for leaks.
5. Be sure the following components are not damaged or distorted:
 - the burner bodies and air wings
 - the igniter
 - the flame sensors

Recommended Spare Parts

To make sure that the downtime of the system is as short as possible in case of a failure, you should keep a stock of spare parts. Please refer to the Eclipse Product Information Center (EPIC) for a full listing of spare parts: <http://www.eclipsenet.com/products>

Troubleshooting

Problem	Possible Cause	Solution
Cannot initiate a start sequence.	Air pressure switch has not made contact.	Check air pressure switch adjustment. Check air filter. Check blower rotation. Check outlet pressure from blower.
	High or low gas pressure switch has activated.	Check incoming gas pressure. Adjust gas pressure if necessary. Check pressure switch setting and operation.
	Purge cycle not completed.	Check flame safeguard system or purge timer.
	Malfunction of the flame safeguard system (e.g. shorted-out flame sensor or electrical noise in the sensor line).	Have a qualified electrician troubleshoot and correct the problem.
	No power to the control unit.	Have a qualified electrician troubleshoot and correct the problem.
	Main power is off.	Be sure the main power to the system is switched to the "On" position.
Start-up sequence runs but burner does not light.	PILOT IGNITION ONLY	
	Gas Pressure into pilot regulator is too low.	Check the outgoing gas pressure of the main regulator; increase if necessary.
	Pilot gas cock is closed.	Open the pilot gas cock.
	Pilot solenoid valve does not open.	Have a qualified electrician check the power supply to the solenoid.
	Gas adjusting valve is set too low.	Increase the gas flow.
	Air in the pilot gas line.	Repeat startup several times to purge air from the gas line.
	PILOT IGNITION OR DIRECT SPARK	
	No ignition. Attempting to ignite at inputs greater than 60% (direct spark).	Reduce the start point gas flow. Verify the control circuit.
	No ignition. Weak or non-existent spark.	Verify that the ignition transformer is a 6000 - 8000 volt transformer, not a half-wave.
	No ignition. There is no power to the ignition transformer.	Restore the power to the ignition transformer.
	No ignition. Open circuit between the ignition transformer and the igniter.	Repair or replace the wiring to the igniter.
	No ignition. The igniter needs cleaning.	Clean the igniter.
	No ignition. The igniter is not correctly grounded to the burner.	Clean the threads on the igniter and the burner. NOTE: Do not apply grease to the threads on the igniter.
	No ignition. Igniter insulator is broken. Igniter is grounding out.	Inspect the igniter. Replace if broken.
Not enough gas. The gas flow into the burner is too low.	Check start-up settings. Adjust the low fire settings if necessary.	

Problem	Possible Cause	Solution
Start-up sequence runs but burner does not light (continued)	Not enough gas. The gas valve does not open.	Check the wiring to the automatic gas shut-off valve. Check the output from the flame safeguard. Open the manual gas cock.
	No flame signal. Broken flame rod.	Replace if necessary.
	No flame signal. Dirty UV scanner lens.	Inspect and clean sensor.
	No flame signal. Flame rod is grounding out.	Verify that the flame rod is installed correctly and that it is the correct length.
The low fire flame is weak or unstable.	Not enough gas flowing to the burner.	Check startup settings and adjust to increase the gas flow.
	Incorrect air flow setting.	Check air pressure drop across the burner and adjust.
The burner does not go to high fire.	Not enough gas pressure out of the main gas regulator	Adjust the pressure regulator so the pressure is provided as stated in Datasheet 135.
	Gas pressure drops as input is increased.	Check for clogging of valves and regulators in gas line. Pressure regulator may be incorrectly sized. Replace if necessary.
	Main gas control valve is not functioning.	Check the actuator and linkage.
The burner does not achieve capacity.	Main gas control valve is not functioning.	Check the actuator and linkage.
	Burner is firing below rated input	Check gas pressure differential. Adjust main gas pressure regulator as necessary.
	Burner gas holes are plugged.	Inspect gas holes for dirt or lint as needed.
Main flame is uneven along the length of the burner.	Air pressure drop/velocity is too low.	Increase air pressure drop.
	Poor air distribution in duct.	Check profiling and duct obstructions.
	Air wings are dirty; holes are clogged.	Inspect and clean air wings if necessary.
Main flame is yellow and long at high fire.	Gas pressure too high at burner inlet.	Check gas pressure against design. Adjust main gas pressure regulator.
	Air wings are dirty; holes are clogged.	Inspect and clean air wings if necessary.
	Air pressure drop/velocity too low.	Open air damper on combustion air blower.
CO emission is too high.	Burner is outside the range specified in Datasheet 135.	Adjust burner settings.
	Process air velocity exceeds limits given in Datasheet 135.	Bring velocity within limits; adjust process air blower.

Appendix

Conversion Factors

Metric to English

From	To	Multiply By
actual cubic meter/h (am ³ /h)	actual cubic foot/h (acfh)	35.31
normal cubic meter/h (Nm ³ /h)	standard cubic foot /h (scfh)	38.04
degrees Celsius (°C)	degrees Fahrenheit (°F)	(°C x 9/5) + 32
kilogram (kg)	pound (lb)	2.205
kilowatt (kW)	Btu/h	3415
meter (m)	foot (ft)	3.281
millibar (mbar)	inches water column ("w.c.)	0.402
millibar (mbar)	pounds/sq in (psi)	14.5 x 10 ⁻³
millimeter (mm)	inch (in)	3.94 x 10 ⁻²
MJ/Nm ³	Btu/ft ³ (standard)	26.86







Metric to Metric



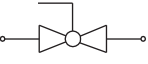
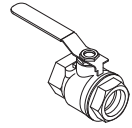
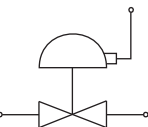
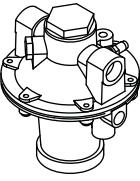

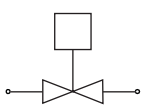
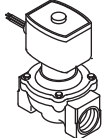



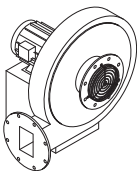

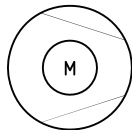
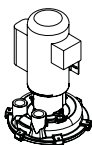
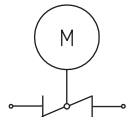
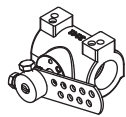
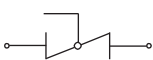
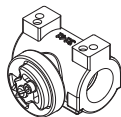
From	To	Multiply By
kiloPascals (kPa)	millibar (mbar)	10
meter (m)	millimeter (mm)	1000
millibar (mbar)	kiloPascals (kPa)	0.1
millimeter (mm)	meter (m)	0.001

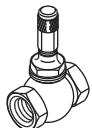
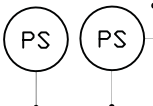
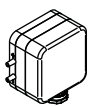
English to Metric

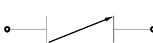
From	To	Multiply By
actual cubic foot/h (acfh)	actual cubic meter/h (am ³ /h)	2.832 x 10 ⁻²
standard cubic foot /h (scfh)	normal cubic meter/h (Nm ³ /h)	2.629 x 10 ⁻²
degrees Fahrenheit (°F)	degrees Celsius (°C)	(°F - 32) x 5/9
pound (lb)	kilogram (kg)	0.454
Btu/h	kilowatt (kW)	0.293 x 10 ⁻³
foot (ft)	meter (m)	0.3048
inches water column ("w.c.)	millibar (mbar)	2.489
pounds/sq in (psi)	millibar (mbar)	68.95
inch (in)	millimeter (mm)	25.4
Btu/ft ³ (standard)	MJ/Nm ³	37.2 x 10 ⁻³

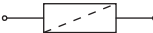
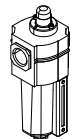
System Schematics

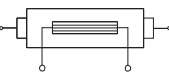
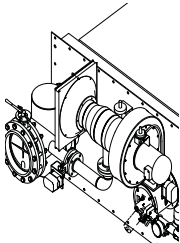
Symbol	Appearance	Name	Remarks	Bulletin/ Info Guide
		Gas Cock	Gas cocks are used to manually shut off the gas supply.	710
		Ratio Regulator	A ratio regulator is used to control the air/gas ratio. The ratio regulator is a sealed unit that adjusts the gas pressure in ratio with the air pressure. To do this, it measures the air pressure with a pressure sensing line, the impulse line. This impulse line is connected between the top of the ratio regulator and the burner body.	
		Main Gas Shut-Off Valve Train	Eclipse strongly endorses NFPA as a minimum.	790/791
		Pilot Gas Valve Train	Eclipse strongly endorses NFPA as a minimum.	790/791
		Automatic Shut-Off Valve	Shut-off valves are used to automatically shut off the gas supply on a gas system or a burner.	760
		Orifice Meter	Orifice meters are used to measure flow.	930
		Combustion Air Blower	The combustion air blower provides the combustion air to the burner(s).	610

Symbol	Appearance	Name	Remarks	Bulletin/ Info Guide
		Hermetic Booster	Booster is used to increase gas pressure.	620
		Automatic Butterfly Valve	Automatic butterfly valves are typically used to set the output of the system.	720
		Manual Butterfly Valve	Manual butterfly valves are used to balance the air or gas flow at each burner.	720
		Adjustable Limiting Orifice	Adjustable limiting orifices are used for fine adjustment of gas flow.	728/730
		Pressure Switch	A switch activated by rise or fall in pressure. A manual reset version requires pushing a button to transfer the contacts when the pressure set point is satisfied.	840
		Pressure Gauge	A device to indicate pressure.	940
		Check Valve	A check valve permits flow only in one direction and is used to prevent back flow of gas.	780
		Strainer	A strainer traps sediment to prevent blockage of sensitive components downstream.	
		Flexible Connector	Flexible connectors isolate components from vibration, mechanical, and thermal stresses.	
		Heat Exchanger	Heat exchangers transfer heat from one medium to another.	500
		Pressure Taps	Pressure taps measure static pressure.	

