

# *Eclipse BoostPak*

---

## *Packaged Gas Booster System*

*Model LS*  
*Version 3*

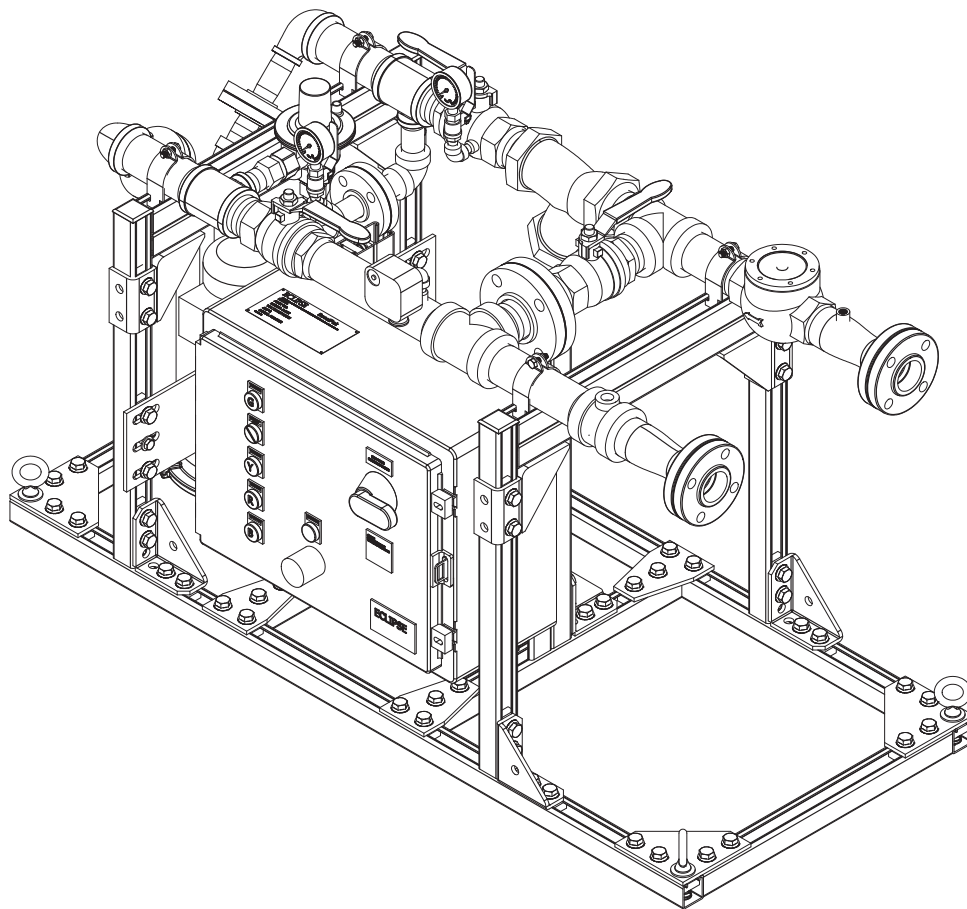

## **Copyright**

Copyright 2010 by Eclipse, inc. All rights reserved worldwide. This publication is protected by federal regulation and shall not be copied, distributed, transmitted, transcribed or translated into any human or computer language, in any form or by any means, to any third parties, without the express written consent of Eclipse, inc.

## **Disclaimer Notice**

In accordance with the manufacturer's policy of continual product improvement, the product presented in this brochure is subject to change without notice or obligation.

The material in this manual is believed adequate for the intended use of the product. If the product is used for purposes other than those specified herein, confirmation of validity and suitability must be obtained. Eclipse warrants that the product itself does not infringe upon any United States patents. No further warranty is expressed or implied.

## **Liability & Warranty**

We have made every effort to make this manual as accurate and complete as possible. Should you find errors or omissions, please bring them to our attention so that we may correct them. In this way we hope to improve our product documentation for the benefit of our customers. Please send your corrections and comments to our Technical Documentation Specialist.

It must be understood that Eclipse's liability for its product, whether due to breach of warranty, negligence, strict liability, or otherwise is limited to the furnishing of replacement parts and Eclipse will not be liable for any other injury, loss, damage or expenses, whether direct or consequential, including but not limited to loss of use,

income, or damage to material arising in connection with the sale, installation, use of, inability to use, or the repair or replacement of Eclipse's products.

Any operation expressly prohibited in this manual, any adjustment, or assembly procedures not recommended or authorized in these instructions shall void the warranty.

## **Document Conventions**

There are several special symbols in this document. You must know their meaning and importance.

The explanation of these symbols follows below. Please read it thoroughly.

## **How To Get Help**

If you need help, contact your local Eclipse representative. You can also contact Eclipse at:

1665 Elmwood Rd.  
Rockford, Illinois 61103 U.S.A.  
Phone: 815-877-3031  
Fax: 815-877-3336  
<http://www.eclipsenet.com>

Please have the information on the product label available when contacting the factory so we may better serve you.

|                                                                                                                                                  |                                                            |
|--------------------------------------------------------------------------------------------------------------------------------------------------|------------------------------------------------------------|
|  <b>ECLIPSE</b><br><small>Innovative Thermal Solutions</small> | <a href="http://www.eclipsenet.com">www.eclipsenet.com</a> |
| Product Name                                                                                                                                     |                                                            |
| Item #                                                                                                                                           |                                                            |
| S/N                                                                                                                                              |                                                            |
| DD MMM YYYY                                                                                                                                      |                                                            |



This is the safety alert symbol. It is used to alert you to potential personal injunt hazards. Obey all safety messages that follow this symbol to avoid possible injury or death.



Indicates a hazardous situation which, if not avoided, will result in death or serious injury.



Indicates a hazardous situation which, if not avoided, could result in death or serious injury.



Indicates a hazardous situation which, if not avoided, could result in minor or moderate injury.

**NOTICE**

Is used to address practices not related to personal injury.

**NOTE**

Indicates an important part of text. Read thoroughly.

---



# Table of Contents

|                                                  |           |
|--------------------------------------------------|-----------|
| <b>1 Introduction</b> .....                      | <b>4</b>  |
| Product Description .....                        | 4         |
| Audience .....                                   | 4         |
| Purpose .....                                    | 4         |
| Related Documents.....                           | 4         |
| <b>2 Safety</b> .....                            | <b>5</b>  |
| Safety Warnings .....                            | 5         |
| Capabilities.....                                | 5         |
| Operator Training .....                          | 5         |
| Replacement Parts.....                           | 5         |
| <b>3 Installation</b> .....                      | <b>6</b>  |
| Introduction.....                                | 6         |
| Handling & Storage .....                         | 6         |
| Checklist Before Installation .....              | 6         |
| Mechanical Installation .....                    | 6         |
| Piping Installation .....                        | 6         |
| Electrical Installation.....                     | 7         |
| Checklist After Installation .....               | 8         |
| <b>4 Commissioning</b> .....                     | <b>9</b>  |
| Introduction.....                                | 9         |
| Setting the Regulator.....                       | 9         |
| Operational Tests .....                          | 9         |
| Commissioning Record .....                       | 10        |
| <b>5 Operation</b> .....                         | <b>11</b> |
| Introduction.....                                | 11        |
| Alarm Silence .....                              | 11        |
| Shutdown .....                                   | 11        |
| <b>6 Maintenance &amp; Troubleshooting</b> ..... | <b>12</b> |
| Monthly Checklist .....                          | 12        |
| Yearly Checklist.....                            | 12        |
| Alarm Conditions .....                           | 12        |
| Wiring Diagram.....                              | 14        |
| Mechanical Drawing.....                          | 15        |
| Piping Schematics.....                           | 15        |
| Panel Layout .....                               | 17        |
| Spare Parts List.....                            | 17        |
| <b>Appendix</b> .....                            | <b>i</b>  |
| Conversion Factors .....                         | i         |
| Key to Schematics Drawings.....                  | ii        |

# Introduction

1

## Product Description

The Eclipse BoostPak is designed for installations when the gas pressure to a building is inadequate to operate the appliances. It provides a reliable cost-effective packaged solution for pumping low natural gas supply pressures up to meet the requirements of high performance combustion equipment. The discharge pressure is the total of the booster added pressure plus the incoming gas pressure.

The BoostPak is a completely integrated skid mounted package. It is factory assembled, wired, tested, and ready for field power and gas connections. The system includes but is not limited to a gas booster blower, check valve, gas pressure switch, isolating valves, inlet and outlet piping and flange connectors, pressure gauges, and control system all mounted, assembled, wired, and tested. All essential components for automatic operation are enclosed in an industrial control panel designed to meet local and national electrical codes.

Various standard options may be selected to configure a complete model number. The options determine the control modes, pressure boost, flow, and environmental conditions.

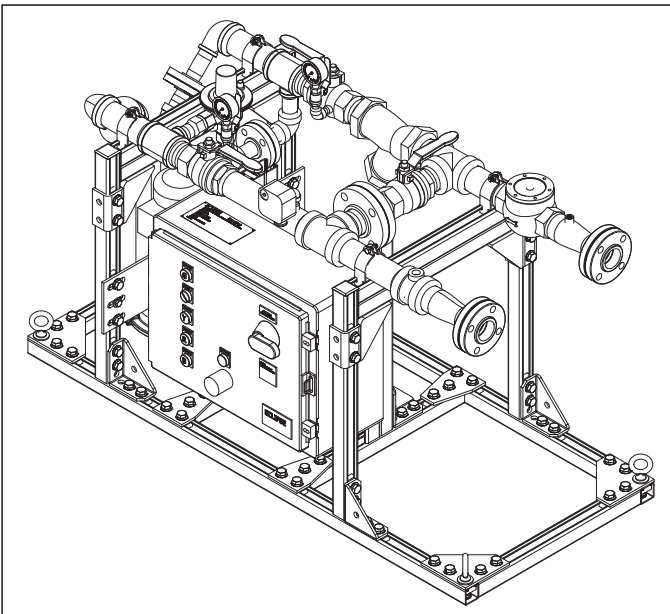

**Figure 1.1. Eclipse BoostPak**

## Audience

This manual has been written for personnel already familiar with all aspects of a gas booster system and its add-on components.

These aspects are:

- Installation
- Use
- Maintenance
- Safety

The audience is expected to be qualified and have experience with this type of equipment and its working environment.

## Purpose

The purpose of this manual is to make sure that you carry out the installation of a safe, effective and trouble-free system.

## BoostPak Documents

### **Installation Guide No. 630-1**

- This document

### **Datasheet No. 630-1**

- Available for BoostPak model LS
- Provides assembly drawing numbers
- Required to complete installation

### **System Drawings**

- 10024840 (LS1010)
- 10024841 (LS1515)
- 10024842 (LS2020)
- 10025020 (Control Panel)

## Related Documents

- EFE 825 (Combustion Engineering Guide)
- Eclipse Bulletins and Information Guides: 620, 710, 780, 940

# Safety

## 2

Important notices for safe operation of the BoostPak system will be found in this section. To avoid personal injury, damage to property or the facility, the following warnings must be observed. Read this entire manual before attempting to start the system. If any part of the information in this manual is not understood, contact Eclipse before continuing.

### Safety Warnings

#### **DANGER**

- **The BoostPak packaged gas booster systems, covered by this guide are designed to increase gas pressure to a gas utilization appliance. All fuel handling devices are capable of producing fires and explosions if improperly applied, installed, adjusted, controlled or maintained.**
- **Do not bypass any safety feature; fire or explosion could result.**
- **Never try to operate a BoostPak if it shows signs of damage or malfunction.**

#### **NOTICE**

- **This manual provides information in the use of the BoostPak for its specific design purpose. Do not deviate from any instructions or application limits described herein without written advice from Eclipse.**

### Capabilities

Only qualified personnel, with good mechanical aptitude and experience with combustion equipment, should adjust, maintain or troubleshoot any mechanical or electrical part of this system.

### Operator Training

The best safety precaution is an alert and trained operator. Train new operators thoroughly and have them demonstrate an adequate understanding of the equipment and its operation. A regular retraining schedule should be administered to ensure operators maintain a high degree of proficiency.

### Replacement Parts

Order replacement parts from Eclipse only. Any customer supplied valves or switches should carry UL, FM, CSA, CGA and/or CE approvals where applicable.

# Installation

## Introduction

In this chapter you will find information and instructions needed to install the BoostPak and system components. The following system drawings are shipped with the equipment: for LS1010, dwg. 10024840; for LS1515, dwg. 10024841; for LS2020, dwg. 10024842; and for the control panel, dwg. 10025020.



- All installation work must be carried out in compliance with current legislated standards.

## Handling & Storage

### Handling

- Make sure the area is clean.
- Inspect the system, ensure that all components are clean and free from damage.
- Use appropriate support and handling equipment when lifting the BoostPak.
- Protect the components from weather, damage, dirt and moisture.
- Protect the system and components from excessive temperatures and humidity.

### Storage

- Make sure the components are clean and free of damage.
- Store the components in a cool, clean, dry room.
- After making sure everything is present and in good condition, keep the components in original packages as long as possible.

## Checklist Before Installation

### Placement

The Eclipse BoostPak is completely factory piped, wired with controls, tested and ready for field connections. The system should be installed in an accessible ventilated location on a level concrete floor or substantial mounting pad. Place the BoostPak to avoid excessive numbers of bends and fittings in the interconnecting piping. Avoid locations subject to falling dirt and debris, or provide a guard to prevent objects from falling and lodging into the cooling fan of the booster motor.

## Access

The BoostPak location must allow easy accessibility for inspection and maintenance. Provide adequate space all around the BoostPak in order to facilitate servicing and field replacement of components. Avoid obstructing the open access to the control panel.

**NOTE:** There should be no less than 36" of clearance from the front of the control panel door and the swing of the door should not be obstructed from opening 120°. If local codes are different than these requirements, those codes should be adhered to during installation.

## Environment

Be sure the operating environment matches the original operating specifications. Check the following items:

- Voltage, frequency, and stability of electrical power
- Ambient temperature and humidity
- Area classification (non-hazardous or hazardous)
- Exposure to sunlight, water, ice, wind, and vibration

## Mechanical Installation

### Lift Points

Use lifting lugs on mounting base for all lifting. Do not use piping or supports as lift points unless designated by manufacturer labeling.

### Mounting

Bolt the unit base securely to the floor or mounting pad. Attachment parts are not included.

## Piping Installation

### Gas Piping

All gas piping must be done in accordance with the national fuel gas code, local utility company and municipal agency requirements. Protect and prevent contamination of the piping during installation.

**NOTE:** If it is necessary to redirect piping, make sure all devices are properly oriented with respect to flow direction and vertical (gravity) orientations.

**NOTE:** Avoid severe size reductions in pipe connections, unnecessary fittings, and excessive bends that may cause additional flow restriction and pressure loss.

Elbows within 5 pipe diameters may reduce pressure and capacity below operating requirements.

## Piping Support

Use brackets or hangers to support the gas piping. If you have questions, consult your local gas company.

## Initial Fitting

- Remove any shipping materials and inspect for foreign objects in the piping.
- Connect inlet gas piping from the utility supply to the inlet flange as indicated by directional arrows and system drawings.
- Connect the gas pipe requiring the boosted gas pressure feeding your appliance to the discharge gas pipe outlet flange, also indicated by label and system drawing.

## Vent Piping

The model LS BoostPak does not require vent piping. Vent piping may be required for components added to the system. Check the individual product datasheets for specific manufacturer's recommendations.

## Inlet Low Gas Manual Reset Pressure Switch

This switch may come already mounted and wired on the BoostPak, or it may be supplied as a kit to be remotely mounted. Install loose inlet gas low pressure switch kit in location determined by the utility company. Normally it is located downstream of the main regulator just inside the building where the supply pipe enters.

## Inlet High Gas Pressure Switch

If used, this optional switch may come already mounted and wired on the BoostPak, or it may be supplied as a kit to be remotely mounted. Install loose inlet gas high pressure switch kit in location determined by the specifying engineer. Normally it is located down-stream of the main regulator just inside the building where the supply pipe enters.

## Pressure Switch Settings

- Check and adjust the pressure switches as required.
- The utility company dictates the setting of the low inlet gas pressure switch typically at 3-4" w.c. to prevent operation when there is insufficient gas volume.
- The discharge gas pressure switch should be set 2-4" w.c. below the rated discharge pressure at the maximum flow conditions for the site application.
- If installed, the optional inlet high gas pressure switch should be set to 90% of the pressure where the sum of the inlet plus the rated boost equals the maximum rating of downstream equipment. (Alternately it can be set to 20% above the minimum requirement of the downstream equipment.)

## Leak Testing

The BoostPak is tested and leak tight at the factory, however, shipping and installation may cause joints to loosen. Check and test all piping for leaks.



- **Test pressure must not exceed 3 PSIG and the pressure gauges or any components with ratings less than the test pressure should first be isolated. Check the individual product datasheets for specific ratings.**

## Electrical Installation

### General

All electrical wiring must be done in accordance with the national electrical code, local utility company and municipal agency requirements. The schematics are shipped with the BoostPak. Contact Eclipse for replacement, drawing 10025020.

The BoostPak is pre-wired, therefore, only the electrical power supply and any externally supplied control devices must be connected. Depending on the specific model configuration, the external devices can include the appliance interlock contact and the low inlet gas pressure switch.

### Review Name Plate

Before making any electrical connections, compare the electrical supply circuit ratings at the installation site to those on the name plates of the BoostPak, control panel, and booster motor. The supply for the BoostPak model LS must be 120VAC nominal and must be capable of supplying the booster motor full load current of 2 amps and starting current of 7 amps.

### Terminal Check

During shipment, the control panel terminals may have loosened. Check the tightness of all connections in the panel and at the pressure switches.

### Supply Power Wiring

The incoming power to the control panel must be wired into the terminals as designated in the schematic diagram. The ground wire must be connected to the ground lug located next to the disconnect.

### Wiring for Continuous Operation

This control mode allows an operator to turn a local control panel switch on when pressure boost is needed and turn the switch off when the boost is not needed. For this mode, a jumper is installed between terminals 1321 and 2161.

## **Wiring for Appliance On Demand Operation, Start Circuit Interlock**

This control mode requires a customer supplied run interlock. It must be a dry (voltage free) contact that makes continuity when the booster is required and opens when the booster should shut down. Commonly used devices include: automatic time clock, flow switch, relay contact, or switch contact. For this mode, wire the contact between terminals 1321 and 2161. Be sure to remove any jumper connection between terminals if present.

## **Wiring for Flow Sensor Demand Control Operation**

This control mode is an option that is typically ordered and installed at the factory. If it has been supplied as a kit, refer to Data 630-FC and Installation Guide 630-FC.

## **Wiring for Inlet Low Gas Manual Reset Pressure Switch**

This switch may come already mounted and wired on the BoostPak, or it may be supplied as a kit to be remotely mounted. This switch is required by local utility company as a safety device. The kit version must be wired into the BoostPak control panel. Wire the low inlet gas pressure switch terminal 3 (COM) to panel terminal 1321, and switch terminal 2 (NO) to panel terminal 2121. Be sure to remove any jumper connection between these terminals if present.

## **Wiring for Inlet High Gas Pressure Switch**

If installed, this optional switch may come already mounted and wired on the BoostPak, or it may be supplied as a kit to be remotely mounted. The kit version must be wired into the BoostPak control panel. Wire the high inlet gas pressure switch terminal 3 (COM) to panel terminal 2161, and switch terminal 1 (NC) to panel terminal 2162. Be sure to remove the jumper wire between these terminals if present.

## **Alarm Output Wiring**

A terminal is provided to connect an external alarm. If used, wire the external alarm to panel terminal 2331 (hot) and 1323 (neutral). The external alarm should be rated for 120VAC and not exceed 2 amps.

## **Checklist After Installation**

Ensure the system was properly installed and verify:

- The skid is securely bolted to the floor or mounting pad and is rigid and level.
- There are no loosely mounted components.
- There are no leaks in the gas lines.
- The external gas piping has appropriate brackets and is not supported by the BoostPak.
- Verify correct orientation of gas piping – from utility point of entry to BoostPak inlet, from BoostPak outlet to the appliance.
- Verify sufficient unobstructed access to the control panel and booster motor.
- Verify electrical power supply and all external devices are wired correctly.
- Verify tightness of all terminal connections on all devices.
- Verify the gas pressure switch(es) are installed in the correct location and confirm the proper settings.
- Verify all device orientations are correct with respect to flow direction.
- Check for and clean out debris on the cooling fan of the booster motor.
- Inspect and remove any metal debris that may have attached to the magnetic motor coupling on the booster.



# Commissioning

# 4

## Introduction

In this chapter you will find information and procedures for the first operation and adjustment of the BoostPak.



### **WARNING**

- **Only qualified personnel, with good mechanical and electrical aptitude should adjust, maintain, or troubleshoot any mechanical or electrical part of this system. They should have knowledge and experience with combustion equipment including piping, valves, motors, blowers, boosters, switches, control panels and wiring.**

These instructions rely on the expertise of the person performing the start up. If you do not understand any portion of this procedure or do not feel qualified, stop and call Eclipse.

Before applying the site electrical power supply to the BoostPak control panel:

- Turn off the main disconnect switch.
- Turn the HAND/OFF/AUTO control switch to OFF.

Turn the control panel main disconnect switch on and verify that the panel instrumentation has power. Momentarily turn the HAND/OFF/AUTO switch to HAND position to “bump” the motor starter such that the motor just starts to turn and rotates slowly. Observe the direction of rotation of the fan blades on the rear of the booster motor. The fan blades should be turning in a clockwise direction. If rotation direction is incorrect, have a qualified electrician rewire the incoming power for the proper direction.

Before applying the site gas supply initially set the manual ball valves:

- Open the bypass valve if supply is required downstream of the BoostPak
- Open the booster inlet valve
- Close the booster outlet valve

Turn on the gas supply to the BoostPak and press the reset on the Inlet Low Gas Manual Reset Pressure Switch.

## Setting the Regulator

If the regulator needs to be adjusted, carefully open the cap on top of the regulator stem (do not damage gasket).

- To decrease the BoostPak outlet pressure, screw the adjusting disc inside the stem counterclockwise. It will move outwards towards the top of the stem.
- To increase BoostPak outlet pressure, screw the adjusting disc clockwise. Do not adjust the disc close to the bottom of the stem; stop well before getting to the end of the threads.

Replace gasket and regulator cap. Then set the manual ball valves:

- Open the booster outlet valve.
- Be sure the inlet valve is still open.
- Close BoostPak bypass valve.

## Operational Tests

Test the operation of the BoostPak and verify:

- **DISCHARGE PRESSURE SWITCH:** The low gas light blinks and alarm comes on with the outlet valve closed. The booster should remain running.
  - **LOW INLET GAS PRESSURE SWITCH:** The booster stops, the low gas light and alarm comes on when the Inlet Low Gas Manual Reset Pressure Switch is adjusted above the inlet gas supply. Adjust this switch back to the original specified set point and observe that the system will not restart unless the pressure switch is first manually reset.
  - **APPLIANCE RUN INTERLOCK:** For appliance on demand operation mode, turn the control switch to AUTO and test that the system runs when the appliance interlock makes contact.
1. Run system at nominal flow rating.
  2. Verify pressure increase from booster is correct. Read the inlet and outlet pressure gauges on the BoostPak. Subtract the inlet from outlet pressure to verify added pressure agrees with the datasheet.
  3. Verify that outlet pressure is sufficient for appliance operation.
  4. Verify flow is sufficient for appliance via gas metering located at the appliance (not included with BoostPak).
  5. Run system to minimum flow condition; verify flows and pressures are within acceptable range.
  6. Record all setup data as an aid for future troubleshooting and setup operations.

**Commissioning Record**

**Models LS**

**Nameplate Information**

BoostPak Model \_\_\_\_\_

Serial Number \_\_\_\_\_

Control Panel Serial Number \_\_\_\_\_

**Mechanical Installation**

Ambient Temperature \_\_\_\_\_

Mounting Secure, Rigid, Level \_\_\_\_\_

Supply and Feed Piping Supported \_\_\_\_\_

Leak Test (Do not exceed 3 PSI) \_\_\_\_\_

Low Inlet Gas Pressure Switch Setting \_\_\_\_\_

High Inlet Gas Pressure Switch Setting \_\_\_\_\_

Outlet Gas Pressure Switch Setting \_\_\_\_\_

**Performance**

Gas Inlet Pressure \_\_\_\_\_

BoostPak Outlet Pressure, Low Flow \_\_\_\_\_

BoostPak Outlet Pressure, High Flow \_\_\_\_\_

Power Supply Voltage \_\_\_\_\_

Booster Motor Current \_\_\_\_\_

I certify this equipment is installed per the requirements of the manufacturer and that it is performing to its specifications.

By: \_\_\_\_\_ Date: \_\_\_\_\_

# Operation

# 5

## Introduction

In this chapter, you will find instructions on how to start and stop the booster system. Become familiar with booster control methods before operating the equipment.



**DANGER**

- **The BoostPak system, described herein, is designed to increase gas pressure to an appliance. All fuel handling devices are capable of producing fires and explosions if improperly applied, installed, adjusted, controlled, or maintained.**
  - **Do not bypass any safety feature; fire or explosion could result. Never try to operate a BoostPak if it shows signs of damage or malfunction.**
1. Be sure the inlet and outlet valves are open and bypass valve is closed. Turn the main disconnect switch on.
  2. The green POWER ON light comes on.
  3. Check for ALARM conditions and correct before proceeding. See Alarm Conditions in the troubleshooting section of this guide.
  4. Turn the control switch to AUTO.

The BoostPak is in operation.

- For Continuous Operation mode, the booster will run within 15 seconds of the switch operation.
- For Appliance On Demand mode, the booster will run within 15 seconds of the closure of the appliance run interlock contact.

The booster motor starter contact closes, the motor starts running, and the yellow BOOSTER ON light comes on. The LOW GAS light will flash on and off until the outlet gas pressure switch makes contact. If it does not make contact within 15 seconds, the red LOW GAS light comes on steady and the alarm sounds.

## Alarm Silence

To silence the alarm, press the ALARM SILENCE button.

## Shutdown

The booster can be stopped by:

- Opening the run interlock contact (appliance dedicated control mode)
- Turning the control switch to off
- Turning the main disconnect switch off

When shutting the system down to prevent operation, turn the main disconnect switch off and turn off the main power supply to the control panel.

# Maintenance & Troubleshooting

## Monthly Checklist

- Inspect and tighten loose mechanical components
- Look for signs of damage and repair
- Test operation if the unit has not run and check for excessive vibration
- Clean the booster motor housing and cooling fan
- Wipe clean the control panel surfaces

## Yearly Checklist

- Clean y-strainer screen
- Check inlet and outlet pressure switch settings
- Check and compare inlet and outlet pressures to the initial commissioning record sheet
- Measure and compare the power supply and motor current to the record sheet
- Perform operational test in the commissioning section of this guide

## Alarm Conditions

Certain conditions will cause the ALARM to come on. To silence the alarm, press the ALARM SILENCE push button.

- INLET LOW GAS MANUAL RESET PRESSURE SWITCH opens due to low utility line pressure. The LOW GAS light comes on and the booster motor will stop running. When the pressure is restored, this switch must be manually pushed to reset its contact.
- DISCHARGE GAS PRESSURE SWITCH fails to make contact within 15 seconds. The LOW GAS light comes on; the booster will not shut down.
- If the motor wiring or internal temperature switch opens, then the motor will stop causing the discharge gas pressure switch to open. Then the ALARM and LOW GAS light come on.
- A booster motor overload condition will shut down the booster and the MOTOR FAULT light and ALARM will come on.

| Problem                        | Possible Cause                                           | Solution                                                                                                                                         |
|--------------------------------|----------------------------------------------------------|--------------------------------------------------------------------------------------------------------------------------------------------------|
| No POWER ON light              | Main supply power is off                                 | Be sure main power to the system is switched "on".                                                                                               |
|                                | Main disconnect switch is off                            | Turn the control panel main disconnect switch on.                                                                                                |
|                                | Loose connection                                         | Check for voltage on panel terminals, turn off main power and inspect, tighten wire connection.                                                  |
|                                | Blown fuse                                               | Verify that all fuses are good and properly installed. If blown, have a qualified electrician determine the cause and fix before replacing fuse. |
| Cannot initiate start sequence | Inlet low gas manual reset pressure switch has activated | Check incoming gas pressure: adjust if necessary.                                                                                                |
|                                |                                                          | Check pressure switch setting and operation.                                                                                                     |
|                                |                                                          | If used, check that the pressure switch isolating valve is not closed.                                                                           |

| <b>Problem</b>                                                      | <b>Possible Cause</b>                                                   | <b>Solution</b>                                                                                                                                               |
|---------------------------------------------------------------------|-------------------------------------------------------------------------|---------------------------------------------------------------------------------------------------------------------------------------------------------------|
| Cannot initiate start sequence                                      | If used, Inlet High Gas Pressure Switch has activated                   | Normal operation, when the inlet pressure drops below the switch setting, then the system will start.                                                         |
|                                                                     | Motor starter overload tripped                                          | Check for defective motor, reset overload unit.                                                                                                               |
|                                                                     | Appliance interlock not made or jumper (continuous operation) is loose. | Have qualified electrician verify and rewire.                                                                                                                 |
| Startup sequence runs, but booster shuts down after several minutes | Booster motor overload, thermal cut-out switch open                     | Verify voltage supply, booster motor rotation direction, sufficient inlet pressure, and that inlet/outlet valves are open. Let motor cool and reset overload. |
| Cannot achieve full capacity                                        | Inlet/outlet piping too restricted                                      | Rerun larger/straighter pipe runs.                                                                                                                            |
|                                                                     | Inlet pressure too low                                                  | Consult with utility company.                                                                                                                                 |
|                                                                     | Booster motor rotation incorrect                                        | Verify and have qualified electrician rewire.                                                                                                                 |
|                                                                     | Manual inlet or outlet valve is partially closed                        | Open inlet/outlet valves fully.                                                                                                                               |

# BoostPak Model LS Wiring Diagram

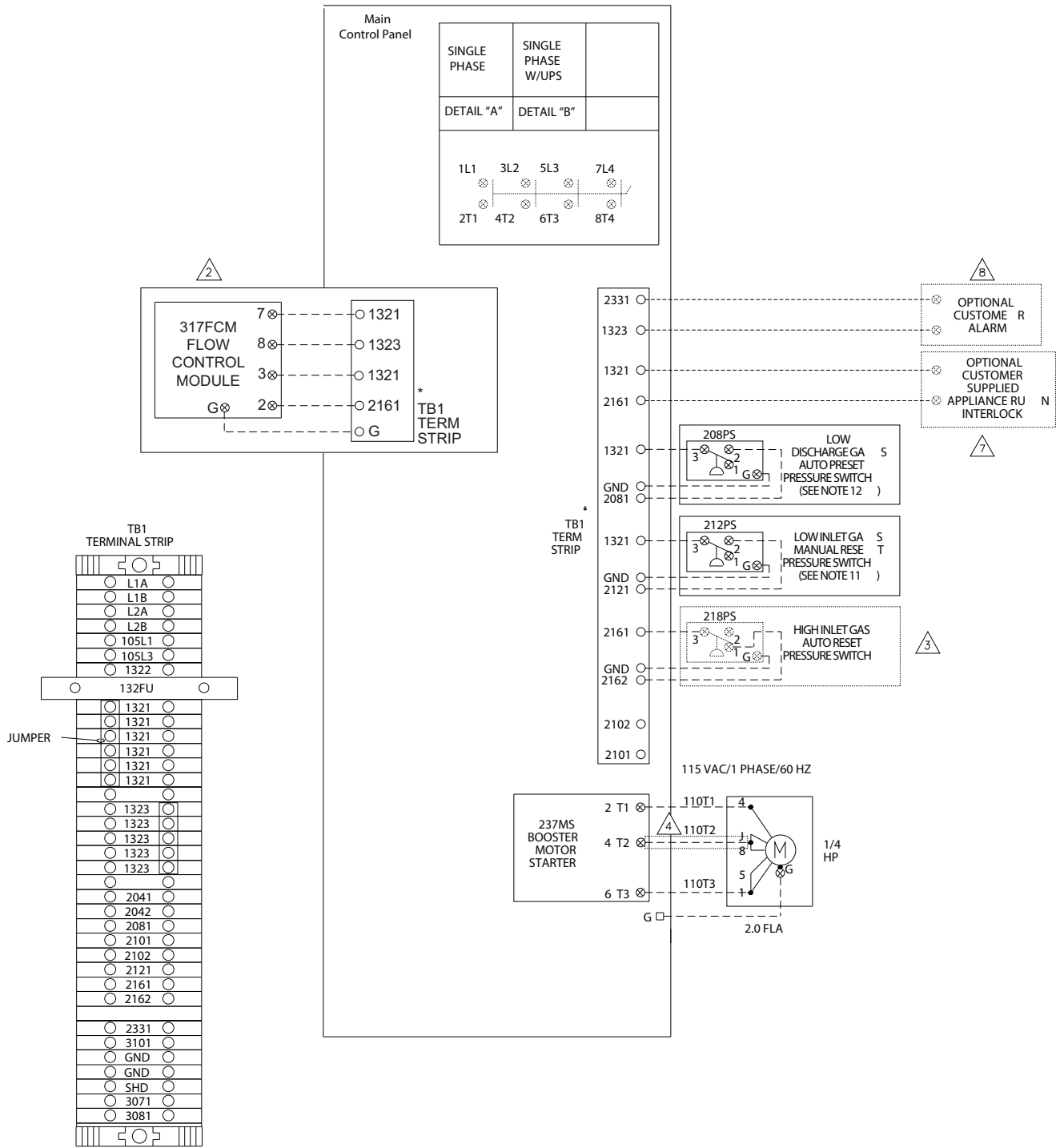

# BoostPak Model LS Wiring Diagram, Continued

**DETAIL "A"**  
SINGLE PHASE INCOMING POWER WITHOUT UPS OPTION

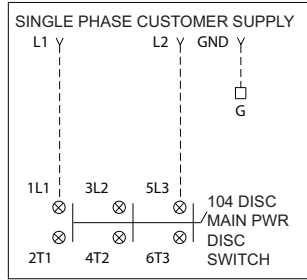

**DETAIL "B"**  
SINGLE PHASE INCOMING POWER WITH THE UPS OPTION

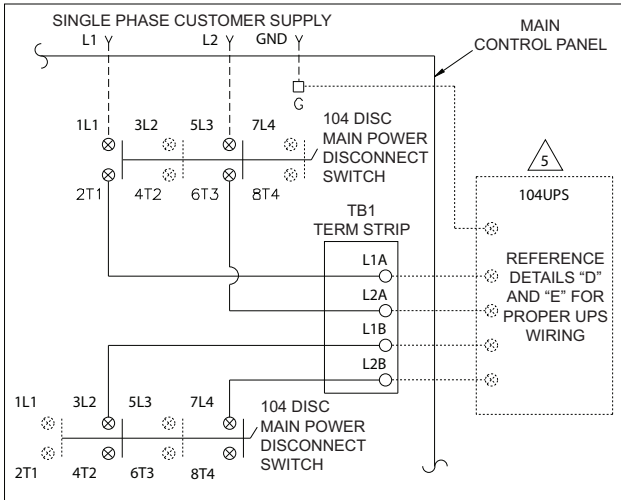

5

**DETAIL "D"**  
USED WHEN THE BOOSTPAK UNIT IS MOUNTED INSIDE AND THE BOOSTER MOTOR IS 1/4 HP (LS MODELS)

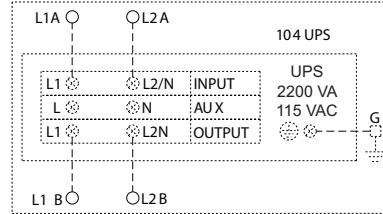

**DETAIL "E"**  
USED WHEN THE BOOSTPAK UNIT IS MOUNTED IN AN OUTDOOR LOCATION AND THE BOOST MOTOR IS 1/4 HP (LS MODELS)

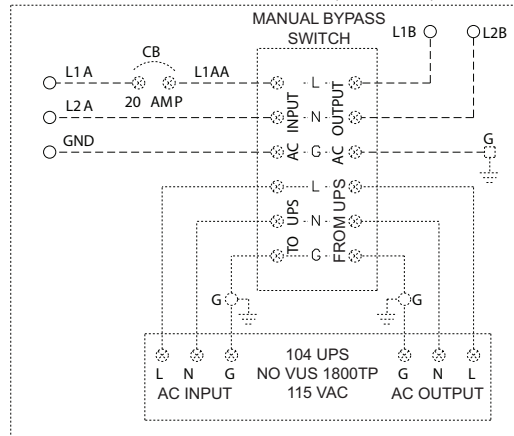

**NOTES**

- 2 Phantom components marked 2 are installed on BoostPak models with the flow control option. The flow control contact is set to close when gas fired equipment causes flow.
- 3 Phantom components marked 3 are installed on BoostPak models with the high inlet gas pressure switch option. Set to value above which the downstream appliance can operate. Auto reset.
- 5 Phantom components marked 5 are installed on BoostPak models with the UPS option.

- 7 Phantom component marked 7 is installed on BoostPak models using the customer supplied appliance run interlock dry contact.
- 8 Phantom component marked 8 is the optional customer alarm. Maximum current is 2 amps.
- 10 All field wiring must conform to local electrical codes.
- 11 Set at 3" w.c. or value by local utility company breaks on pressure drop, manual reset.

- 12 Set @ 3" w.c. below rated boost pressure but not less than 2" w.c. Breaks on pressure drop, auto reset.

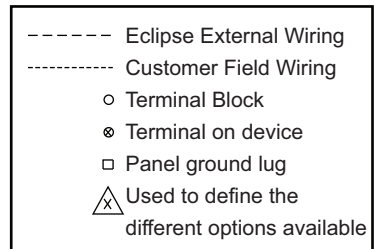

## BoostPak Model LS Mechanical Drawing

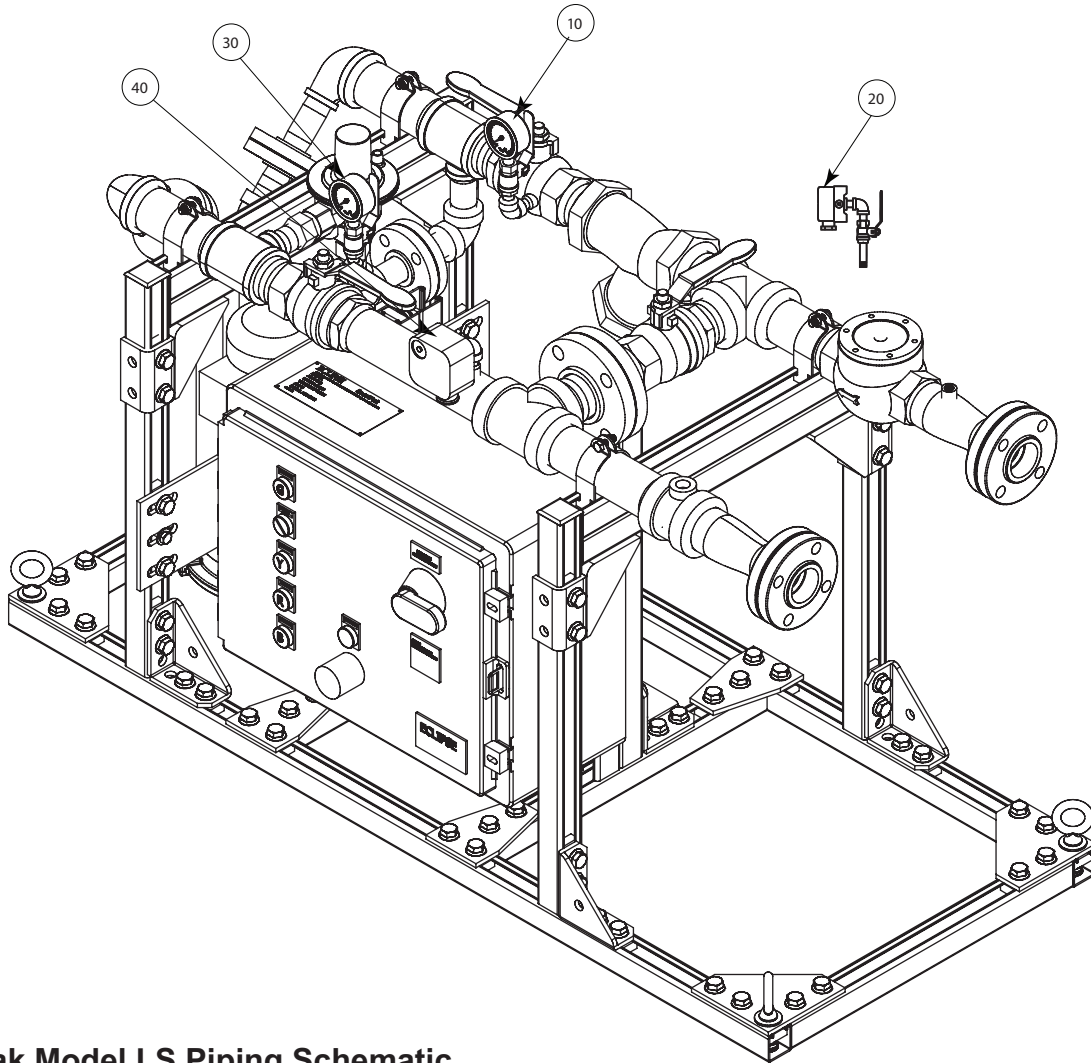

## BoostPak Model LS Piping Schematic

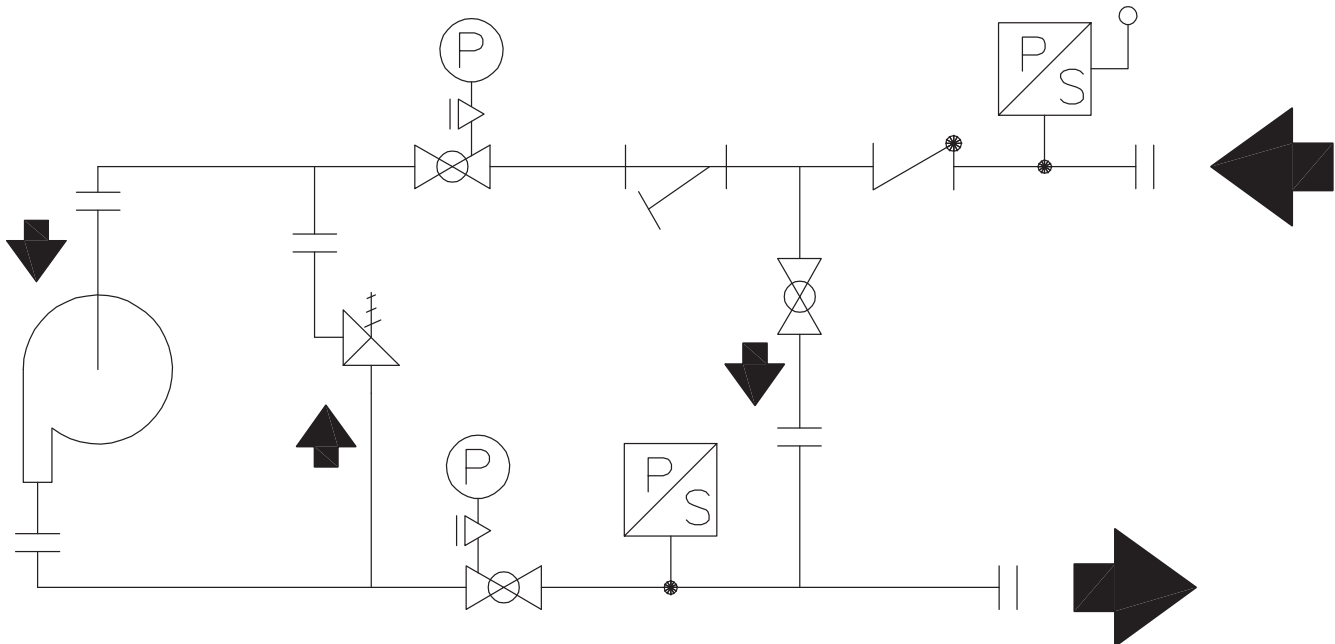



## BoostPak Model LS Panel Layout

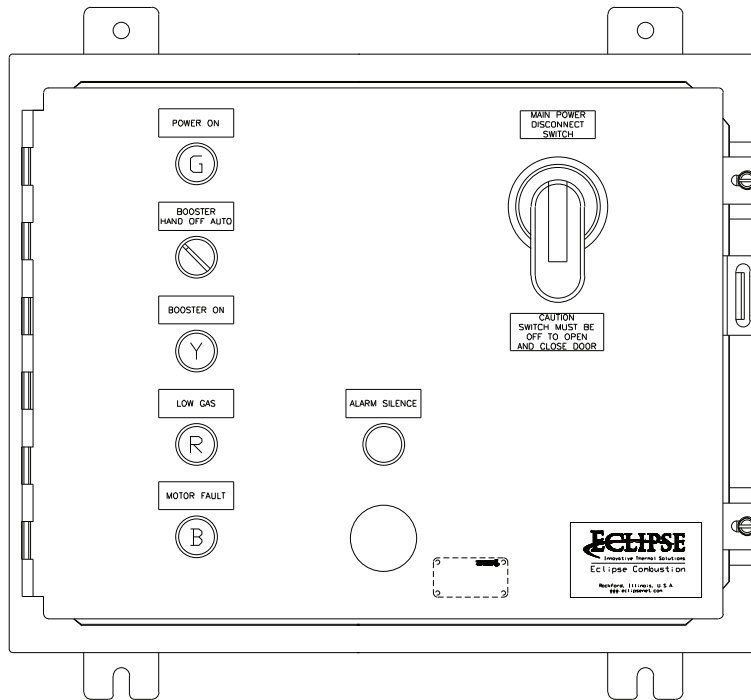

Enclosure 16"H x 20"W x 8"D

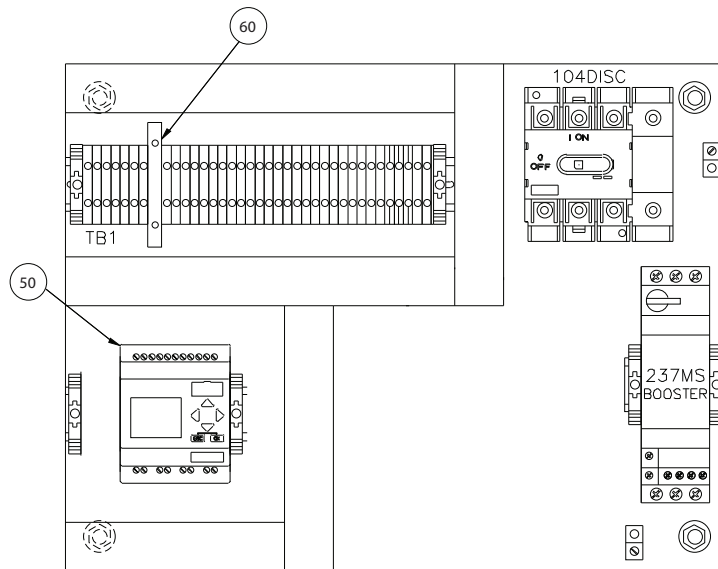

Internal View, Panel 13"H x 17"W

| Ref No. | Part No. | Description                                      |
|---------|----------|--------------------------------------------------|
| 10      | 14655    | Inlet Pressure Gauge 0 - 15" w.c. range          |
| 20      | 14955    | Inlet Pressure Switch, Manual reset 1 - 20" w.c. |
| 30      | 14658    | Outlet Pressure Gauge 0 - 35" w.c. range         |
| 40      | 14598    | Outlet Pressure Switch, Auto Reset 2 - 20" w.c.  |
| 50      | 10025036 | PLC, Program Installed                           |
| 60      | 10013758 | Fuse, 5 amp                                      |



# Appendix

## Conversion Factors

### Metric to English

| From                                      | To                             | Multiply By             |
|-------------------------------------------|--------------------------------|-------------------------|
| actual cubic meter/h (am <sup>3</sup> /h) | actual cubic foot/h (acfh)     | 35.31                   |
| normal cubic meter/h (Nm <sup>3</sup> /h) | standard cubic foot /h (scfh)  | 38.04                   |
| degrees Celsius (°C)                      | degrees Fahrenheit (°F)        | (°C x 9/5) + 32         |
| kilogram (kg)                             | pound (lb)                     | 2.205                   |
| kilowatt (kW)                             | Btu/h                          | 3415                    |
| meter (m)                                 | foot (ft)                      | 3.281                   |
| millibar (mbar)                           | inches water column ("w.c.)    | 0.402                   |
| millibar (mbar)                           | pounds/sq in (psi)             | 14.5 x 10 <sup>-3</sup> |
| millimeter (mm)                           | inch (in)                      | 3.94 x 10 <sup>-2</sup> |
| MJ/Nm <sup>3</sup>                        | Btu/ft <sup>3</sup> (standard) | 26.86                   |

### Metric to Metric







| From              | To                | Multiply By |
|-------------------|-------------------|-------------|
| kiloPascals (kPa) | millibar (mbar)   | 10          |
| meter (m)         | millimeter (mm)   | 1000        |
| millibar (mbar)   | kiloPascals (kPa) | 0.1         |
| millimeter (mm)   | meter (m)         | 0.001       |



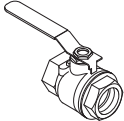
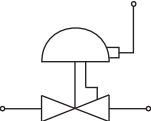
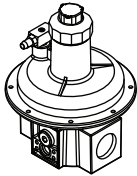
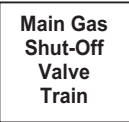

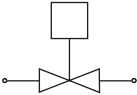
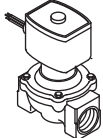

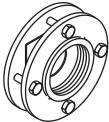

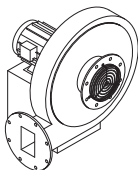

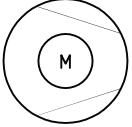
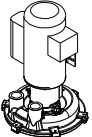
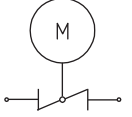
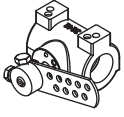
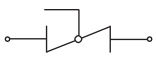
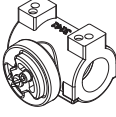
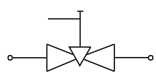

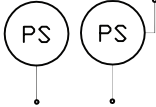

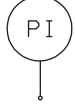
### English to Metric

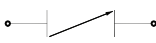
| From                           | To                                        | Multiply By              |
|--------------------------------|-------------------------------------------|--------------------------|
| actual cubic foot/h (acfh)     | actual cubic meter/h (am <sup>3</sup> /h) | 2.832 x 10 <sup>-2</sup> |
| standard cubic foot /h (scfh)  | normal cubic meter/h (Nm <sup>3</sup> /h) | 2.629 x 10 <sup>-2</sup> |
| degrees Fahrenheit (°F)        | degrees Celsius (°C)                      | (°F - 32) x 5/9          |
| pound (lb)                     | kilogram (kg)                             | 0.454                    |
| Btu/h                          | kilowatt (kW)                             | 0.293 x 10 <sup>-3</sup> |
| foot (ft)                      | meter (m)                                 | 0.3048                   |
| inches water column ("w.c.)    | millibar (mbar)                           | 2.489                    |
| pounds/sq in (psi)             | millibar (mbar)                           | 68.95                    |
| inch (in)                      | millimeter (mm)                           | 25.4                     |
| Btu/ft <sup>3</sup> (standard) | MJ/Nm <sup>3</sup>                        | 37.2 x 10 <sup>-3</sup>  |

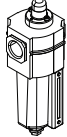

# System Schematics

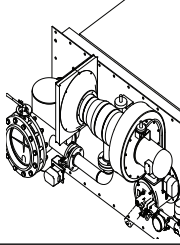
| Symbol                                                                              | Appearance                                                                          | Name                          | Remarks                                                                                                                                                                                                                                                                                                                                        | Bulletin/<br>Info Guide |
|-------------------------------------------------------------------------------------|-------------------------------------------------------------------------------------|-------------------------------|------------------------------------------------------------------------------------------------------------------------------------------------------------------------------------------------------------------------------------------------------------------------------------------------------------------------------------------------|-------------------------|
|    |    | Gas Cock                      | Gas cocks are used to manually shut off the gas supply.                                                                                                                                                                                                                                                                                        | 710                     |
|    |    | Ratio Regulator               | A ratio regulator is used to control the air/gas ratio. The ratio regulator is a sealed unit that adjusts the gas pressure in ratio with the air pressure. To do this, it measures the air pressure with a pressure sensing line, the impulse line. This impulse line is connected between the top of the ratio regulator and the burner body. | 742                     |
|   |                                                                                     | Main Gas Shut-Off Valve Train | Eclipse strongly endorses NFPA as a minimum.                                                                                                                                                                                                                                                                                                   | 790/791                 |
|  |                                                                                     | Pilot Gas Valve Train         | Eclipse strongly endorses NFPA as a minimum.                                                                                                                                                                                                                                                                                                   | 790/791                 |
|  |  | Automatic Shut-Off Valve      | Shut-off valves are used to automatically shut off the gas supply on a gas system or a burner.                                                                                                                                                                                                                                                 | 760                     |
|  |  | Orifice Meter                 | Orifice meters are used to measure flow.                                                                                                                                                                                                                                                                                                       | 930                     |
|  |  | Combustion Air Blower         | The combustion air blower provides the combustion air to the burner(s).                                                                                                                                                                                                                                                                        | 610                     |

| Symbol                                                                              | Appearance                                                                          | Name                        | Remarks                                                                                                                                                             | Bulletin/<br>Info Guide |
|-------------------------------------------------------------------------------------|-------------------------------------------------------------------------------------|-----------------------------|---------------------------------------------------------------------------------------------------------------------------------------------------------------------|-------------------------|
|    |    | Hermetic Booster            | Booster is used to increase gas pressure.                                                                                                                           | 620                     |
|    |    | Automatic Butterfly Valve   | Automatic butterfly valves are typically used to set the output of the system.                                                                                      | 720                     |
|    |    | Manual Butterfly Valve      | Manual butterfly valves are used to balance the air or gas flow at each burner.                                                                                     | 720                     |
|    |    | Adjustable Limiting Orifice | Adjustable limiting orifices are used for fine adjustment of gas flow.                                                                                              | 728/730                 |
|    |    | Pressure Switch             | A switch activated by rise or fall in pressure. A manual reset version requires pushing a button to transfer the contacts when the pressure set point is satisfied. | 840                     |
|   |   | Pressure Gauge              | A device to indicate pressure.                                                                                                                                      | 940                     |
|  |  | Check Valve                 | A check valve permits flow only in one direction and is used to prevent back flow of gas.                                                                           | 780                     |
|  |  | Strainer                    | A strainer traps sediment to prevent blockage of sensitive components downstream.                                                                                   |                         |
|  |  | Flexible Connector          | Flexible connectors isolate components from vibration, mechanical, and thermal stresses.                                                                            |                         |
|   |  | Heat Exchanger              | Heat exchangers transfer heat from one medium to another.                                                                                                           | 500                     |
|  |                                                                                     | Pressure Taps               | Pressure taps measure static pressure.                                                                                                                              |                         |

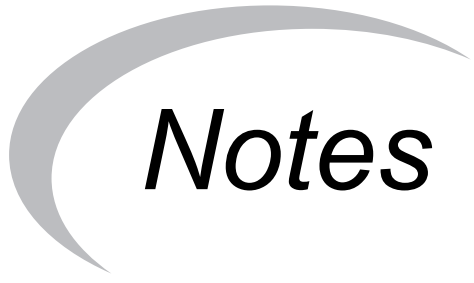

# *Notes*

