

## VS

Solenoid valve for gas  
Vannes magnétiques pour gaz  
Válvulas magnéticas para gas

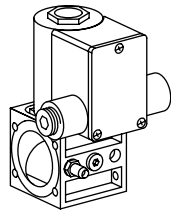

VS 1

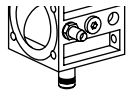

VS 1..D

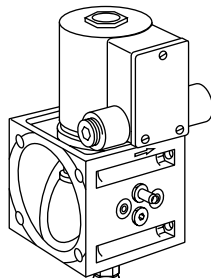

VS 2

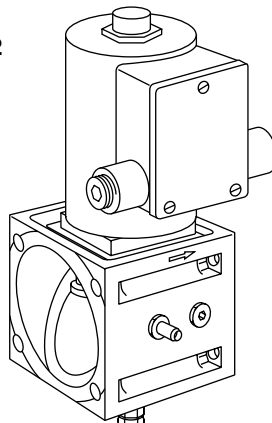

VS 3

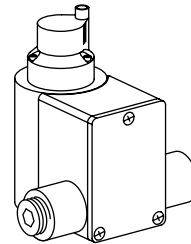

VS..L

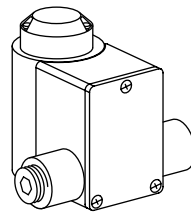

VS 2..D  
VS 3..D

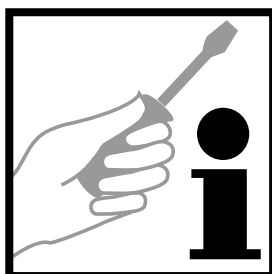

Operating instructions  
Instructions de service  
Instrucciones de utilización



### WARNING!

Improper installation, adjustment, modification, operation or maintenance could lead to injury or damage. All adjustments must be made by a qualified technician.  
Wiring must comply with local codes and the National Electrical Codes (for Canada CSA C22.1 Canadian Electrical Code). To prevent the possibility of property damage turn off electrical power, depressurize solenoid operator and/or valve, vent fluid to a safe area before servicing.

### ATTENTION !

Un montage non conforme, des réglages, une modification, une utilisation et un entretien non conformes peuvent entraîner des risques de blessures ou des dommages matériels. Tous les réglages doivent être exécutés par un technicien qualifié.  
Le câblage doit respecter les réglementations locales et les réglementations de la compagnie d'électricité nationale (pour le Canada CSA C22.1 Réglementations de la compagnie d'électricité du Canada). Pour éviter le risque de dommage matériel, couper l'alimentation électrique, mettre hors pression l'opérateur électromagnétique et/ou la vanne, vider le fluide sur une zone sans risque avant l'entretien.

### ¡ATENCIÓN!

El montaje, ajuste, modificación, manejo o mantenimiento incorrecto puede ocasionar daños personales o materiales. Todos los ajustes deben ser hechos por personal especializado.  
Este aparato debe ser instalado observando las normativas locales y las normativas de la Sociedad Nacional de Electricidad (para el Canadá CSA C22.1 Normativas de la Sociedad de Electricidad del Canadá). Para evitar daños y accidentes desconectar la alimentación eléctrica, descomprimir el solenoide y/o la válvula y ventilar el área de seguridad antes de comenzar con las tareas.

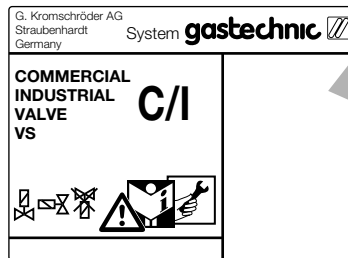

Red = open  
White = closed  
Rouge = ouvert  
Blanc = fermé  
Rojo = abierto  
Blanco = cerrado

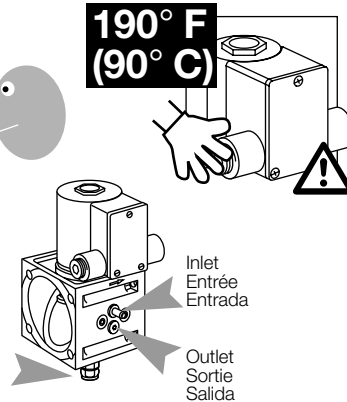

#### Technical data

VS valves are Commercial/Industrial (C/I) valves (ANSI 21.21, CGA 6.5-M95)  
Type of gas: natural gas, LPG, air  
Max. inlet pressure: VS..02: 2 psig (140 mbar) VS..03: 5 psig (360 mbar)  
Mains voltage: 120 V, -15/+10 %, 50/60 Hz  
Type of enclosure: NEMA 3, COF. CSA ENC 4  
Ambient temperature: -4 to 104°F (-20 to +40°C)  
CSA approved up to 140°F (60°C)

#### Données techniques

Les vannes VS sont des vannes magnétiques commerciales/ industrielles (C/I) (ANSI 21.21, CGA 6.5-M95)  
Type de gaz : gas naturel, GPL, air  
Pression d'entrée max. : VS..02: 2 psig (140 mbar) VS..03: 5 psig (360 mbar)  
Tension réseau : 120 V, -15/+10 %, 50/60 Hz  
Type de boîtier : NEMA 3, COF. CSA ENC 4  
Température ambiante : -4 à 104°F (-20 à +40°C)  
Agréée CSA jusqu'à 140°F (60°C)

#### Datos técnicos

Las válvulas VS son válvulas comerciales/ industriales (C/I) (ANSI 21.21, CGA 6.5-M95)  
Tipo de gas: gas natural, GLP, aire  
Máx. presión de entrada: VS..02: 2 psig (140 mbar) VS..03: 5 psig (360 mbar)  
Voltaje de alimentación: 120 V, -15/+10 %, 50/60 Hz  
Tipo de envolvente: NEMA 3, COF. CSA ENC 4  
Temperatura ambiente: -4 a 104°F (-20 a +40°C)  
CSA aprobado hasta 140°F (60°C)

Type/Tipo	Current			Weight/Poids/Peso	
	norm [A]	min [A]	max [A]	LBS	kg
VS 115ML..M9	0.13	0.11	0.15	3.1	1.4
VS 125ML..M9	0.14	0.13	0.16	3.7	1.7
VS 232ML..M9I	0.18	0.16	0.21	6.2	2.8
VS 240ML02..M9I	0.31	0.27	0.36	0.8	4.9
VS 240ML03..M9I	0.36	0.30	0.42	11.7	5.3
VS 350ML02..M9I	0.36	0.30	0.42	17.0	7.7
VS 350ML03..M9I	0.37	0.31	0.42	17.0	7.7

## Installation

## Montage

## Instalación

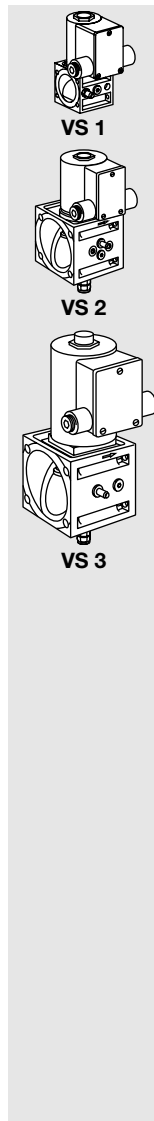

Fitting position

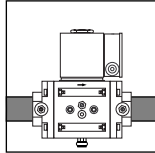

Position de montage

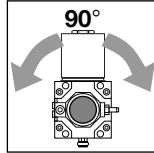

Posición de montaje

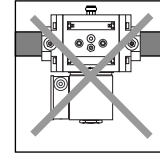
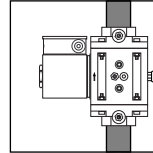

>3/4" (20 mm)

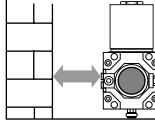

Seal in pipework.  
Note direction of flow.  
Screw pipework into flange.  
Insert O-ring.  
Assemble; provide filter.  
Do not use coil as lever.

Réaliser l'étanchéité des conduites.  
Veiller au sens d'écoulement.  
Visser la conduite dans la bride.  
Poser le joint.  
Assembler, prévoir le filtre.  
Ne pas utiliser la bobine comme levier.

Hermetizar la tubería.  
Observar el sentido de flujo.  
Enrosacar la tubería en la abrazadera.  
Insertar el anillo obturador.  
Efectuar el montaje; prever un filtro.  
No utilizar el cuerpo magnético como palanca.

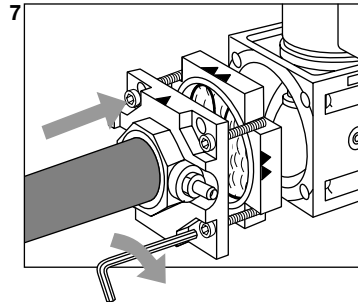
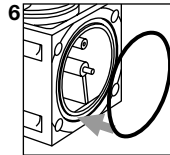
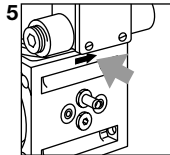
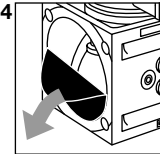
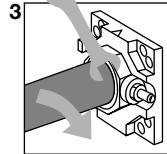
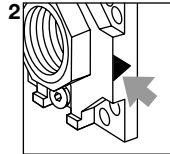
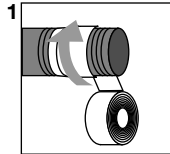

## Wiring

## Câblage

## Cableado

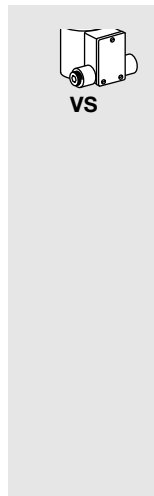

Disconnect from power supply.  
Shut off gas supply.  
See label for supplied voltage.

Couper l'alimentation électrique.  
Couper l'arrivée de gaz.  
Vérifier la tension admissible sur la plaquette signalétique.

Desconectar de la alimentación eléctrica.  
Cerrar el suministro de gas.  
Véase la etiqueta en relación a la tensión de suministro.

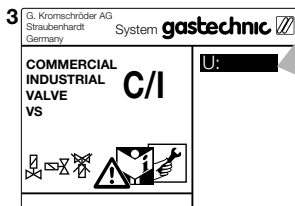
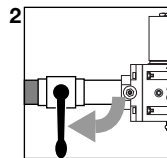
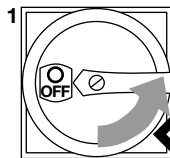

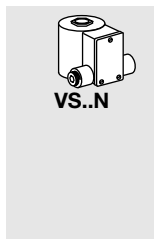

Loosen nut.  
Turn coil.  
Re-tighten nut.

Desserrer l'écrou.  
Tourner la bobine.  
Resserrer l'écrou.

Aflojar la tuerca.  
Girar el cuerpo magnético.  
Volver a apretar la tuerca.

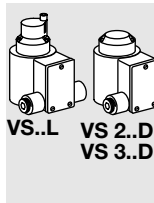
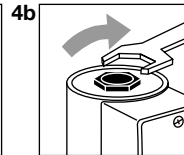
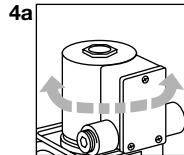
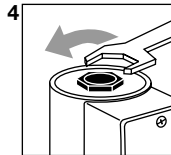

Rotate coil to desired position.

Tourner la bobine à la position désirée.

Girar el cuerpo magnético a la posición deseada.

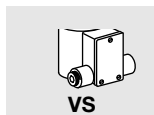
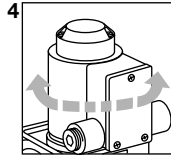

Use supply wires suitable for at least 194°F (90°C).  
Terminals: maximum 14 gauge wire size.  
Remove cover and seal from terminal box.  
Use either left or right access into terminal box.  
Remove thread protector.  
Place 1/2 plug in port not being used.  
Pull conductors through the conduit into the terminal box in accordance with the wiring diagram on the terminal strip.  
We recommend connecting an equipment ground to ground terminal.

Employer des fils d'alimentation qui conviennent pour au moins 194°F (90°C).  
Bornes : fil section 14 gauge (2,5 mm<sup>2</sup>) maxi.  
Retirer le couvercle et le joint de la boîte à bornes.  
Utiliser l'accès de gauche ou de droite de la boîte à bornes.  
Retirer le capuchon vissé.  
Placer un bouchon 1/2 dans l'orifice inutilisé.  
Introduire les conducteurs dans la boîte à bornes en les passant dans le conduit, en respectant le plan de câblage de la barrette à bornes.  
Nous recommandons de brancher un équipement de masse à la borne de masse.

Utilizar cables que sean adecuados para una temperatura de por lo menos 90°C (194°F).  
Bornes: alambre sección 14 gauge (2,5 mm<sup>2</sup>) máximo.  
Retirar la tapa y la junta de la caja de bornes.  
Utilizar cualquiera de los accesos, de derecha o de izquierda, hacia el interior de la caja de bornes.  
Quitar totalmente el protector.  
Atornillar un prensaestopas de 1/2 en una entrada libre.  
Llevar los hilos por el canal de cables hasta la caja de conexiones de acuerdo con el circuito de cableado de la bornera.  
Recomendamos conectar el conductor de protección.

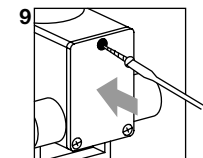
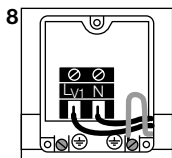
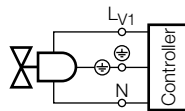
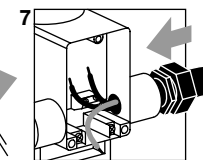
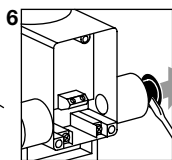
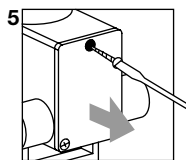

## Pressure testing

## Contrôle d'étanchéité

## Prueba de estanqueidad

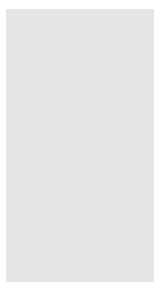

Disconnect from power supply.  
Apply pressure to inlet of the valve.  
Soap pipe joints at the inlet and check for bubbles.  
Open the valve.  
Apply pressure to outlet of the valve.  
Soap pipe joints at the outlet and check for bubbles.

Couper l'alimentation électrique.  
Mettre l'entrée de la vanne sous pression.  
Enduire les joints du raccord d'entrée d'eau savonneuse et vérifier qu'il n'y a pas de bulles.  
Ouvrir la vanne.  
Enduire les joints du raccord de sortie d'eau savonneuse et vérifier qu'il n'y a pas de bulles.

Desconectar de la alimentación eléctrica.  
Aplicar presión a la entrada de la válvula.  
Aplicar jabón a las juntas de los conductos de entrada y comprobar la existencia de burbujas.  
Abrir la válvula.  
Aplicar presión a la salida de la válvula.  
Aplicar jabón a las juntas de los conductos de salida y comprobar la existencia de burbujas.

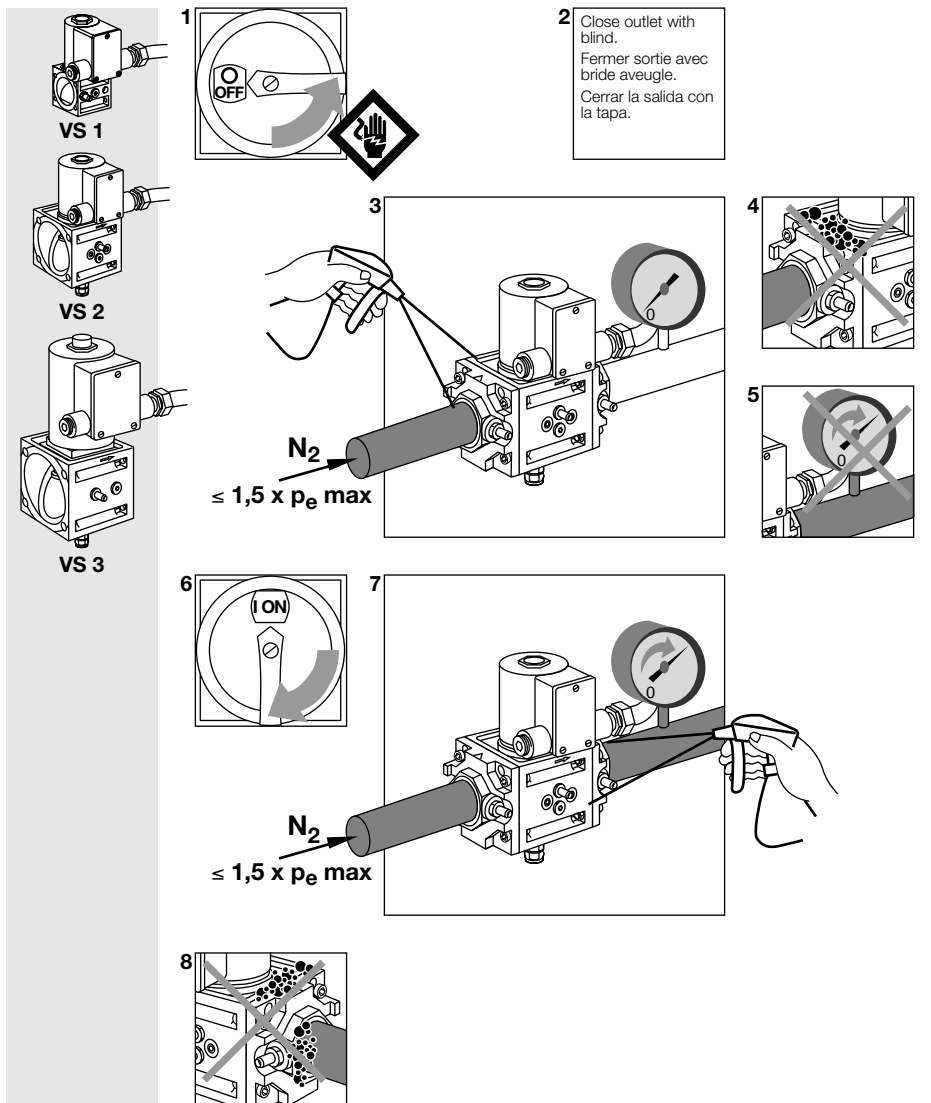

**Adjustment of gas flow**

**Réglage du gaz de démarrage**

**Ajuste del caudal inicial de gas**

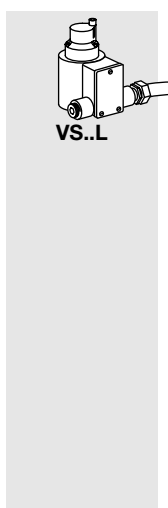

From fully damped to undamped fast stroke. Fully damped when delivered. Loosen slotted head screw, do not remove entirely! Do not turn the varnished retaining screw! Turn the damping element until the desired initial gas flow has been attained. Re-tighten slotted head screw.

D'amortissement maximum à course rapide non amortie. Amortissement maximum à la livraison. Desserrer la vis à tête fendue : ne pas la dévisser entièrement ! Ne pas tourner la vis de protection laquée ! Tourner le corps de l'amortisseur jusqu'à avoir atteint le débit initial de gaz voulu. Resserrer la vis à tête fendue.

De un desplazamiento amortiguado hasta uno sin amortiguación. En modelos suministrados con amortiguación. ¡Alojar el tornillo de ranura sin quitarlo totalmente! ¡No girar el tornillo asegurado con pintura! Girar el cuerpo de amortiguación hasta alcanzar el volumen de gas de arranque deseado. Apretar nuevamente el tornillo ranurado.

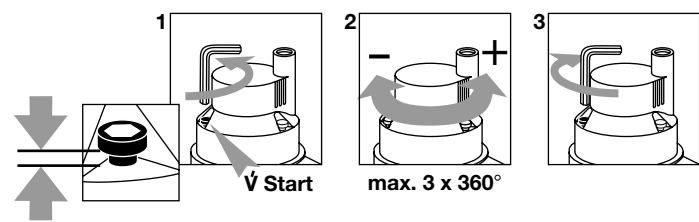

## Adjust max. gas flow

## Régler le débit

## Ajuste del caudal



Flow can be adjusted from 4–100% of rating.

Le débit peut être réglé entre 4–100 % du nominal.

El flujo se puede ajustar del 4–100% del rango.

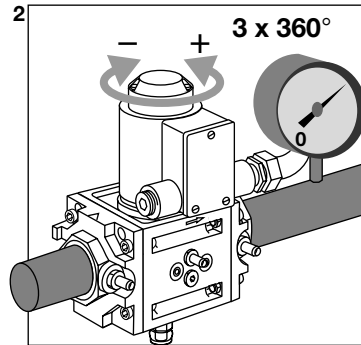
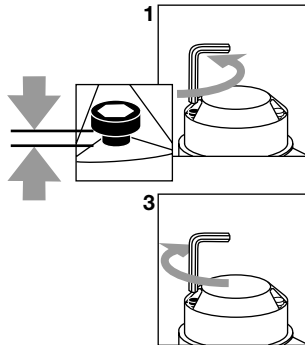
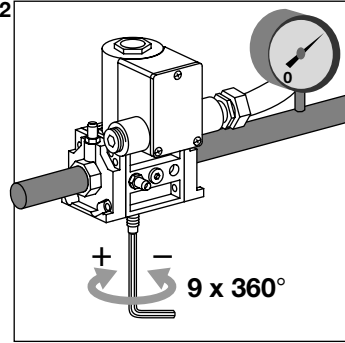
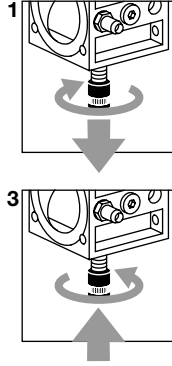

## Replacing the rectifier board

## Remplacement de la platine du redresseur

## Sustitución de la placa del circuito rectificador

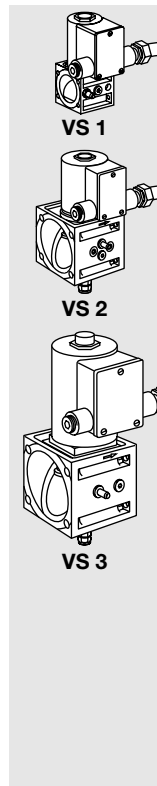

Disconnect from power supply.  
Shut off gas supply.  
Disconnect the 120 V leads LV1/N at terminals.  
Disconnect the coil leads from terminal strip.  
Remove retaining nut and remove rectifier board.

Couper l'alimentation électrique.  
Couper l'alimentation en gaz.  
Débrancher les conducteurs de 120 V LV1/N aux bornes.  
Débrancher les conducteurs de bobine de la barrette à bornes.  
Enlever l'écrou de fixation et enlever la platine du redresseur.

Desconectar de la alimentación eléctrica.  
Cerrar el suministro de gas.  
Abrir la conducción de 120 V LV1/N de las borneras.  
Interrumpir la alimentación a la la bobina de la bornera.  
Quitar la tuerca de sujeción y cambiar la platina rectificadora.

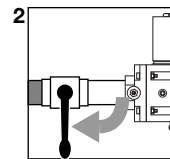
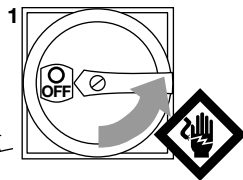

3 CAUTION: Label all wires prior to disconnection when servicing valves. Wiring errors can cause improper and dangerous operation.  
ATTENTION. Au moment de l'entretien des commandes, étiquetez tous les fils avant le débranchement. Des erreurs de câblage peuvent nuire au bon fonctionnement.  
PRECAUCION: Etiquetar todos los cables con anterioridad a su desconexión a la hora de realizar el servicio de la válvula. Los errores de cableado pueden provocar un funcionamiento inadecuado y peligroso.

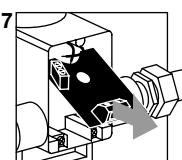
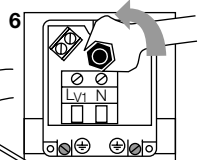
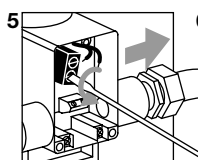
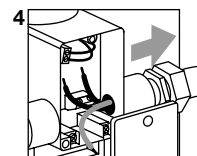

8 Reassemble in reverse order.  
Remontage : opérer dans l'ordre inverse.  
Volver a montar en sentido contrario.

## Maintenance

## Maintenance

## Mantenimiento

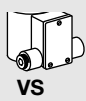

VS

Annually.  
Disconnect from power supply.  
Shut off gas supply.

1 fois par an  
Couper l'alimentation électrique.  
Couper l'alimentation en gaz.

Anualmente:  
Desconectar de la alimentación eléctrica.  
Cerrar el suministro de gas.

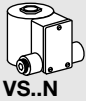
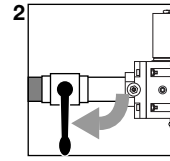
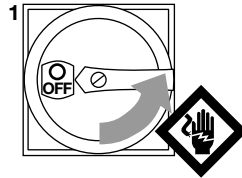
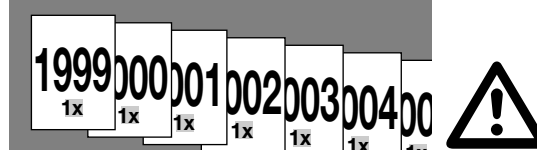

VS..N

Remove nut.

Dévisser l'écrou.

Retirar la tuerca.

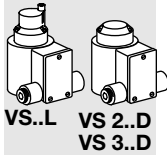
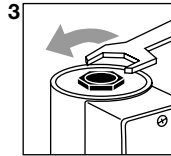

VS..L

VS 2..D

VS 3..D

Remove three screws, two of them varnished.  
Remove the damping housing or flow adjuster.  
Press clamping plate out to right.  
Remove spring washer.

Dévisser trois vis, dont deux sont laquées.  
Retirer le boîtier de l'amortisseur ou régulateur de débit.  
Ejecter la plaquette de blocage vers la droite.  
Enlever la rondelle élastique.

Retirar los tres tornillos, dos de ellos asegurados con barniz.  
Retirar el alojamiento del amortiguador o el regulador de flujo.  
Empujar la placa de fijación hacia afuera a la derecha.  
Retirar la arandela del muelle.

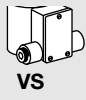
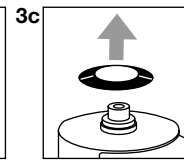
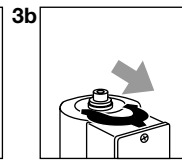
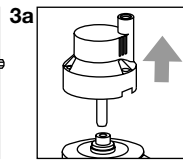
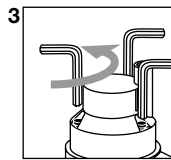

VS

Disconnect 120 V supply at junction box.  
Remove coil.  
Remove four screws.  
Remove coil support.  
Remove core with spindle and disk, clean with a dry cloth.

Débrancher l'alimentation 120 V à la boîte à bornes.  
Enlever la bobine.  
Dévisser quatre vis.  
Enlever le support de bobine.  
Retirer l'armature avec la tige et le clapet, les nettoyer avec un chiffon sec.

Desconectar el suministro de 120 V en la caja de conexiones.  
Retirar el cuerpo magnético.  
Retirar los cuatro tornillos.  
Retirar las conexiones de las bobinas.  
Retirar el núcleo con el eje y el disco, limpiar con un paño seco.

4 CAUTION: Label all wires prior to disconnection when servicing valves. Wiring errors can cause improper and dangerous operation.  
ATTENTION. Au moment de l'entretien des commandes, étiquetez tous les fils avant le débranchement. Des erreurs de câblage peuvent nuire au bon fonctionnement.  
PRECAUCION: Etiquetar todos los cables con anterioridad a su desconexión a la hora de realizar el servicio de la válvula. Los errores de cableado pueden provocar un funcionamiento inadecuado y peligroso.

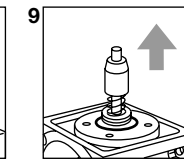
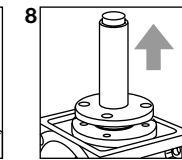
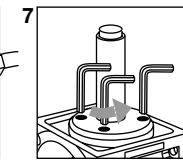
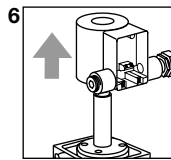
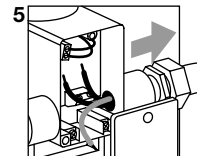



VS

Check tightness of O-rings. Replace if they are worn, hardened or swollen.  
 Check spring for corrosion, if necessary replace core.  
 Assemble in reverse order.  
 Attention: The spindle of the damping element can not be pressed in by hand.  
 Check tightness after resealing (apply gas pressure to the valve).  
 Check housing cover or housing surface for leaks before restarting system.  
 Verify proper operation after servicing.

Vérifier l'étanchéité des bagues toriques. Les changer si elles sont usées, durcies ou gonflées.  
 Vérifier que le ressort n'est pas corrodé, remplacer éventuellement l'armature.  
 Le remontage s'effectue en opérant dans l'ordre inverse.  
 Attention : la tige de l'amortisseur ne peut être engagée à la main.  
 Vérifier l'étanchéité après le remasticage (il faut brancher la pression de gaz sur la vanne).  
 Vérifier les fuites du couvercle du boîtier ou de la surface extérieure du boîtier avant de remettre l'installation en marche.  
 S'assurer que l'appareil fonctionne adéquatement une fois l'entretien terminé.

Comprobar la estanqueidad de los anillos tóricos.  
 Sustituir si se encuentran desgastados, si se han endurecido o inflado.  
 Comprobar la existencia de corrosión en el muelle, si fuera necesario sustituir el núcleo.  
 Volver a montar en orden inverso.  
 Atención: El eje del elemento amortiguador no puede ser presionado a mano.  
 Comprobar la estanqueidad después de haber vuelto a cerrar (debe existir presión de gas a la válvula).  
 Comprobar las posibles fugas en la tapa o en la superficie del alojamiento antes de volver a poner en marcha el sistema.  
 Verificar el funcionamiento correcto después del servicio.

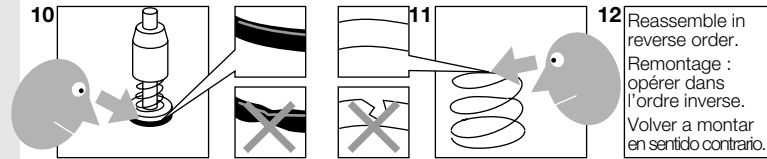

12 Reassemble in reverse order.  
 Remontage : opérer dans l'ordre inverse.  
 Volver a montar en sentido contrario.

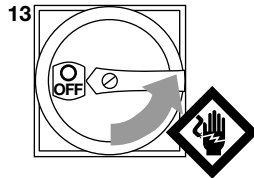

14 Close outlet with blind.  
 Fermer sortie avec bride aveugle.  
 Cerrar la salida con la tapa.

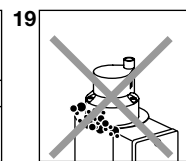
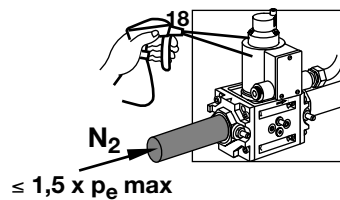
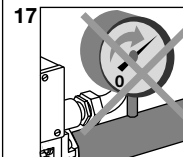
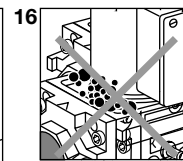
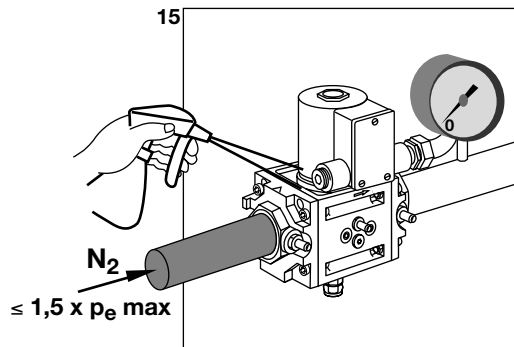



Spare parts

Pièces détachées

Requestos

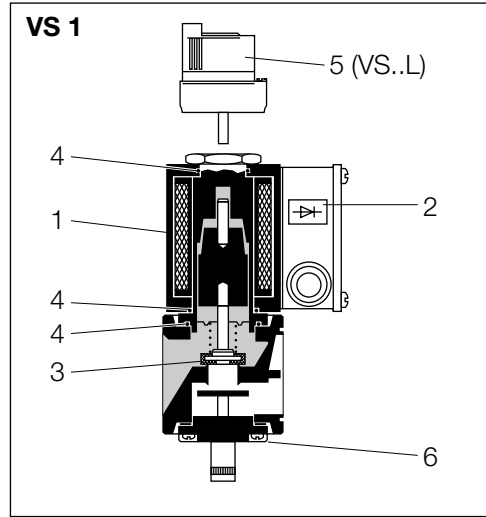

**VS 115ML02..**

1	23190054
2	23195054
3	53101400
4	23190090
5	23190060
6	23190070

**VS 115ML03..**

1	23190054
2	23195054
3	53101400
4	23190090
5	23190060
6	23190070

**VS 125ML02..**

1	23191054
2	23195054
3	53101420
4	23190090
5	23191060
6	23190070

**VS 125ML03..**

1	23191054
2	23195054
3	-
4	23190090
5	23191060
6	23190070

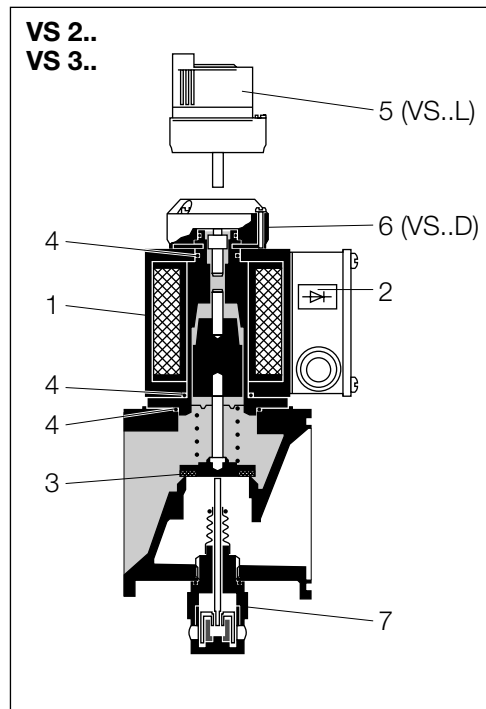

**VS 232ML02..**

1	23192054
2	23195054
3	53101440
4	23192090
5	23192060
6	23190080
7	23101450

**VS 232ML03..**

1	23192054
2	23195054
3	-
4	23192090
5	23192060
6	23190080
7	23101440

**VS 240ML02..**

1	23193054
2	23195054
3	53100010
4	23193090
5	23194060
6	23193080
7	23101460

**VS 240ML03..**

1	23194054
2	23195054
3	53100010
4	23193090
5	23194060
6	23193080
7	23101460

**VS 350ML02..**

1	23194054
2	23195054
3	53100020
4	23194090
5	23194060
6	23193080
7	23101470

**VS 350ML03..**

1	23195224
2	23195054
3	53100020
4	23194090
5	23194060
6	23193080
7	23101470



Kromschroder Inc.  
Hudson, OH 44236  
Phone: 3 30/3 42 05 95  
Fax: 3 30/3 42 05 96  
www.kromschroder.com  
KSINCUSA@AOL.COM

G. Kromschroder AG  
49018 Osnabrück, Germany  
Phone: 05 41/12 14-0  
Fax: 05 41/12 14-3 70  
www.kromschroeder.com  
kromschroeder@t-online.de

