



**EnCal 3000 Quad
Gas Chromatograph
Software Manual**

73022345 b 24.09.2014

Kontaktinformationen / Contact Information	2
Gas quality measurement system EnCal 3000	3
1 Introduction.....	5
1.1 System Requirements	5
1.2 Installation CD	5
1.3 RGC3000 installation.....	6
1.4 WinDCS	11
1.5 History Log	14
1.6 Update MicroGC	19
2 IP Settings PC.....	25
2.1 Configuration with default IP Settings.....	26
2.2 Configuration with customer specific IP Settings.....	31
2.3 Upload of GC Configuration	36
3 Overview of the Main Functions	43
3.1 Introduction	43
3.2 Instrument 'Status'	43
3.3 Start (Control).....	45
3.4 Chromatogram	47
3.5 Upload / Download	50
3.6 Window Instrument Setup (Menu Method).....	51
3.7 Window Integration events (Menu Method).....	53
3.8 Window Peak Identification (Menu Method)	54
3.9 Window Peak Calibration (Menu Method).....	55
3.10 Window Advanced Settings (Menu Method)	56
3.11 Window Method Properties (Menu Method).....	57
3.12 Normalize and Calorific Power (Menu Application).....	58
3.13 Verification Check and Alarms (Menu Application).....	60
3.14 Relays (Menu Application)	61
3.15 Sequence (Menu Automation).....	62
3.16 Modbus Setup (Menu Automation)	63
4 Standard Operations	64
4.1 Introduction	64
4.2 Sample gas order (Sequence)	64
4.3 Calibration	68
4.4 Setting the retention times (Peaks)	74
4.5 Verification.....	75
4.6 Setting the limits for alarms (Alarms)	77
4.7 Configuration of ModBus Table (Modbus Setup)	78
4.8 Generation of reports (Report).....	82
5 Quick Start-up	85
5.1 Introduction	85
5.2 Build a connection	85
5.3 Instrument Status.....	86
5.4 Calibration settings	87
5.5 Sequence settings (ordering).....	89
5.6 Report settings.....	90
5.7 Continuous Analysis.....	91

Kontaktinformationen / Contact Information

Hersteller / Manufacturer:

Elster GmbH
Steinern Straße 19-21
55252 Mainz-Kastel
Deutschland / Germany
Tel. ++49 (0) 61 34 / 605-0
www.elster.com

Kundenbetreuung / Aftersales/ Service Germany & International:

Elster GmbH
Schlossstrasse 95a
44357 Dortmund
Deutschland / Germany
Tel. ++49 (0) 231 93 71 10-88
e-mail: system.Support-DO@elster.com

Internationaler Service / Aftersales /Service International:

Elster-Instromet N.V.
Rijkmakerlaan 9
2910 Essen
Belgien / Belgium
Tel. ++32 (0) 3 6 700 700
e-mail: aftersales@elster-instromet.com?

Vorort Vertretung / Or your local agent:

www.elster-instromet.com

Gas quality measurement system EnCal 3000

The gas quality measurement system EnCal 3000 consists in its basic configuration of a measuring unit and an optional EnCal3000 controller.

The measuring unit of the analysis is conducted by measuring autonomy while using a PC program is parameterized. Optionally, additional computers can be installed (see Figure 1).

The parameterization of the measuring unit is done with the PC program "RGC 3000". This manual is describing this software. The other subsystems are described in 2 separate manuals.

The subsystems communicate with each other via Modbus. It is performed by a computer, the role of the Modbus master that controls the measuring unit (Modbus slave). The other two optional computers behave as so-called listener, i.e. they read the communication with the Modbus and extract the relevant data. The Modbus listeners send and process any commands.

The controller can be used as main display and recording device inside the gas quality measurement system EnCal 3000. Each controller can process one or two gas streams, in which a gas stream can also be assigned to several computers. So that it is possible to, for example, to distribute the data of a gas stream to multiple (DSfG) buses. The measured values are displayed on the display.

In its function as a Modbus master, the controller serves as a tool to operate the process gas chromatograph (e.g. a calibration can be performed). In addition to the main registration function the controller gives additional a number of operating functions.

The parameterization of the controller is done via the PC program "Gas Works". This software and further details of the computers are in a third manual described.

A fourth optional manual is finally for an overview on specific applications of the EnCal 3000.

Basic configuration EnCal 3000 Quad (Measuring unit and an optional Encal3000 controller)

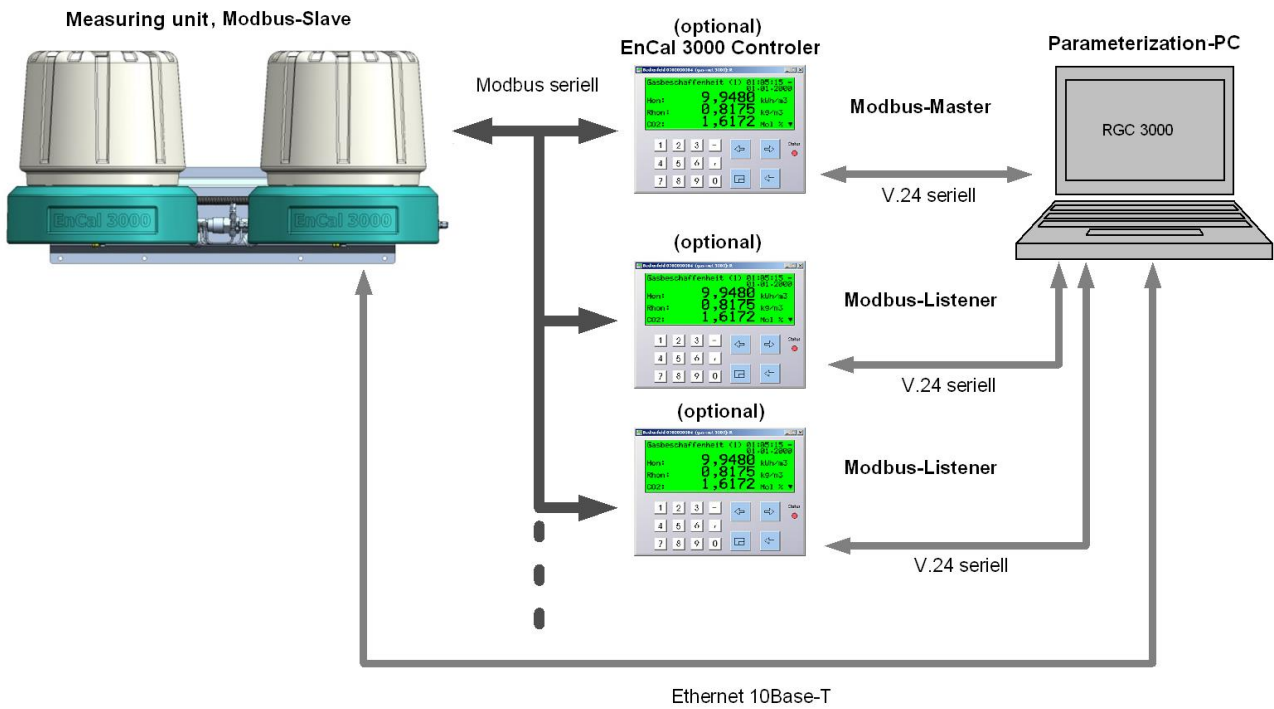

Figure 1

1 Introduction

This chapter describes how to install RGC3000 and other optional and convenient tools. All programs can be found on the Installation CD-ROM, included with the unit.

1.1 System Requirements

Hardware

Processor speed: Processor with 1000MHz Clockspeed or higher
Internal RAM: Recommended 512MB RAM or more.
Peripherals: CD-Rom player
Free Ethernet port
Free USB slot Software:

Software

Windows versions: Windows 2000 or Windows XP professional edition (Service Pack 1 or higher) or Windows 7. *If Windows XP SP2 is installed, the windows firewall must be disabled!*

1.2 Installation CD

Before installation:

Users must log in as a “Windows administrator”.



Make sure no other Windows applications are running during the installation.

Caution: Make a Backup before you change the software installation. Save the existing settings from "Method"; "Application"; "Sequence"; "Site Information" and "Modbus Settings" as described in chapter 3.5!

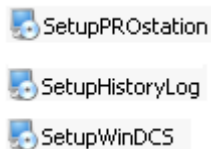
The CD-Rom is auto-starting. If not, double-click on the file “autorun.exe” located in the CD main directory. Following programs are on the CD:

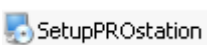

Depending on the chosen menu item it will install:

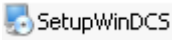
	Configuration, trouble-shooting and generation of reports exclusively designed for the EnCal 3000
	Data log of the last 35 days according API chapter 21.1
	Test and simulation tool for the ModBus communication (serial and TCP/IP) of the EnCal 3000

After choosing a menu item the setup will guide the user through the Installation procedure. See the next chapters for details.

Please note: Versions shown in the pictures of this documentation are not always the same as you will install!

1.3 RGC3000 installation

After choosing the  SetupPROstation item from the setup menu a welcome screen will be visible, this shows the software version and displays some important notes.

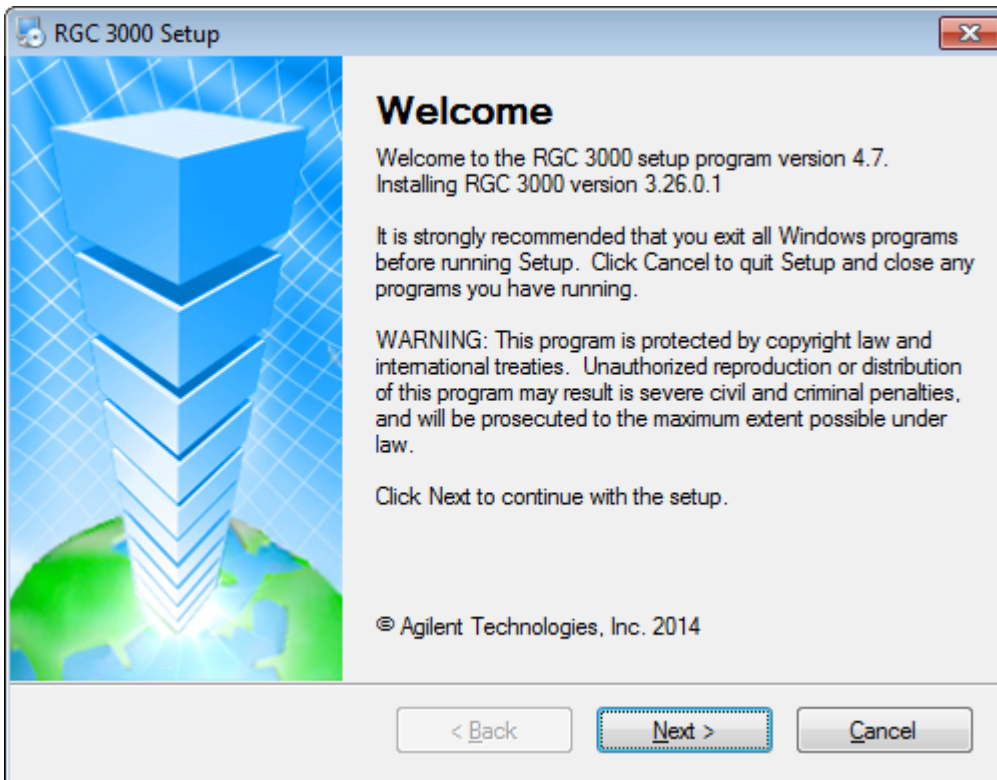

Clicking on “Next” leads to the license Agreement. Read this carefully.

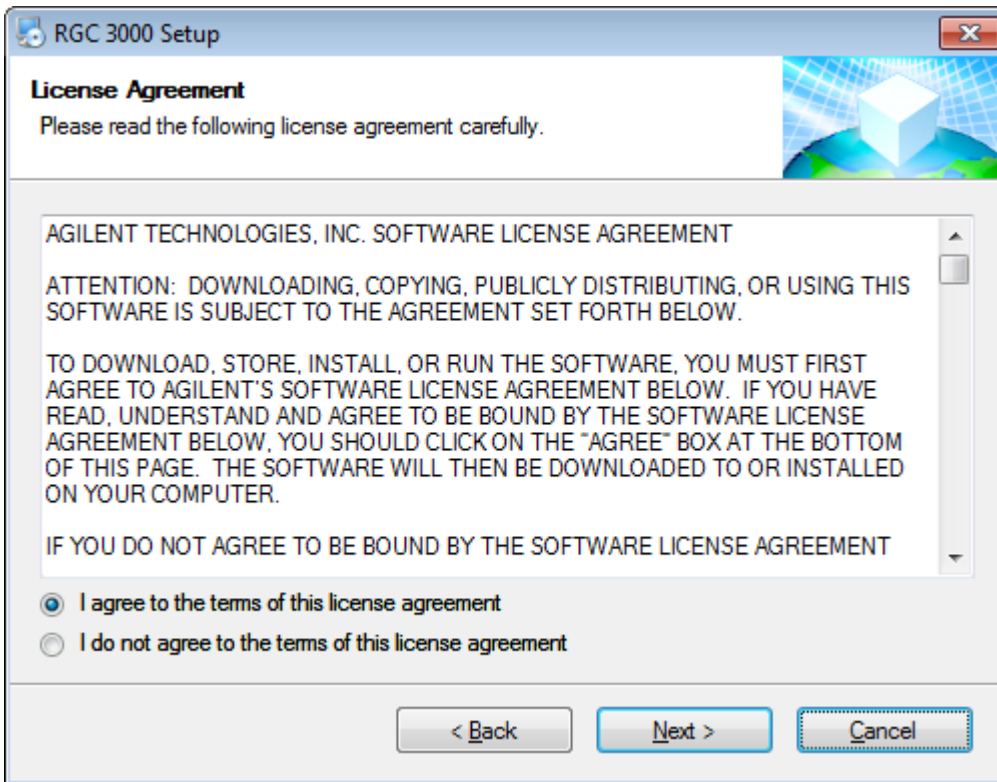

Select the button “I agree to the terms of this license agreement” and click on “Next”.

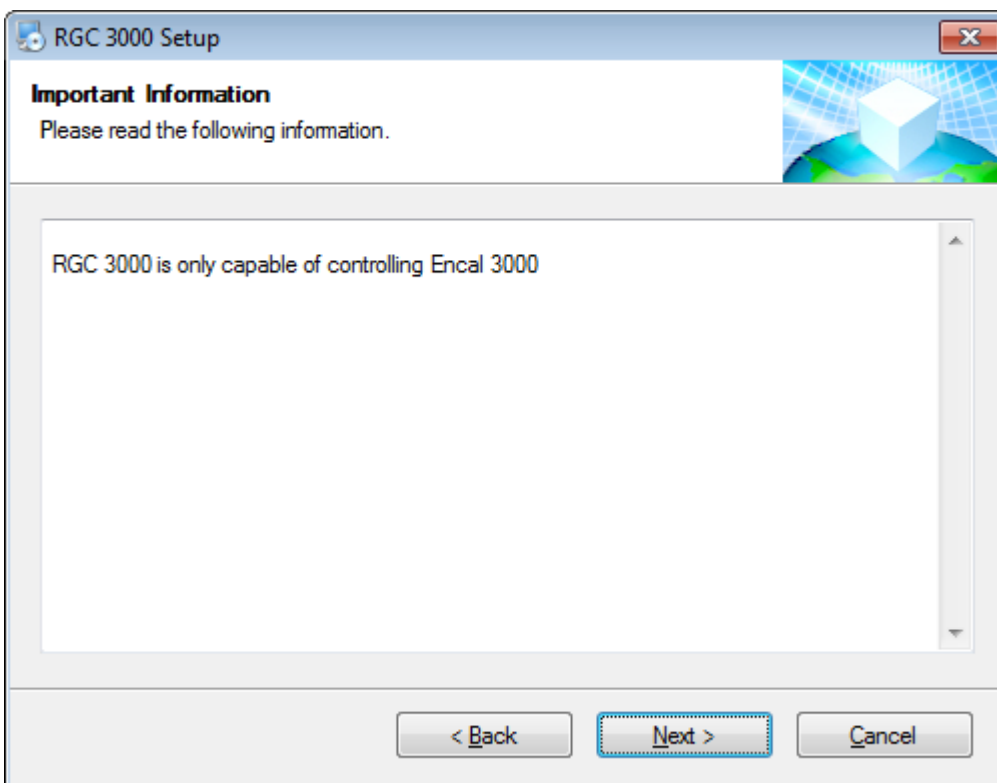

Leave this advice with a click on “Next”

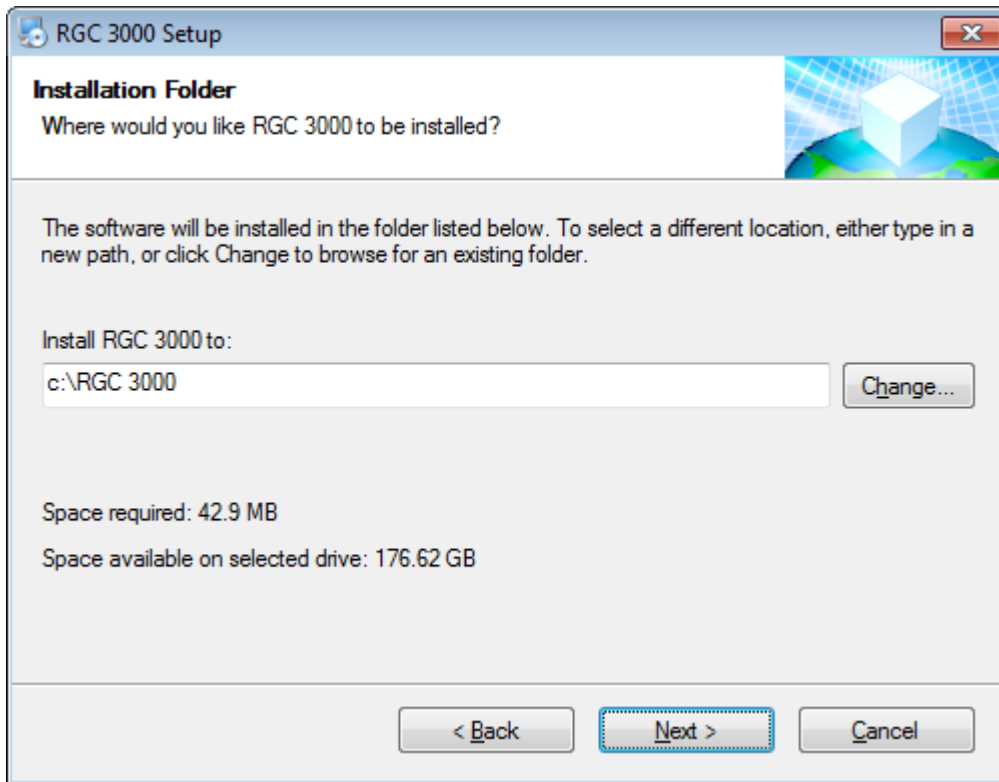

Select the folder where RGC3000 will be installed. Click on "Next".

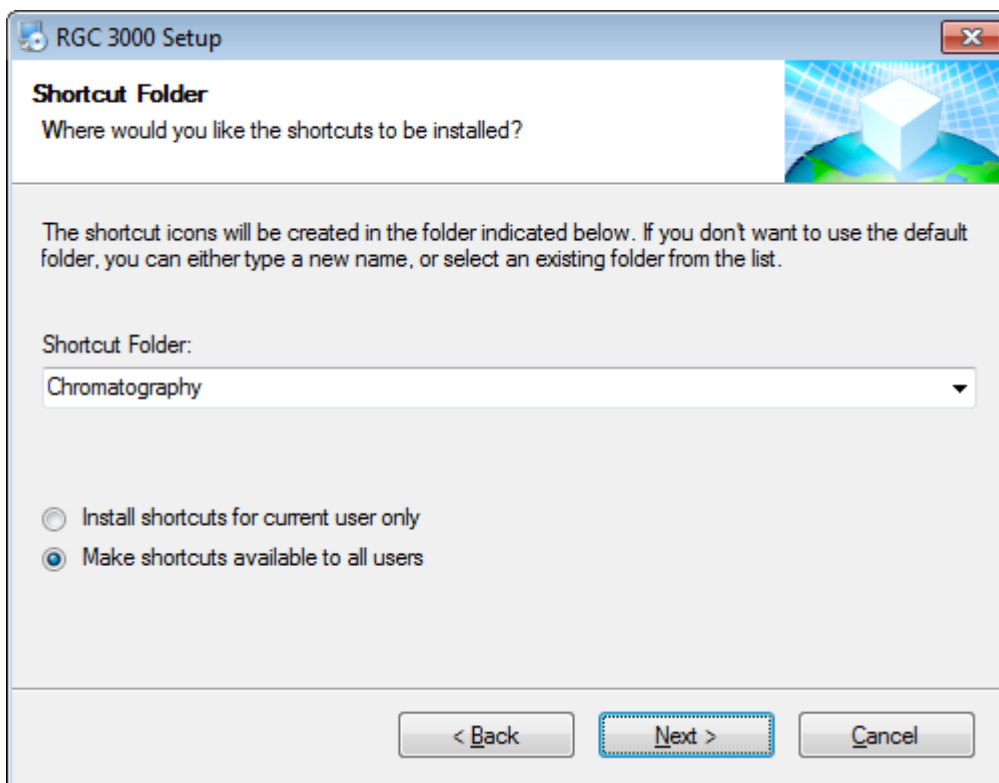

Fill in the name of the Shortcut folder and select whether shortcuts may be available to all users. Then click “Next”.

Note: Installing shortcuts for the current user only is not a hard protection mechanism. Only the current user will have a RGC3000 shortcut in the Windows Start menu. Another user can still run RGC3000 if he finds the PROstation on the hard disk

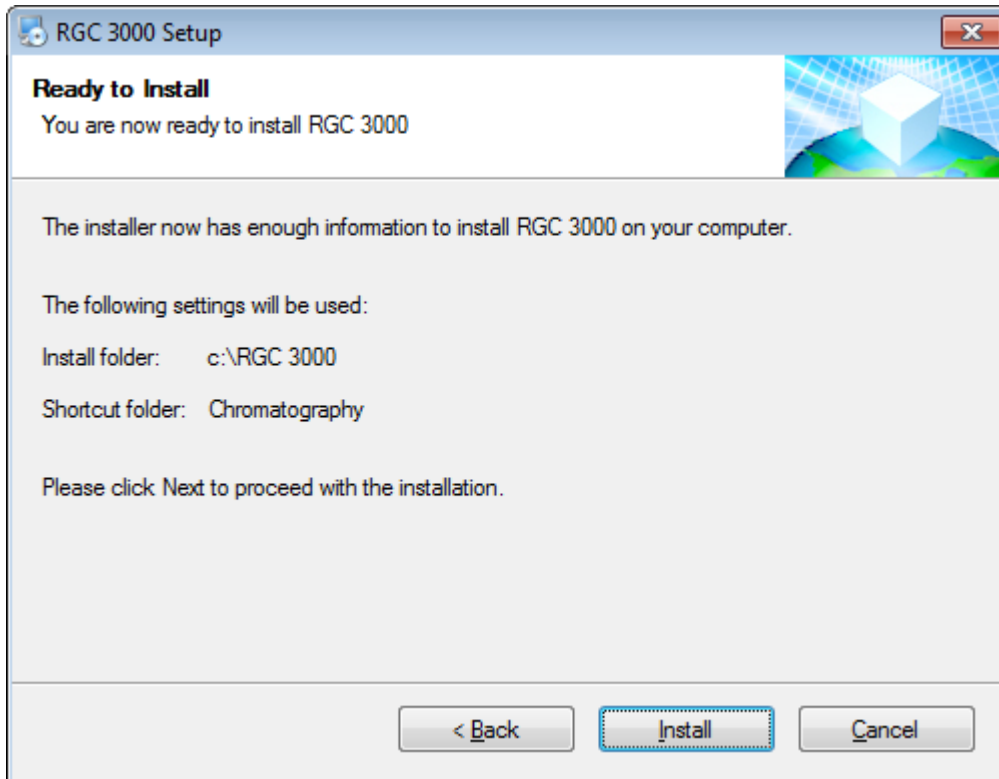

Setup is now ready to transfer files to the computer, click on “Install”.

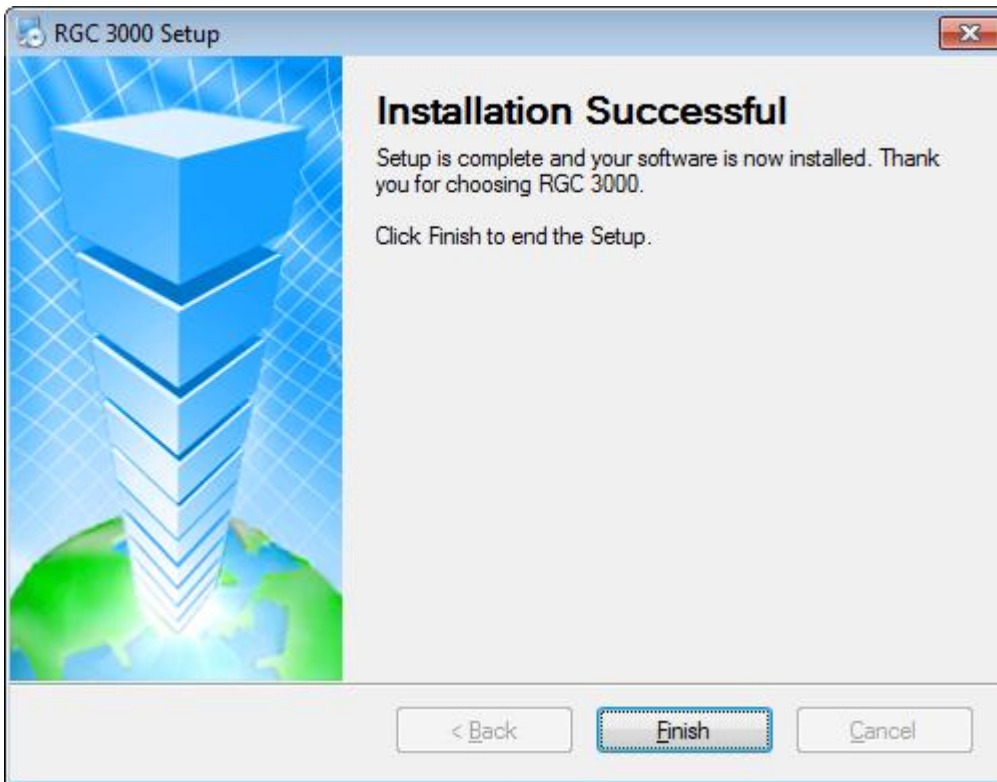

After the installation is finished the computer *must be restarted* to complete the installation.

The Following notice becomes shown

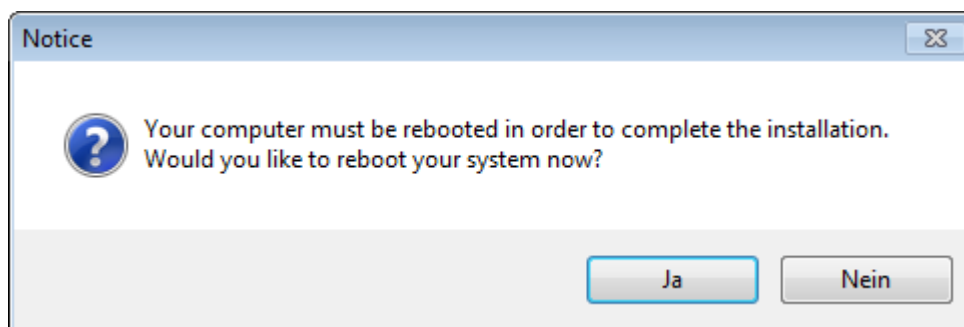

With a click on "Ja" (yes) the computer will reboot.

1.4 WinDCS

Before installation:

Users must log in as a “Windows administrator”.

Make sure no other Windows applications are running during the installation.

After choosing the  SetupWinDCS item from the setup menu a welcome screen will be visible, this shows the software version and displays some important notes.

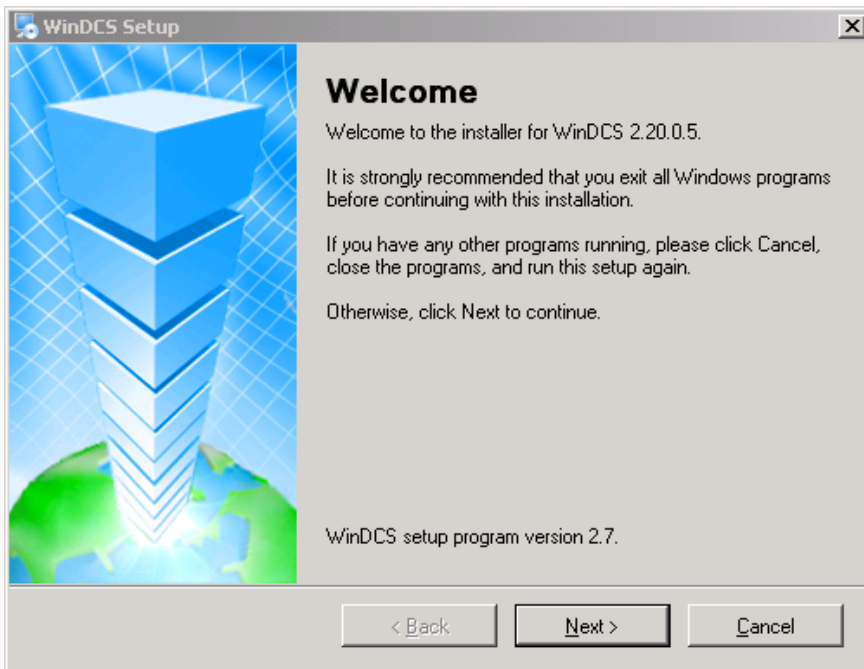

Clicking on “Next” leads to the license Agreement. Read this carefully. Select the button “I agree to the terms of this license agreement” and click on “Next”.

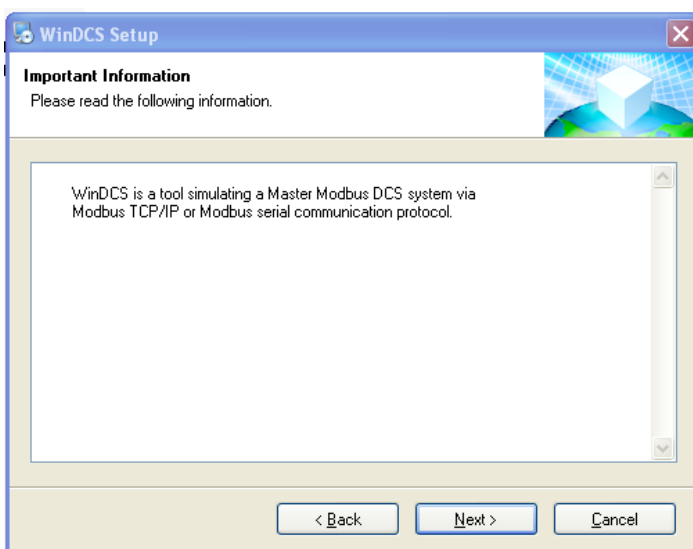

Leave this advice with a click on "Next"

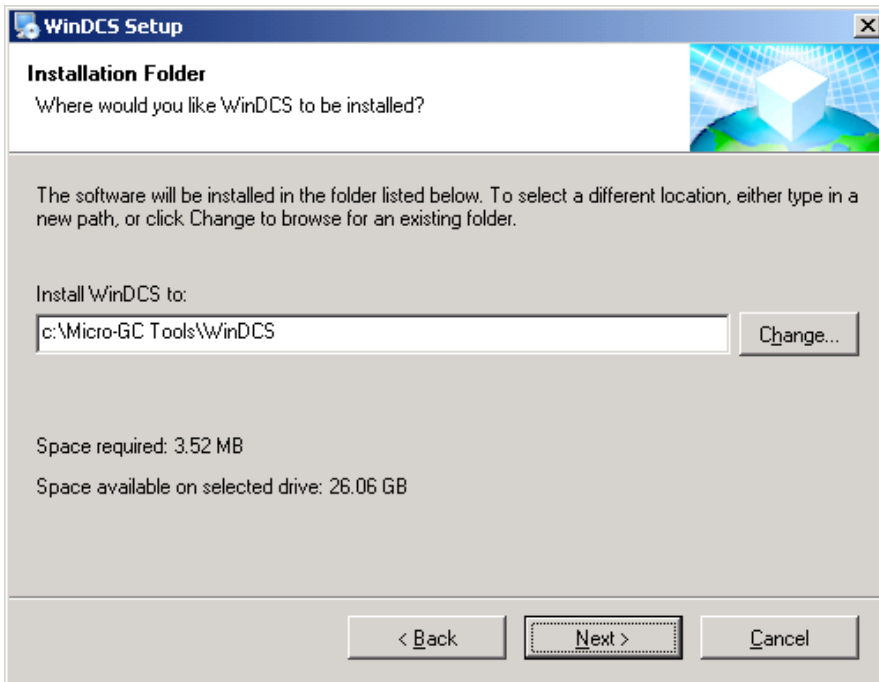

Select the folder where WinDCS will be installed. Click on "Next".

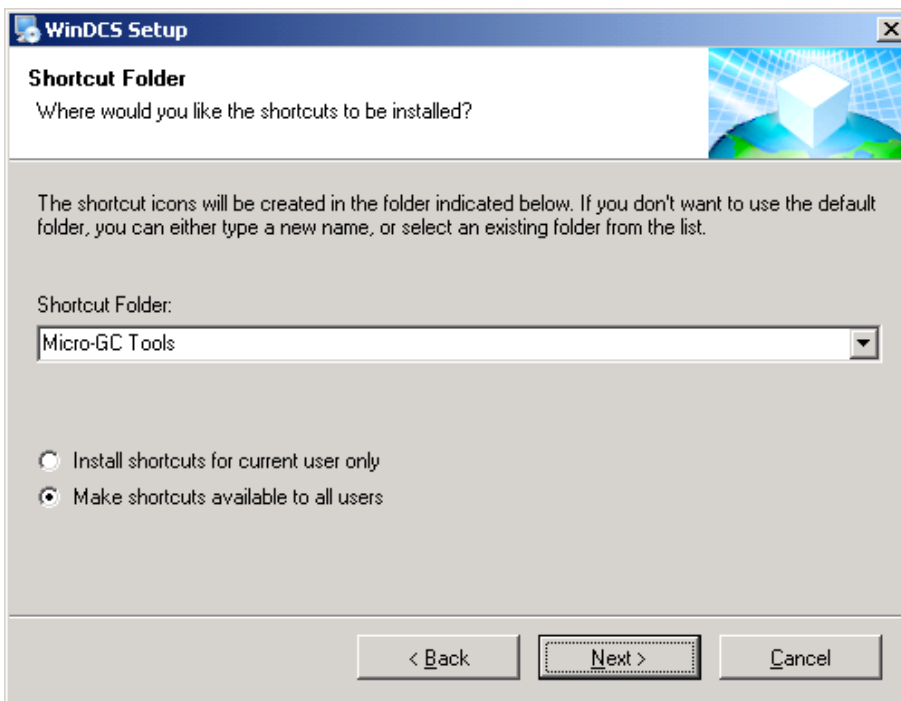

Fill in the name of the Shortcut folder and select whether shortcuts may be available to all users. Then click on "Next"

Note: Installing shortcuts for the current user only is not a hard protection mechanism. To prevent unauthorized access, so please pay attention to an appropriate allocation of access rights.

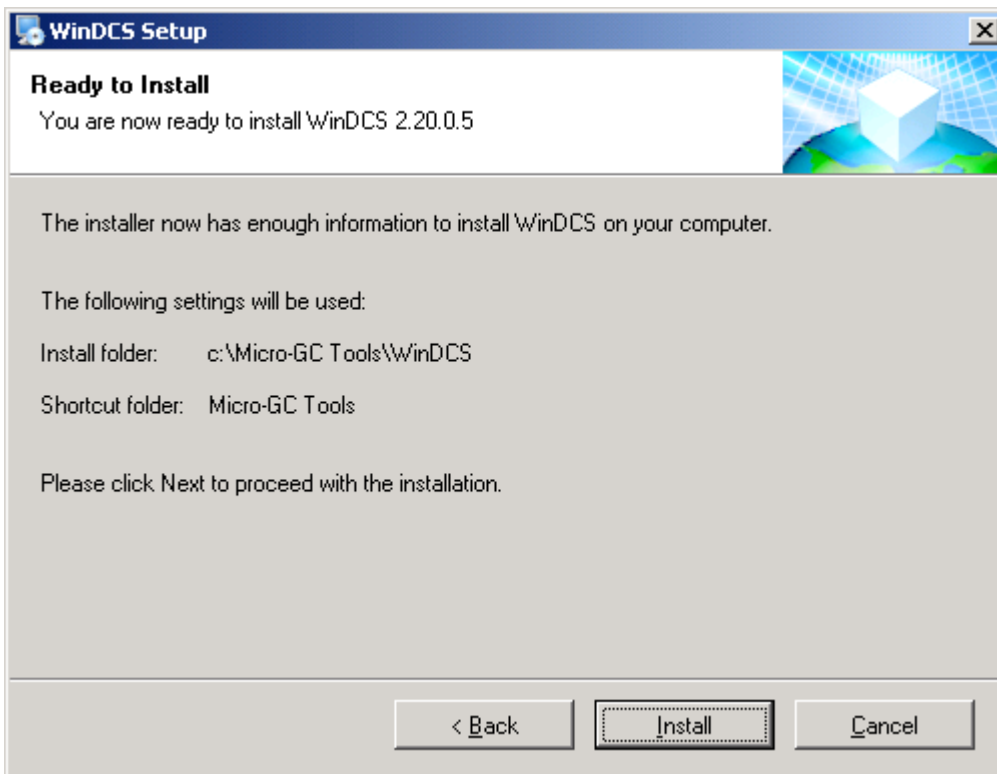

Setup is ready to transfer files to the computer, click on "Install".

After installation close the window with "Finish"

The Following notice becomes shown:

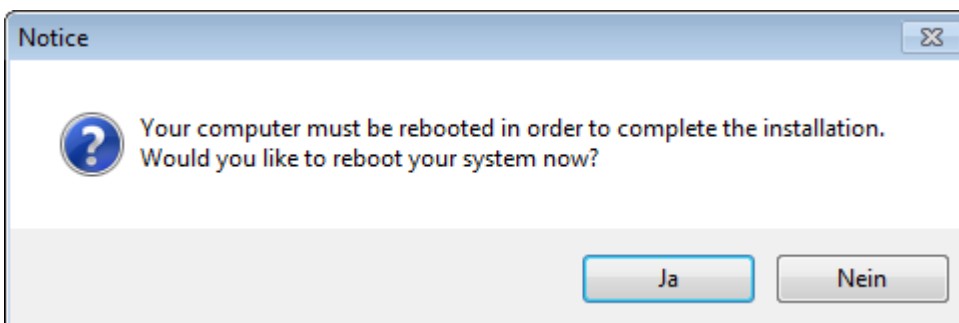

After the installation the computer *must be restarted* to complete the installation. Click on "Ja" (Yes) to do this.

1.5 History Log

Before installation:

Users must log in as a “Windows administrator”.

Make sure no other Windows applications are running during the installation.

After choosing the  SetupHistoryLog item from the setup menu a welcome screen will be visible, this shows the software version and displays some important notes.

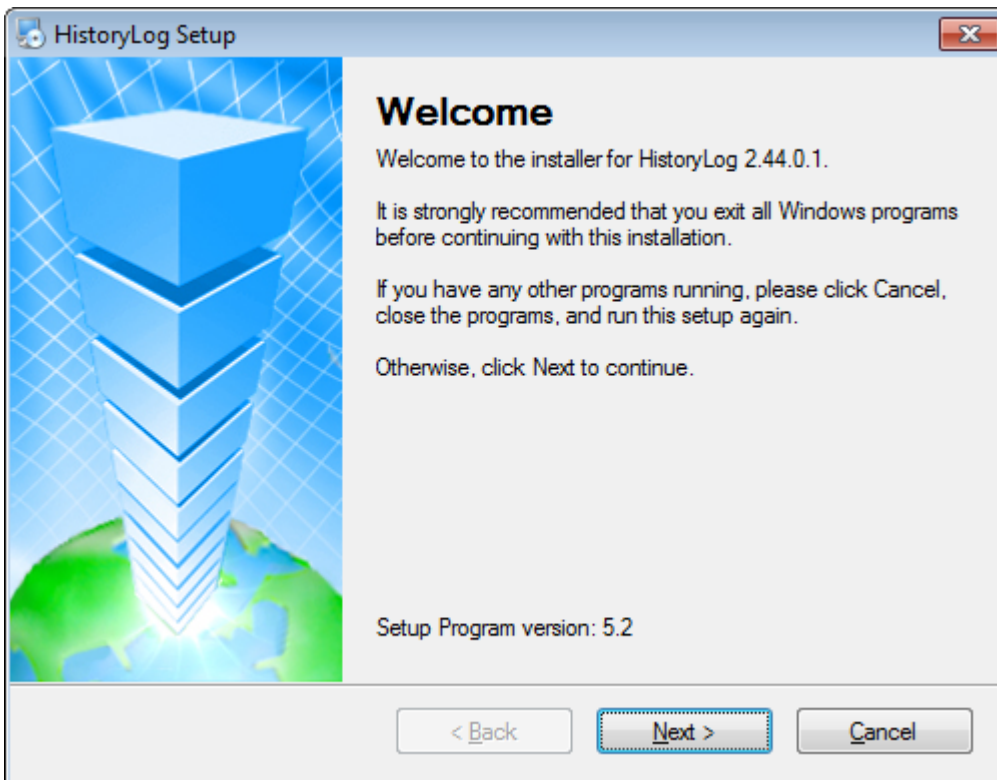

Clicking on “Next” leads to the license Agreement. Read this carefully.

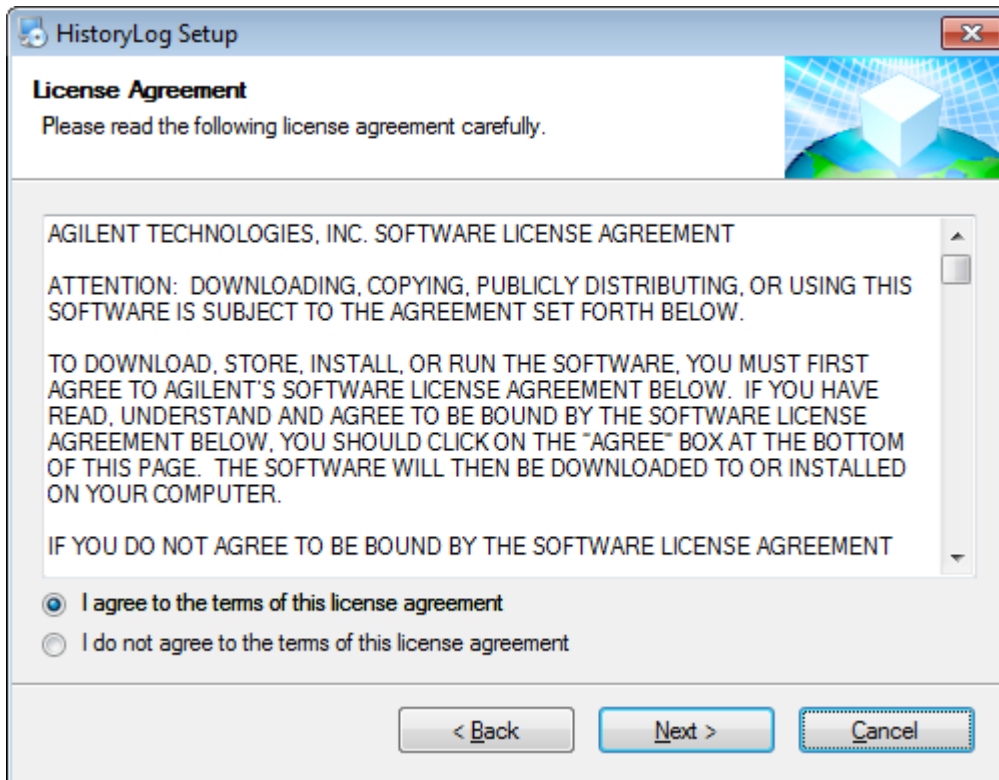

Select the button "I agree to the terms of this license agreement" and click on "Next".

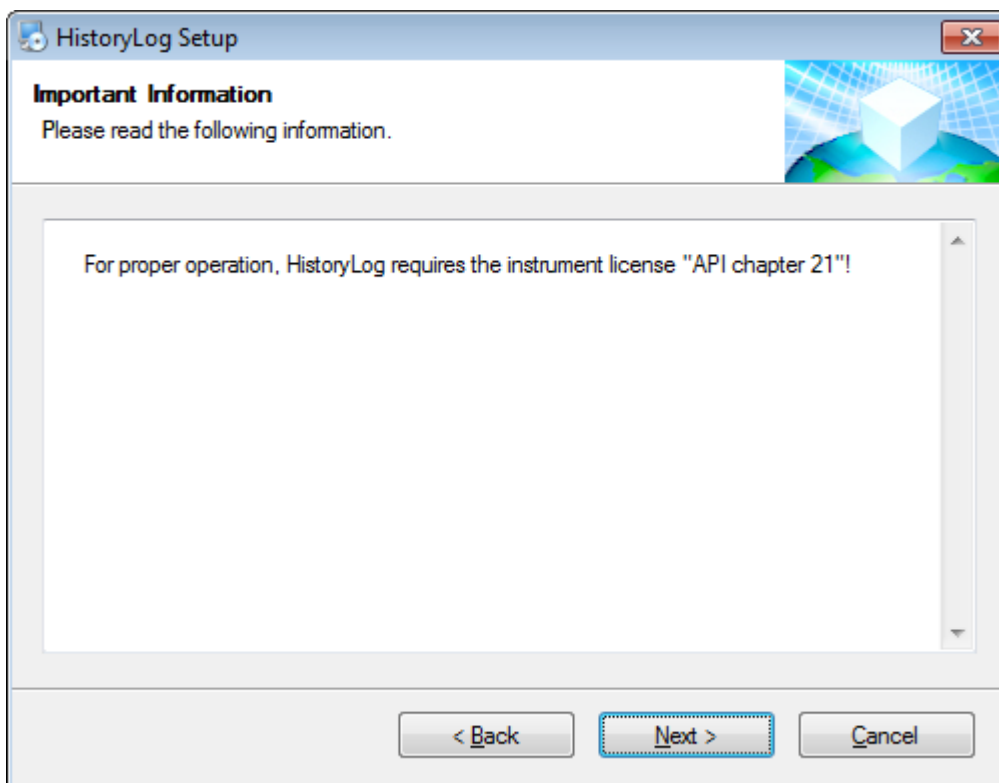

Click "Next" to continue the installation.

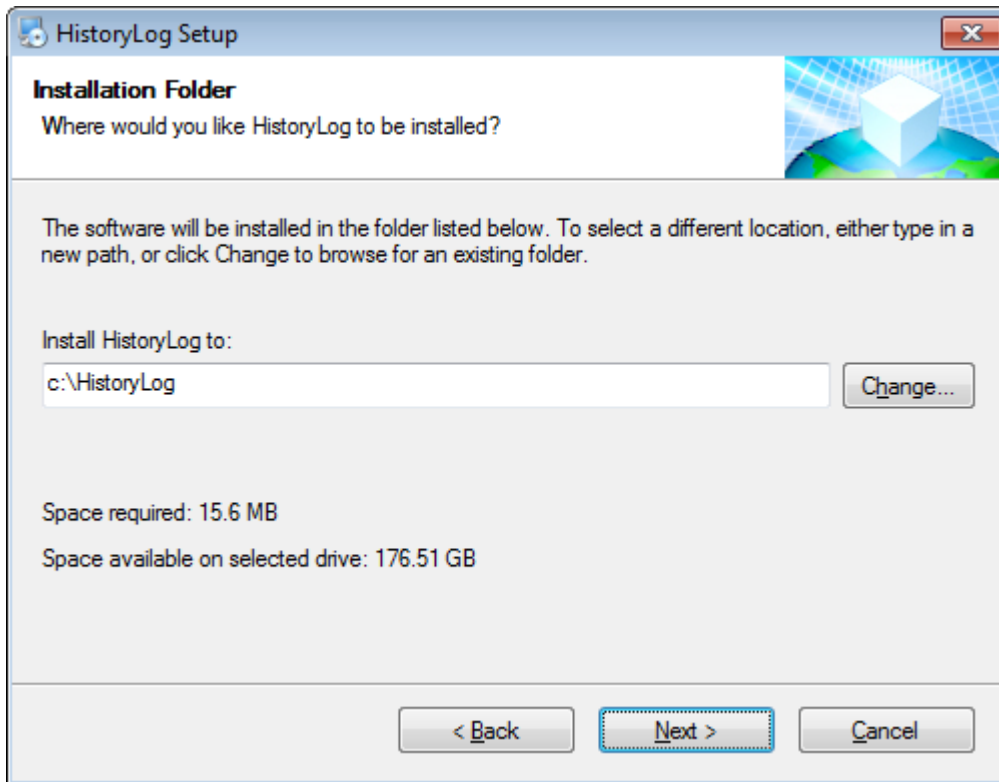

The default installation folder is "C:\HistoryLog". If you want to change this folder click "change" and select another folder. Then click "Next" to continue.

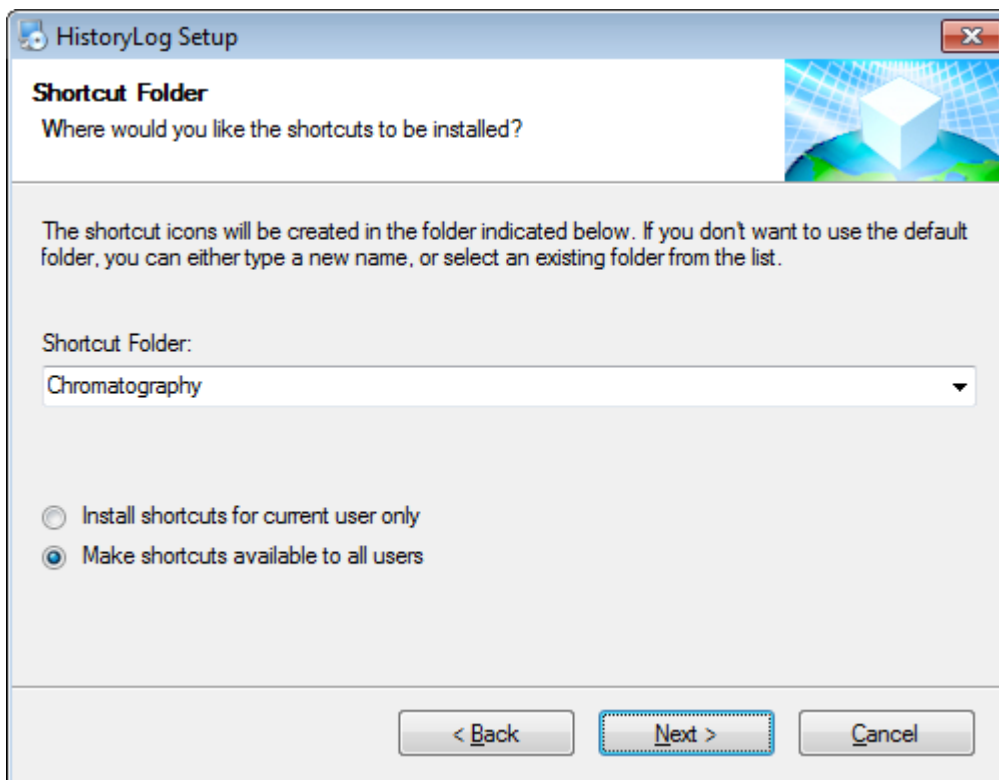

The shortcut folder refers to the icon on the desktop. It is possible to change the default folder. Click “Next” when finished.

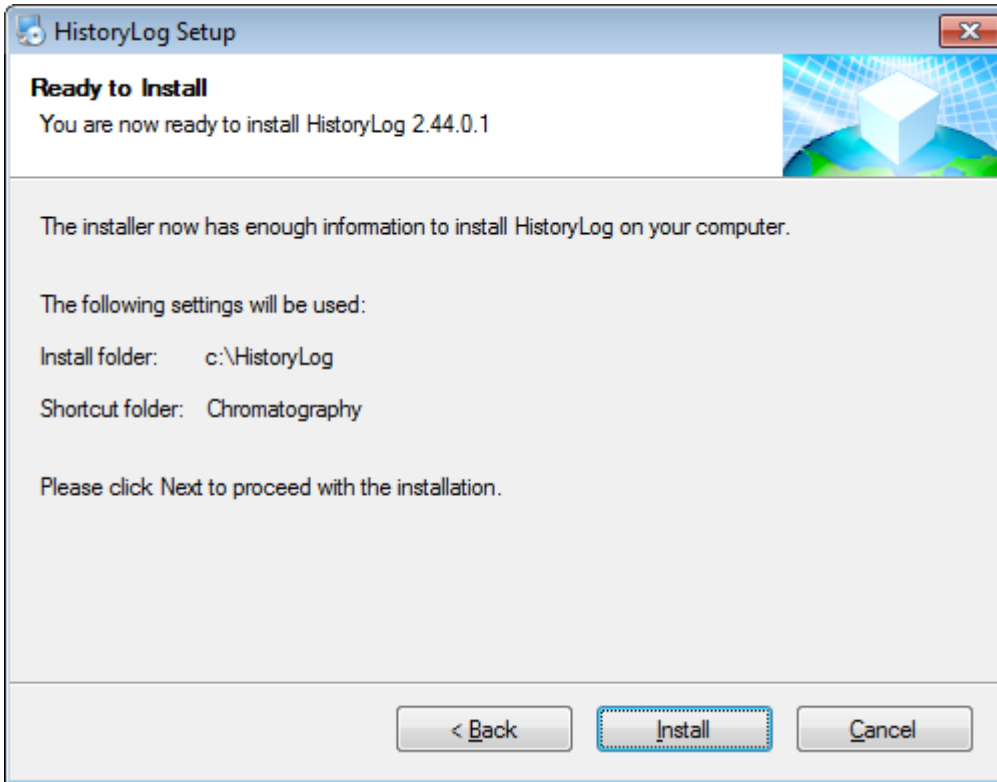

Click “Install” to start the installation. The installation will copy now all files to your computer.

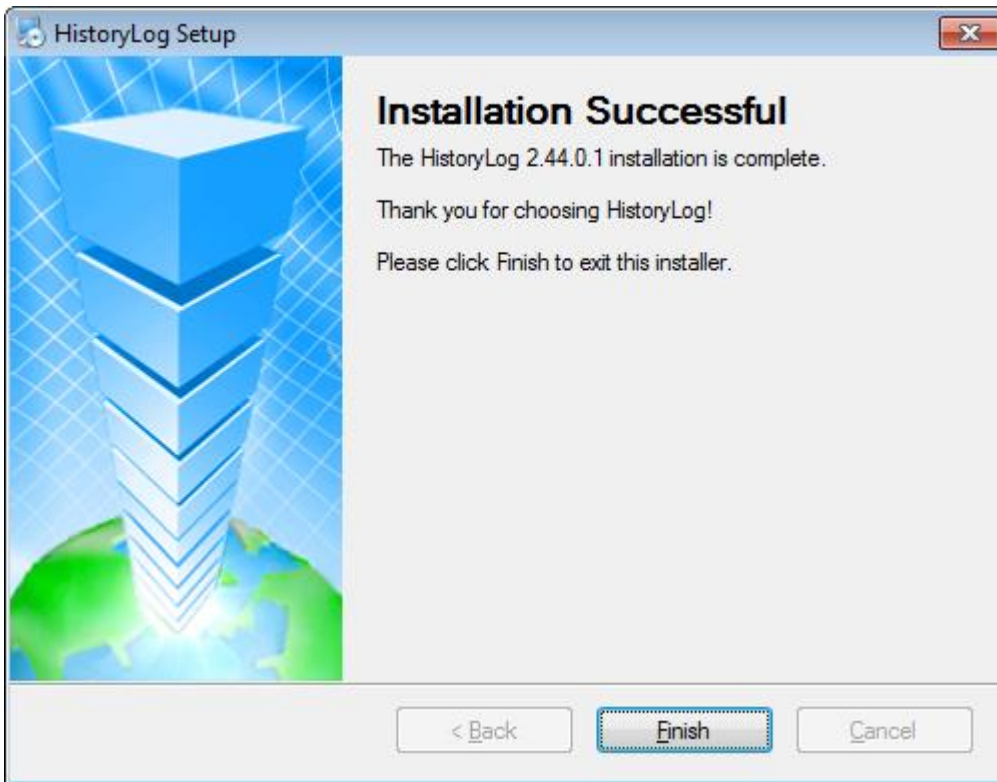

Click "Finish" to end the installation.

After the installation is finished the computer *must be restarted* to complete the installation.

The Following notice becomes shown.

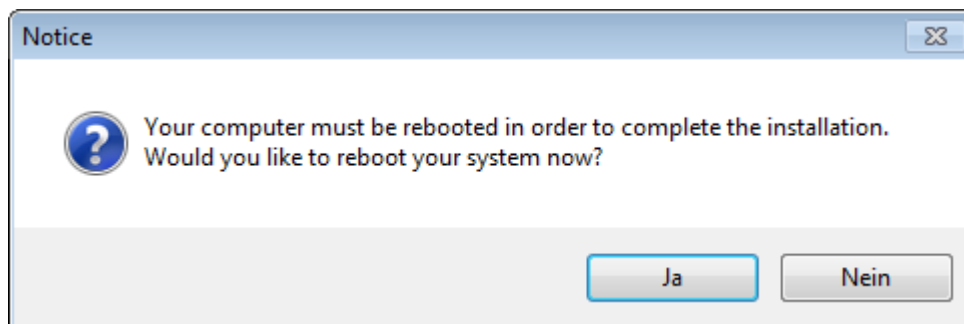

Click on "Ja" (yes) to restart the computer.

1.6 Update MicroGC

If necessary, you will receive a software update. The following section describes the installation and use for the update from version 2.20 build 19606. If you want to update an older version (e.g. 1.4.1) you must first update to version 2.20 build 19606 in a first step. The procedure to do that is given in the attached manufacturer description "firmware_update_manual".

For initial installation and commissioning of new equipment, you can skip this section and continue with chapter 2. If the new mainboard from the type G3581-65000 is used, the firmware version 3.27 should be already installed. This section can also be skipped in this case.

Please note: Versions shown in the pictures of this documentation are not always the same as you will install!

Before installation:

Users must log in as a "Windows administrator".

Make sure no other Windows applications are running during the installation.

After choosing the file  a welcome screen will be visible, this shows the software version and displays some important notes.

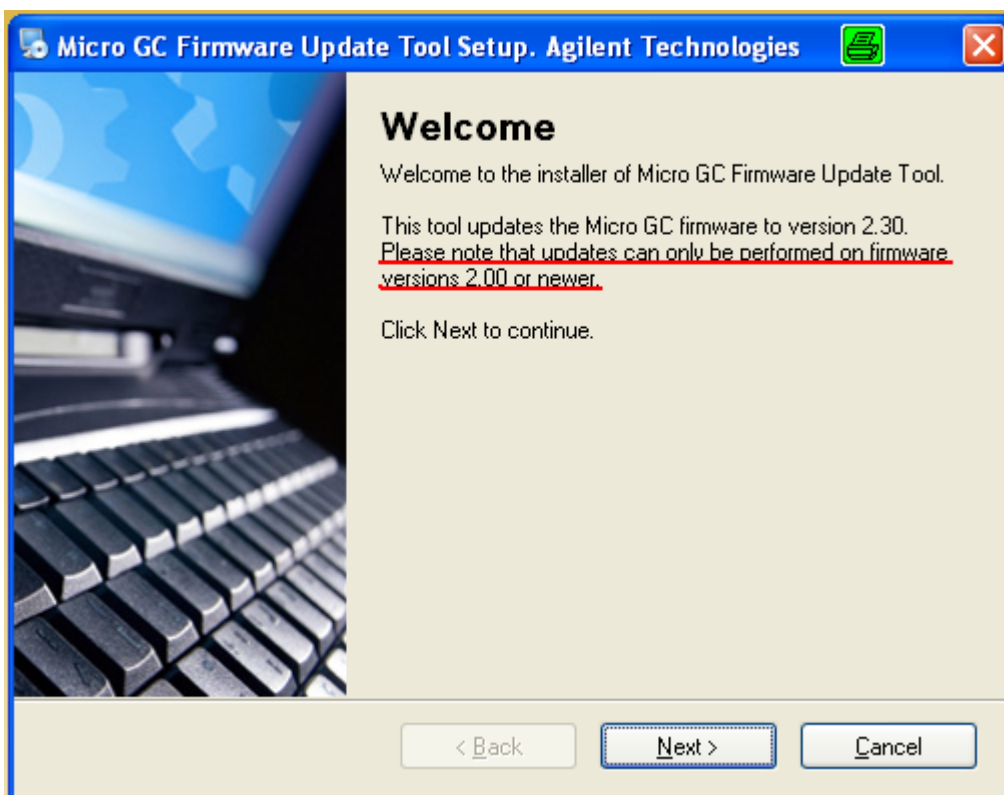

Clicking on "Next" leads to the license Agreement.

Read this carefully.

Select the button "I agree to the terms of this license agreement" and click on "Next".

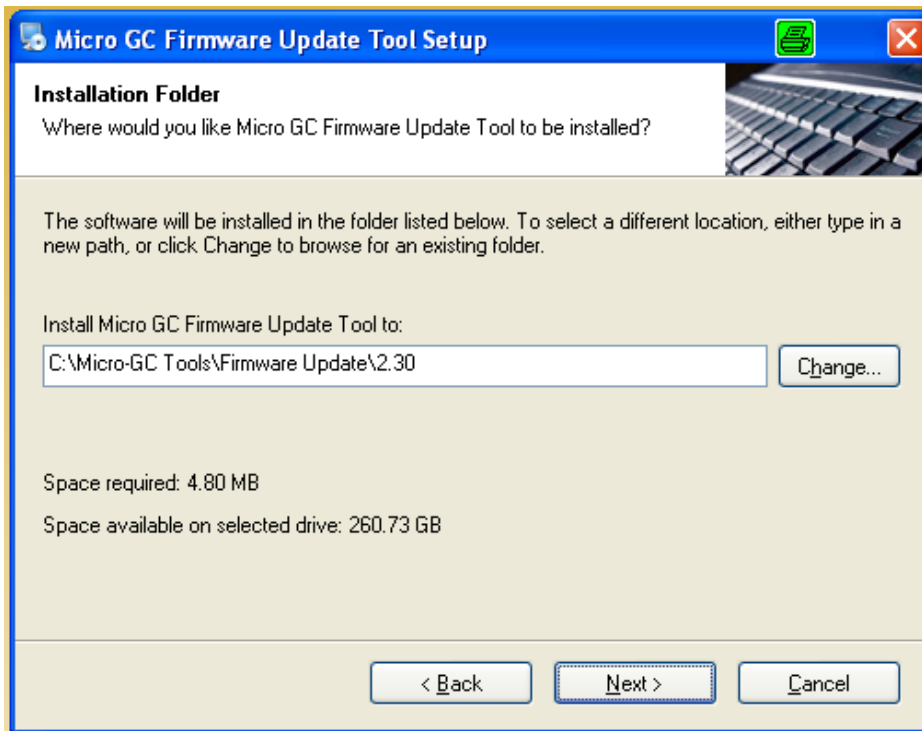

The default installation folder is **C:\Micro-GC Tools\Firmware Update\2.30**. If you want to change this folder click “Change...” and select another folder. Then click “Next” to continue.

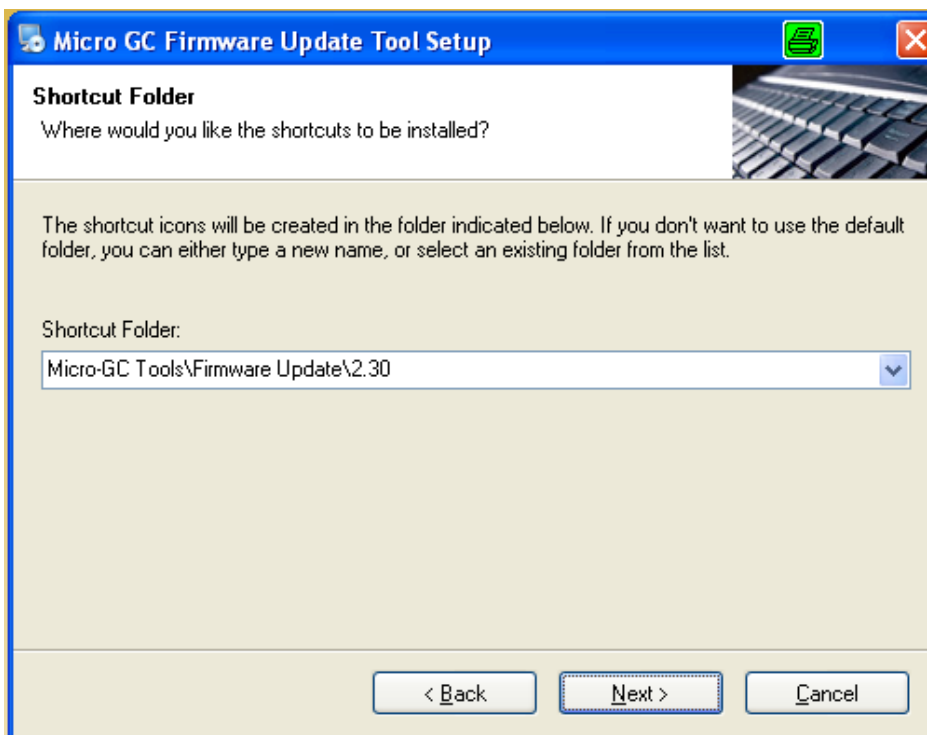

The shortcut folder refers to the icon on the desktop. It is possible to change the default folder. Click “Next” when finished.

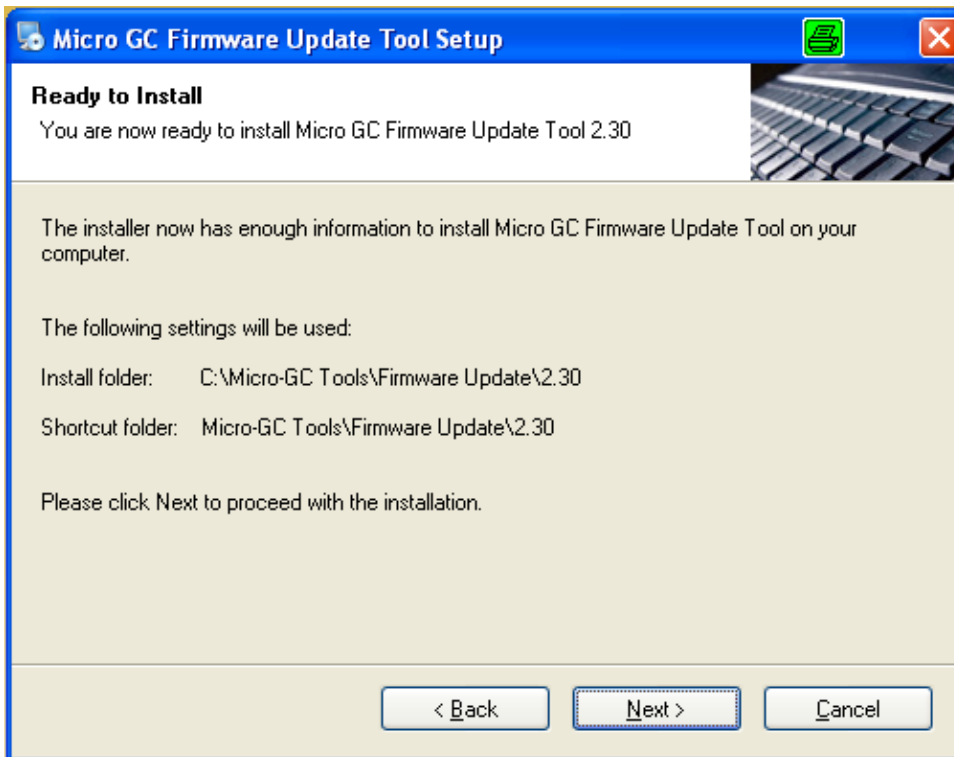

Click „Next“ to start the installation. The installer will now copy all the files on your computer.

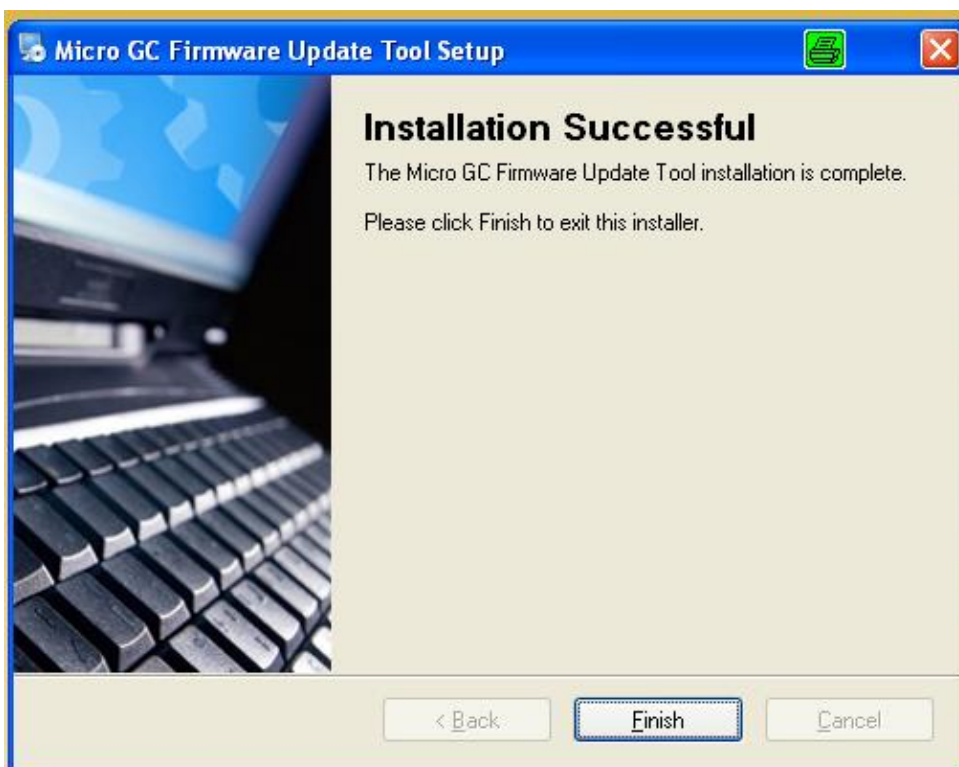

Click “Finish” to end the installation

With the following dialog you can start the program right now, select "Yes" or you can leaf the installation sheet by a click on "No".

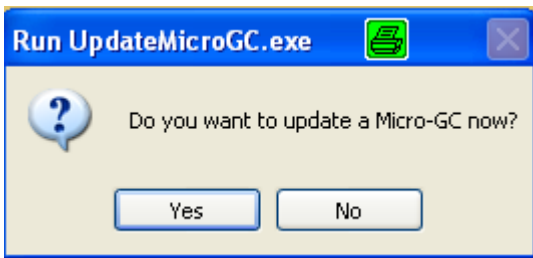

If you have chosen „No”, you can open the update program through the following path:



It appears the launch window "Update Micro-GC" in which you must enter the IP address first.

This requires a proper connection to the GC!

The IP address can be found as described in Section 2.1.

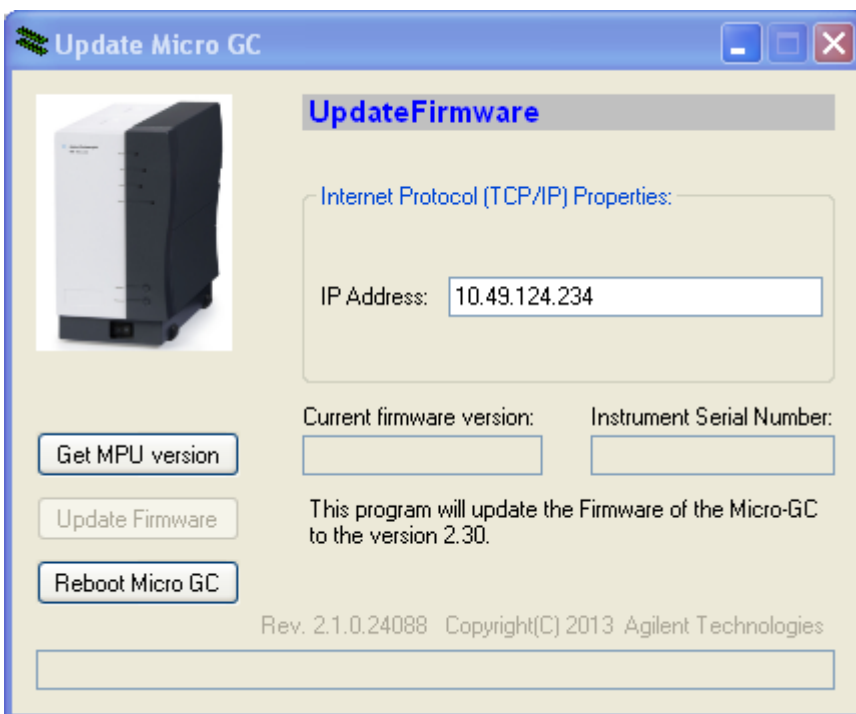

After entering the address in **IP address**, click the button "**Get MPU version**"

The page changes to display the installed version and the serial number. The Update Firmware button becomes active. See the following illustration:

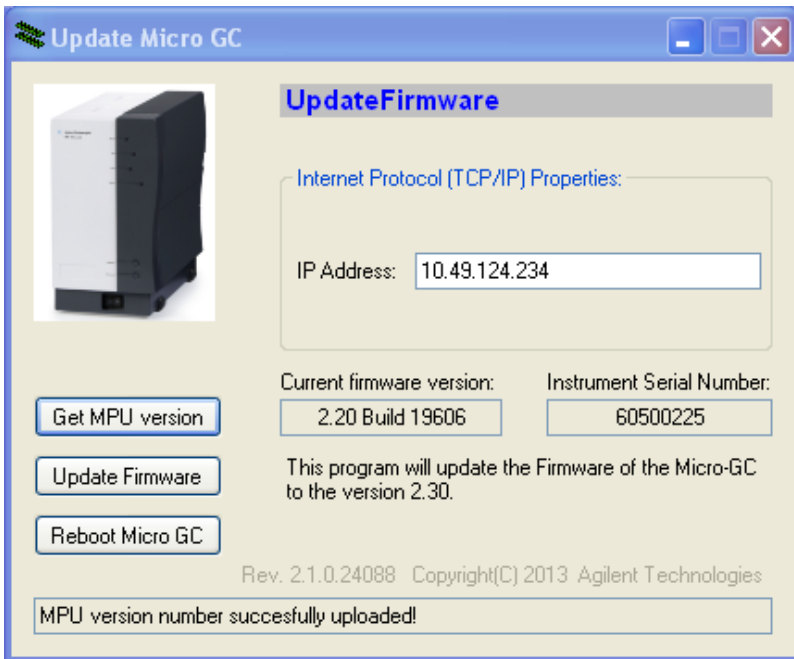

Click on **"Update Firmware"**

The program performs the installation. The editing is displayed in the bottom line.

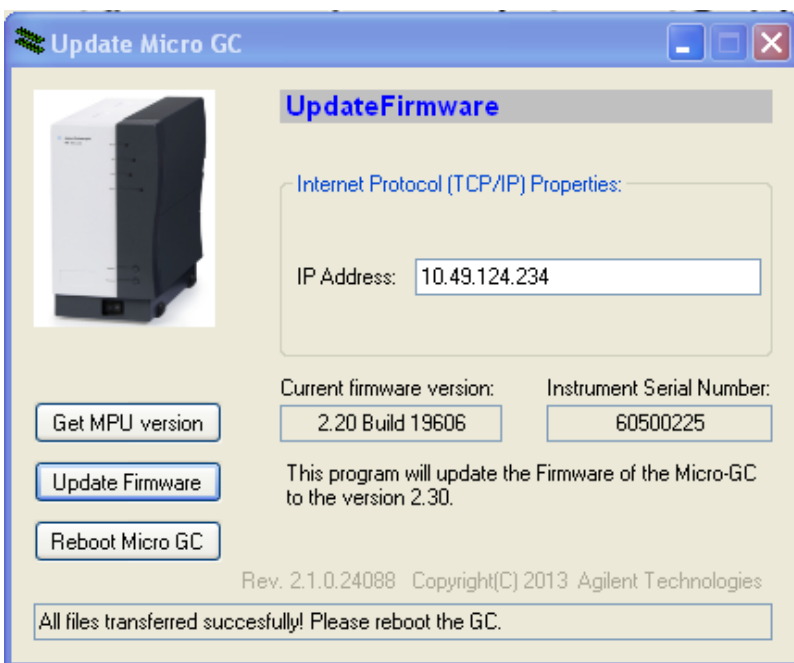

After the transfer, a message appears to reboot the GC. Therefore, click on **"Reboot Micro-GC"**

The GC will then perform a reboot, it takes about 45 seconds.

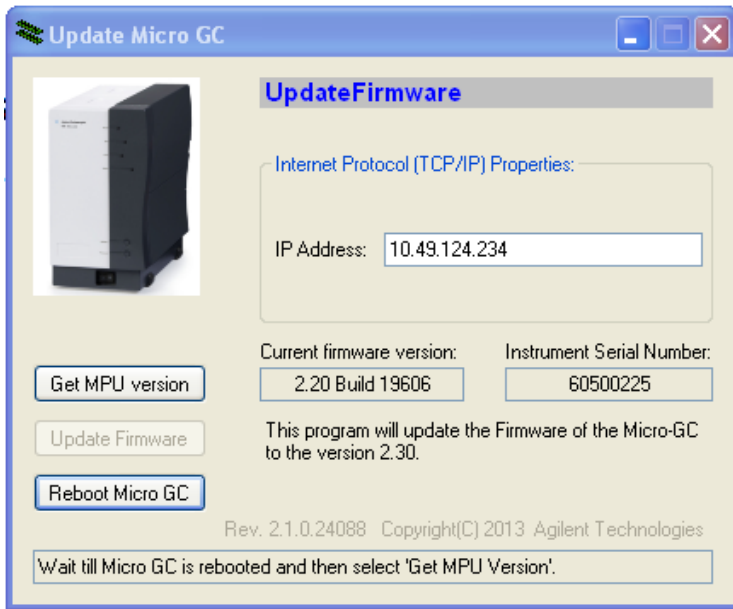

A note on the bottom line is announcing that once again the **"Get MPU version"** function has to be performed after the end of the reboot process. Wait for the reboot time and click the Next button.

(Note: If you click on "Get MPU version" too early an error message appears, you wait a bit and click again.)

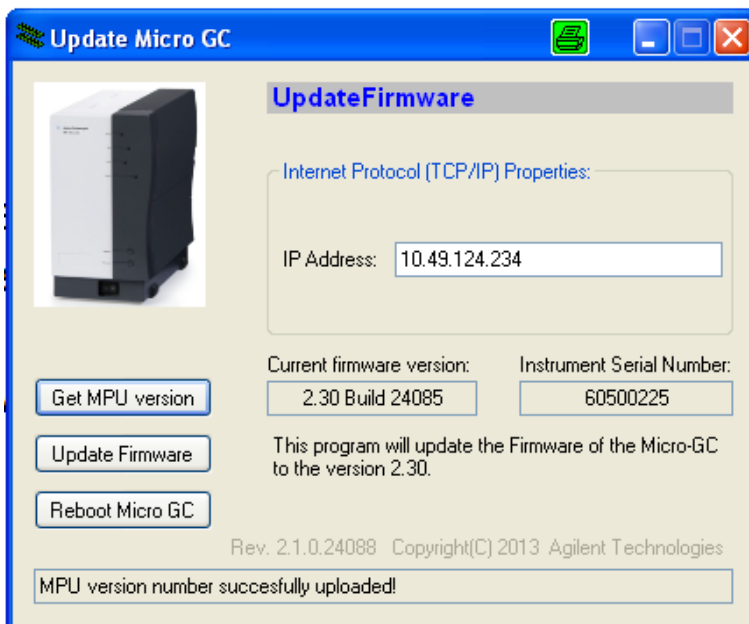

The display is updated to reflect the successful installation of the bottom line known.

Close to exit the window with the X for the operation.

2 IP Settings PC

To establish communication with the GC, both PC and GC have to be on the same network. The default IP settings for the EnCal 3000 are:

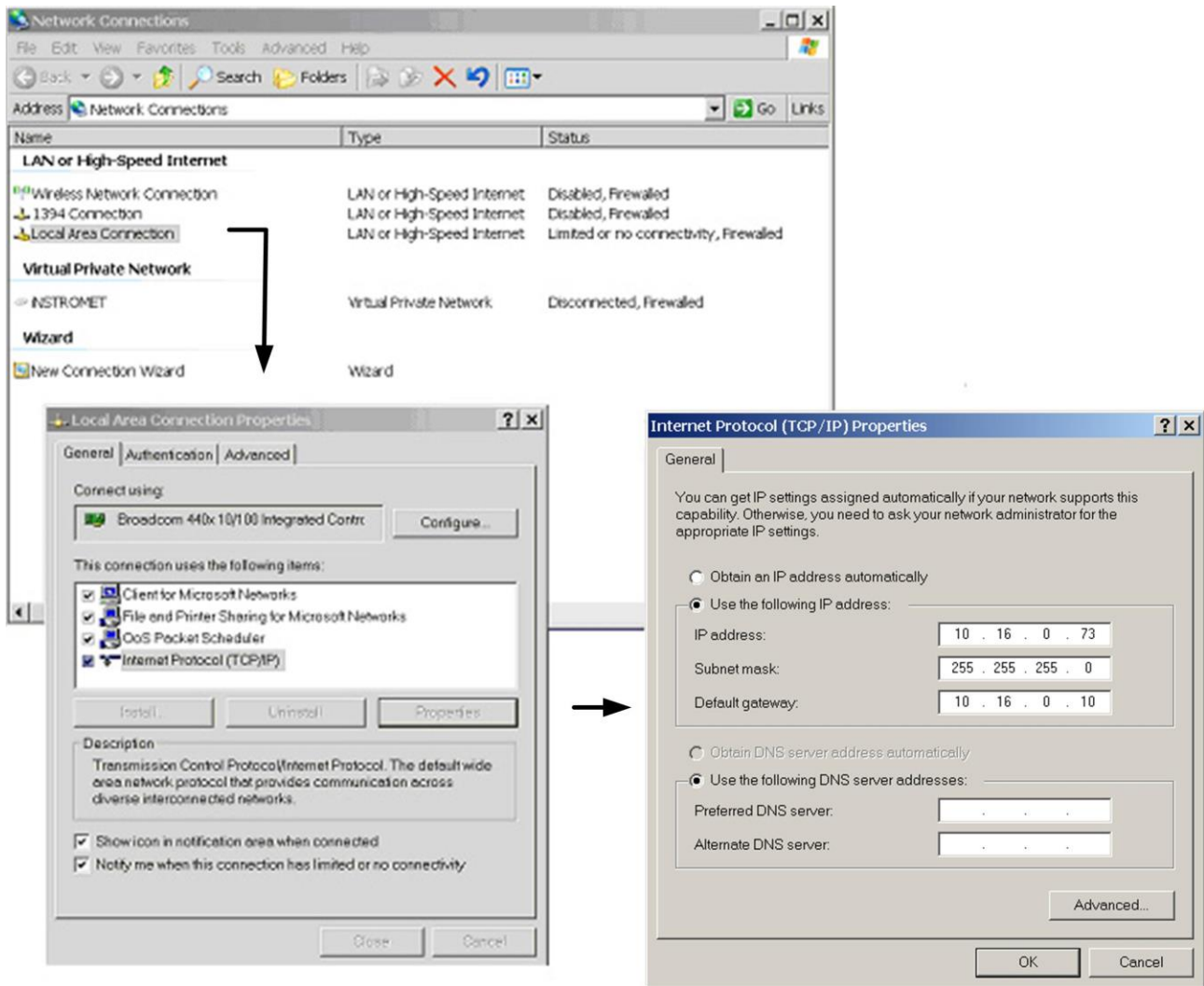

Of course other IP settings are possible. Always make sure however to have the GC and PC operating in the same IP range as defined by the Subnet Mask.

2.1 Configuration with default IP Settings

Double-click the RGC 3000 icon on your desktop and enter the following:

User name : admin
 Login : demo

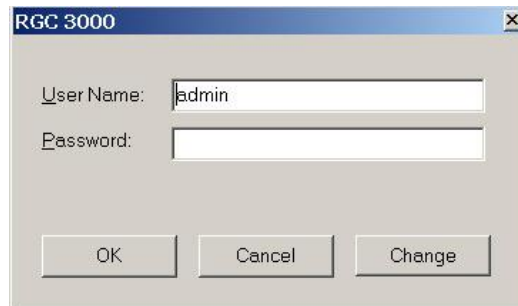

Default the password “demo” is set for the administrator level. Passwords can be changed or deactivated by clicking on “Change”.

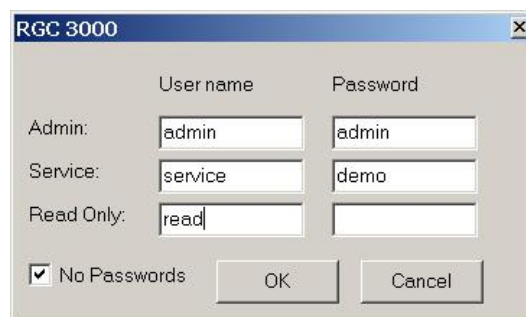

The following screen appears for a few seconds:



After that the Configuration dialog box opens, which gives an overview of the systems installed on the PC. It allows also creating a new instrument with selection of File “New Instrument”.

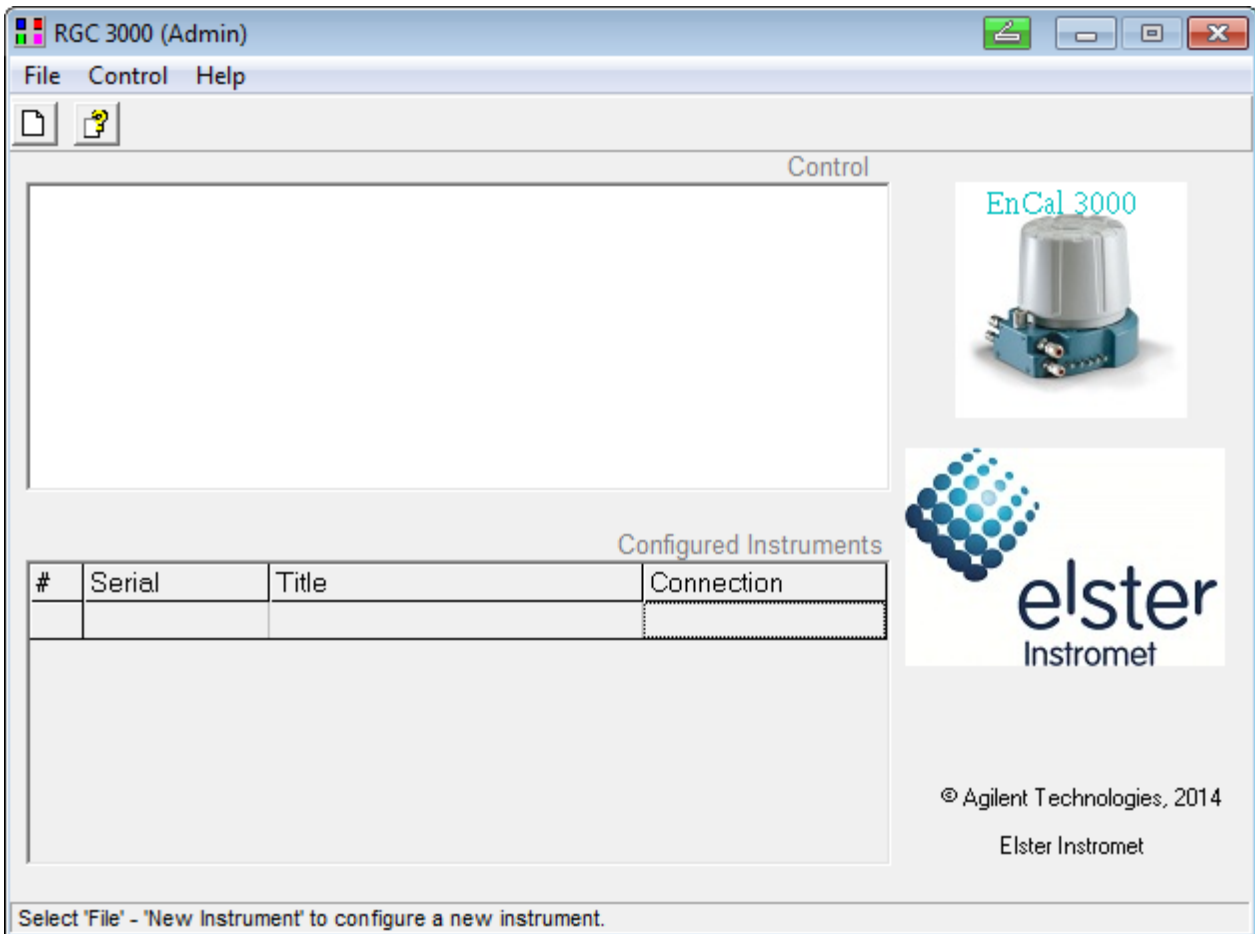

Choose „**New Instrument**“ in **File-Menu**.

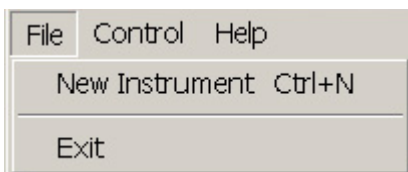

Or click on . The Following window appears:

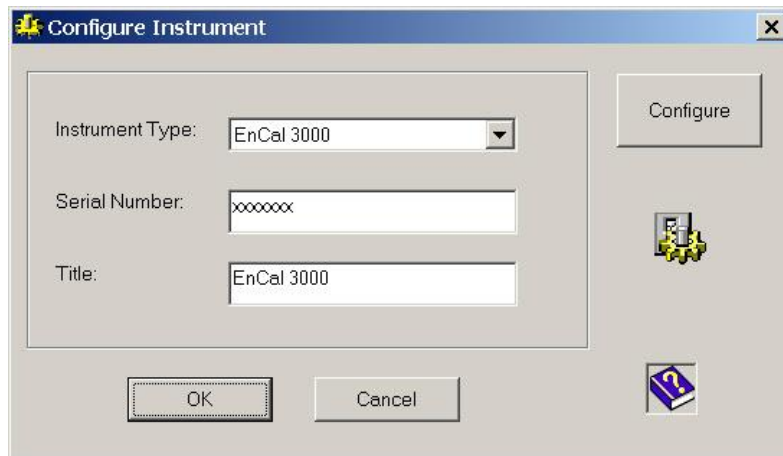

Select "Configure"

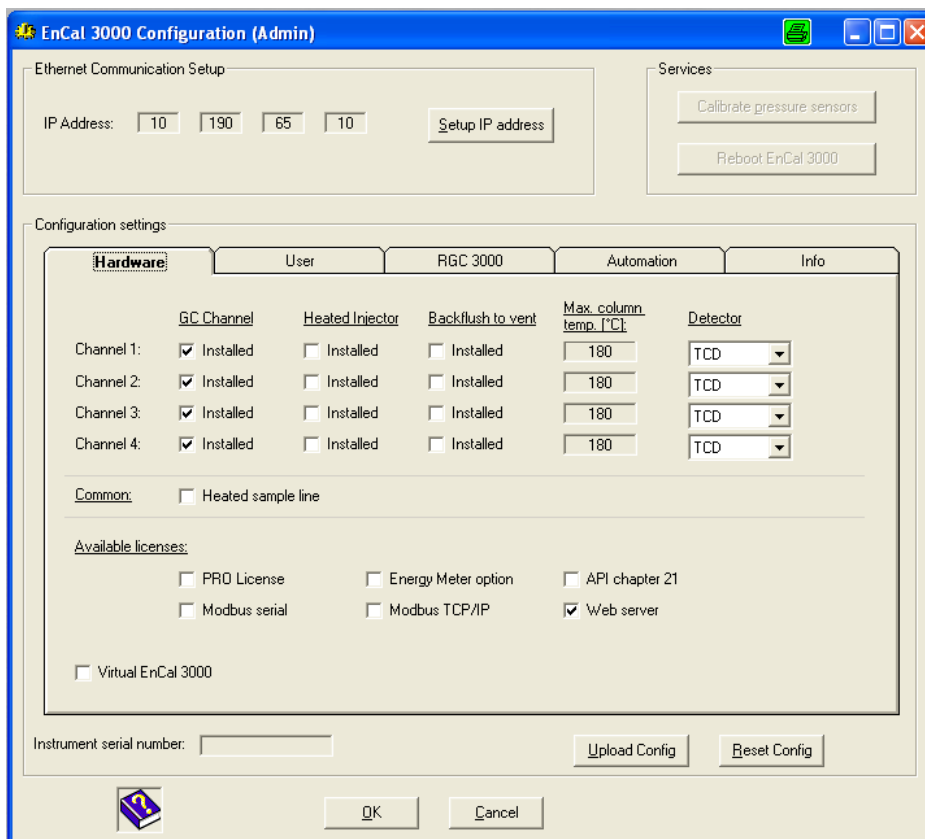

First the IP address has to be defined: double-click the button "Setup IP address" Typically a screen as below appears:

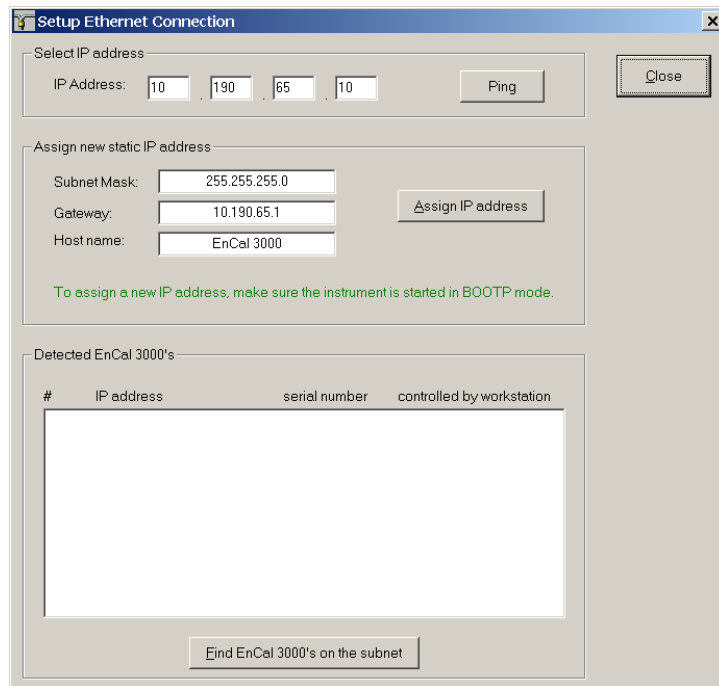

Select "Find EnCal 3000's on the subnet". The GC which is connected to the PC will be displayed in the lower dialog box.

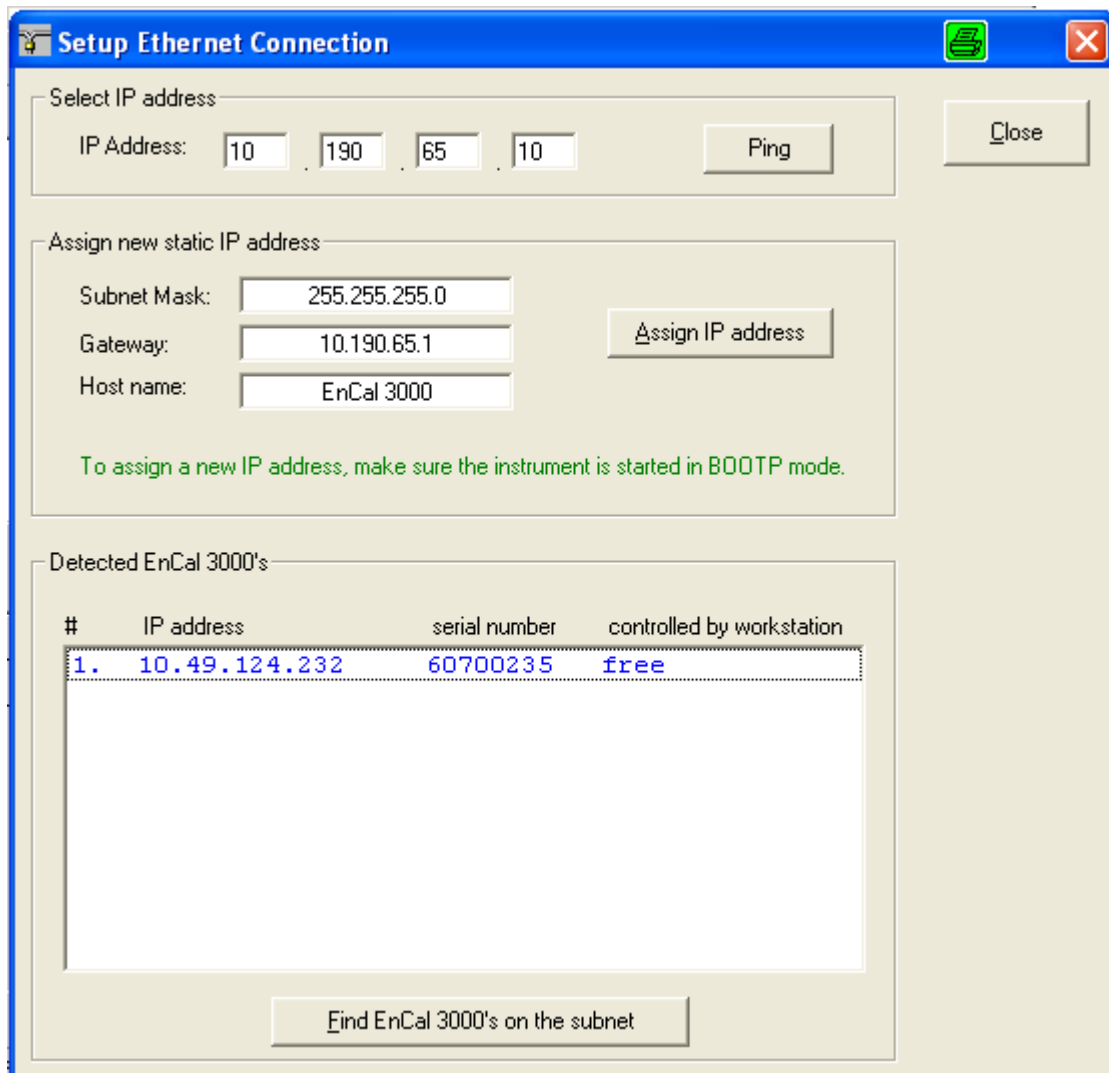

If this is the GC which should be connected to the PC, click on the founded GC

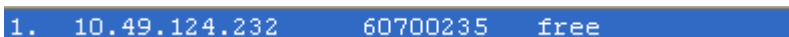

The Following window appears:

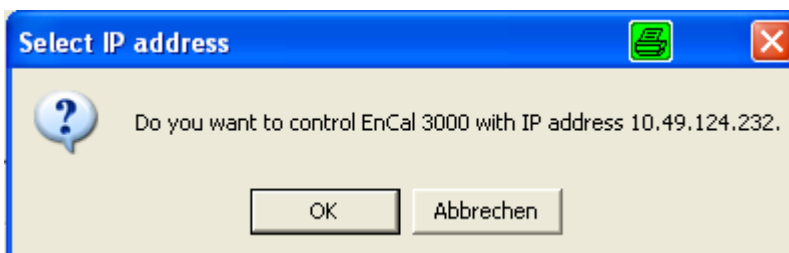

Click OK and close the dialog **Ethernet Connection** by clicking on the **Close** button. Follow the instructions in chapter 2.3, to continue with the configuration.

2.2 Configuration with customer specific IP Settings

In case of the message “No EnCal 3000 found!” in the lower dialog box, there are 2 options:

- The IP address of the GC is not compatible with the IP settings of your PC. In that case new IP settings have to be assigned to the GC: see procedure on the next pages.
- Or something is wrong with the physical data communication. See Hardware manual Chapter “Hardware Installation” for the correct cabling configuration of the Ethernet cable.

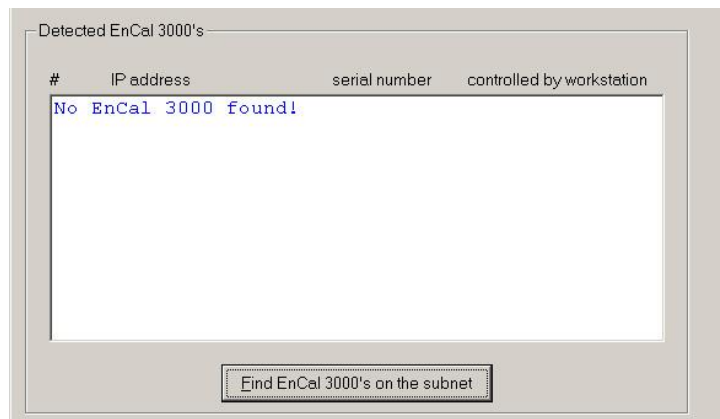

Assign of an IP address with the old mainboard CP740010 (used until end of 2014):

- First the unit has to be set in BootP mode. Restart the unit while pressing the BootP button, located left above the Ethernet connector on the Processor Board

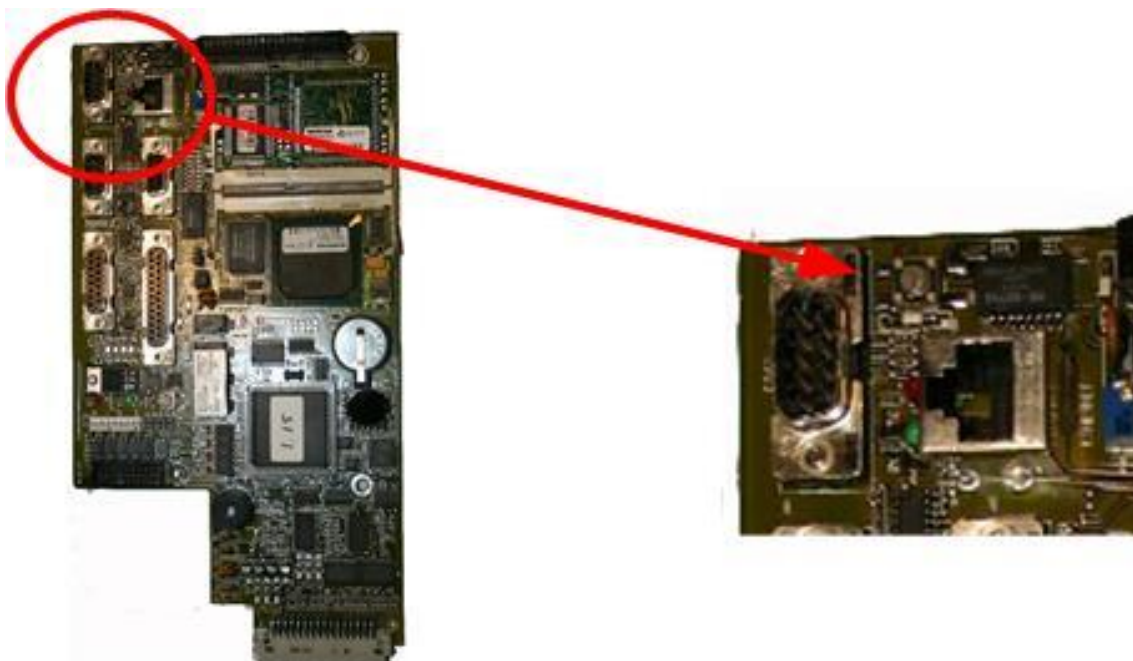

Hold the button during about 35 s, till 2 green LED's at the back of the Processor Board flash at a frequency of 1 Hz (during the start-up cycle, the 4 LED's at the back of the processor board will run continuously through a cycle of Green/Red/Orange/Green), which indicates the BootP status.

- First enter the desired IP settings for the GC in the Dialog Box and select then “Assign New Address”

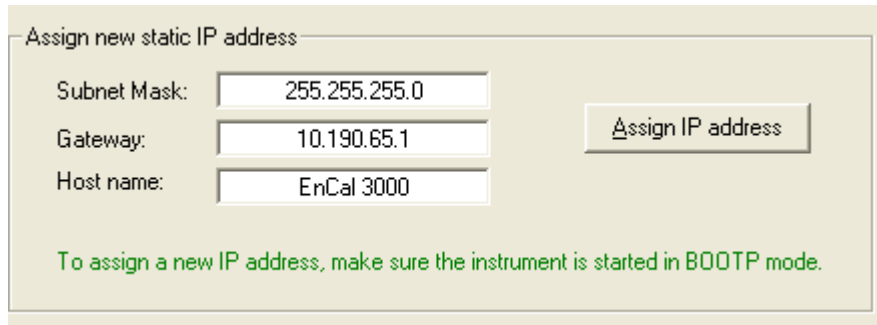

The IP settings will now be downloaded to the unit. This takes on average about 20s. When successful, the following message appears:

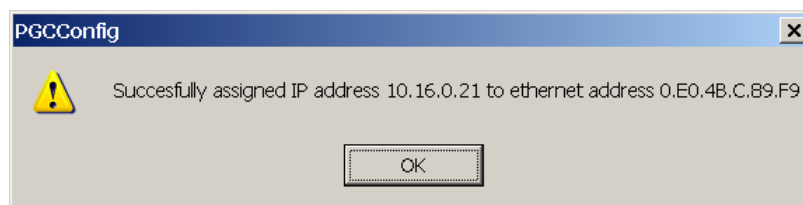

Select OK

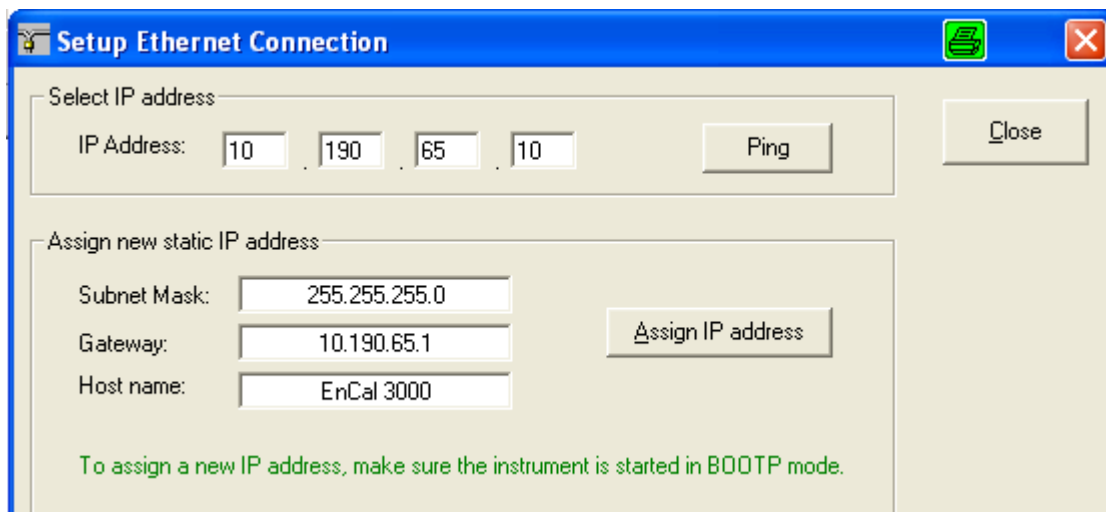

Close the dialog box “Ethernet Connection”.

Assign of an IP address for an Encal3000 with new main board (type G3581-65000)

The procedure for assigning an IP address depends on which main board your GC has installed. This procedure is for GC's with main board G3581-6500. For GC's with old main board CP740010, follow the procedures described in the previous pages. Upon arrival from the factory, the GC has a default static IP address

configured. The active IP address is specified on the sticker together with the MAC address and the main board serial number (see following table)

Factory default IP address settings	
Default IP address	192.168.100.100
Subnet mask	255.255.255.0
Host name	microgc
Default Gateway	N/A (not used)

1. To complete this procedure, the Micro GC must be in static IP address Mode. To verify this, be sure the DHCP switch, is in the left position. The DHCP switch is located on the back of the main board (see following picture).

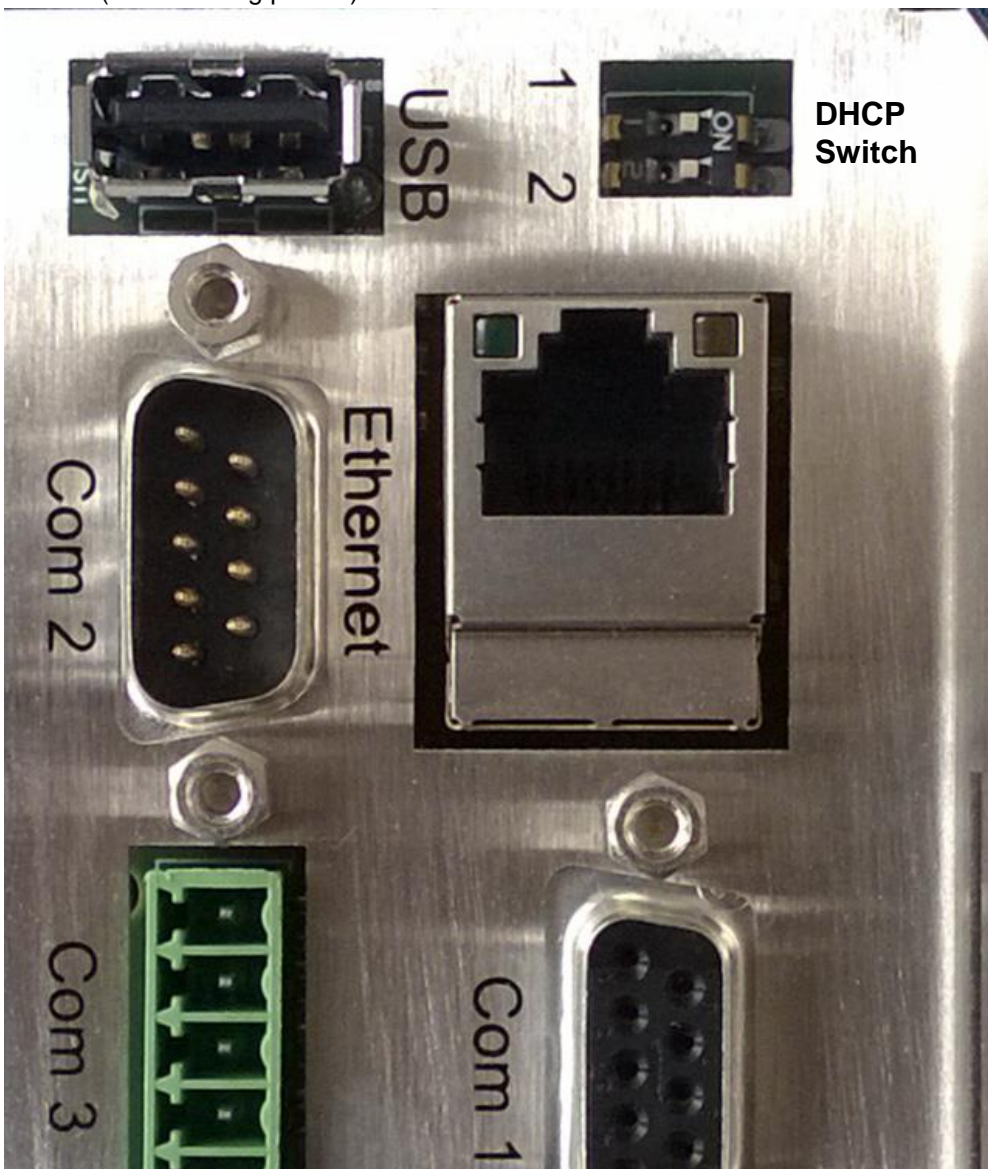

2. Change the IP address of your laptop or PC to an address in the same range as the current IP address as the Micro GC.
3. Start up your web browser.

4. Connect to the Micro GC's website. Type the IP address of the Micro GC in the address field of the web browser.
5. On the web page, click **Network**.
6. Log in as administrator. Use the factory default login and password:
Login name: admin
Password: agilent



7. In the network webpage, the upper section shows the current IP configuration. Type the **IP Address**, **Subnet mask**, and **Gateway** you want to assign to the Micro GC in the corresponding fields.

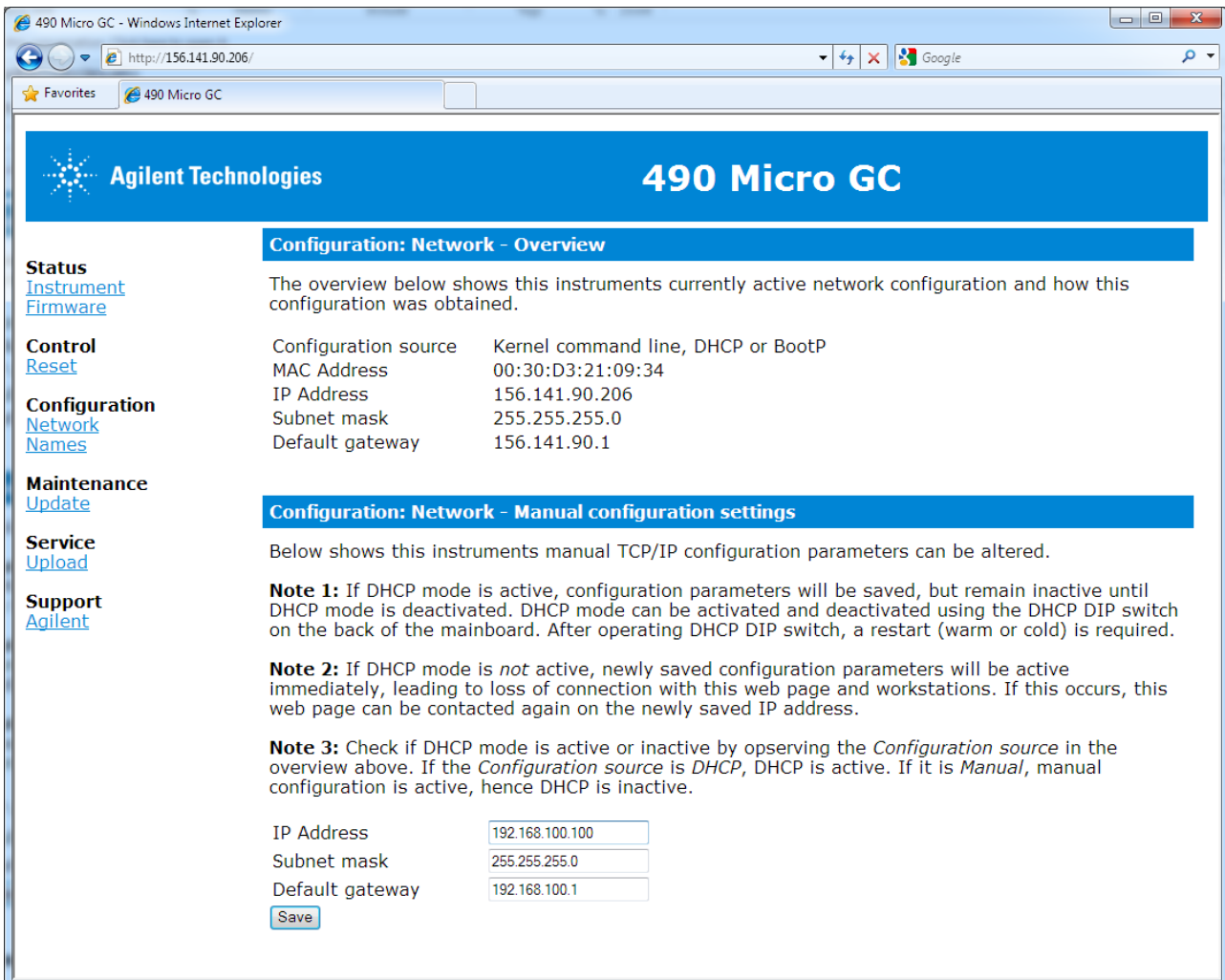

490 Micro GC - Windows Internet Explorer
 http://156.141.90.206/

Agilent Technologies **490 Micro GC**

Status
[Instrument](#)
[Firmware](#)

Control
[Reset](#)

Configuration
[Network](#)
[Names](#)

Maintenance
[Update](#)

Service
[Upload](#)

Support
[Agilent](#)

Configuration: Network - Overview

The overview below shows this instruments currently active network configuration and how this configuration was obtained.

Configuration source	Kernel command line, DHCP or BootP
MAC Address	00:30:D3:21:09:34
IP Address	156.141.90.206
Subnet mask	255.255.255.0
Default gateway	156.141.90.1

Configuration: Network - Manual configuration settings

Below shows this instruments manual TCP/IP configuration parameters can be altered.

Note 1: If DHCP mode is active, configuration parameters will be saved, but remain inactive until DHCP mode is deactivated. DHCP mode can be activated and deactivated using the DHCP DIP switch on the back of the mainboard. After operating DHCP DIP switch, a restart (warm or cold) is required.

Note 2: If DHCP mode is *not* active, newly saved configuration parameters will be active immediately, leading to loss of connection with this web page and workstations. If this occurs, this web page can be contacted again on the newly saved IP address.

Note 3: Check if DHCP mode is active or inactive by observing the *Configuration source* in the overview above. If the *Configuration source* is *DHCP*, DHCP is active. If it is *Manual*, manual configuration is active, hence DHCP is inactive.

IP Address	<input type="text" value="192.168.100.100"/>
Subnet mask	<input type="text" value="255.255.255.0"/>
Default gateway	<input type="text" value="192.168.100.1"/>

- Click **Save** to save the applied IP configuration. This IP address is now the active IP address. Communication with the Micro GC will be lost, since the active IP address has changed. To re-establish communication, type the new saved IP address in the web browser address bar, and click **Activate Communication**.

2.3 Upload of GC Configuration

In the next screen, select “Upload” to upload the configuration data of the GC to the PC.

Before upload:

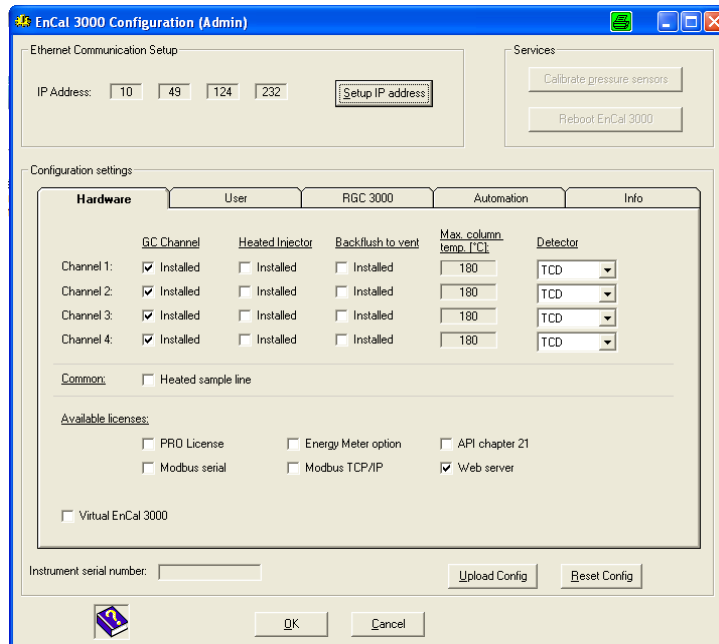

After upload:

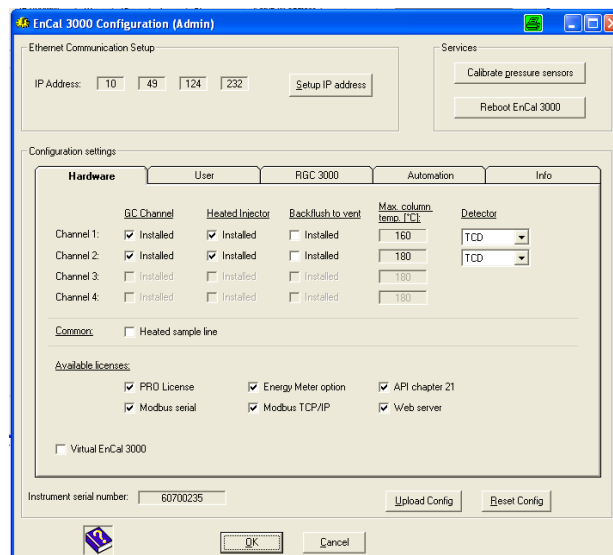

The software automatically detects the number of analytical channels are present in the device and displays this on the Hardware tab, as shown in the examples above.

Select **User**, here for each channel, the carrier gas used can be selected.

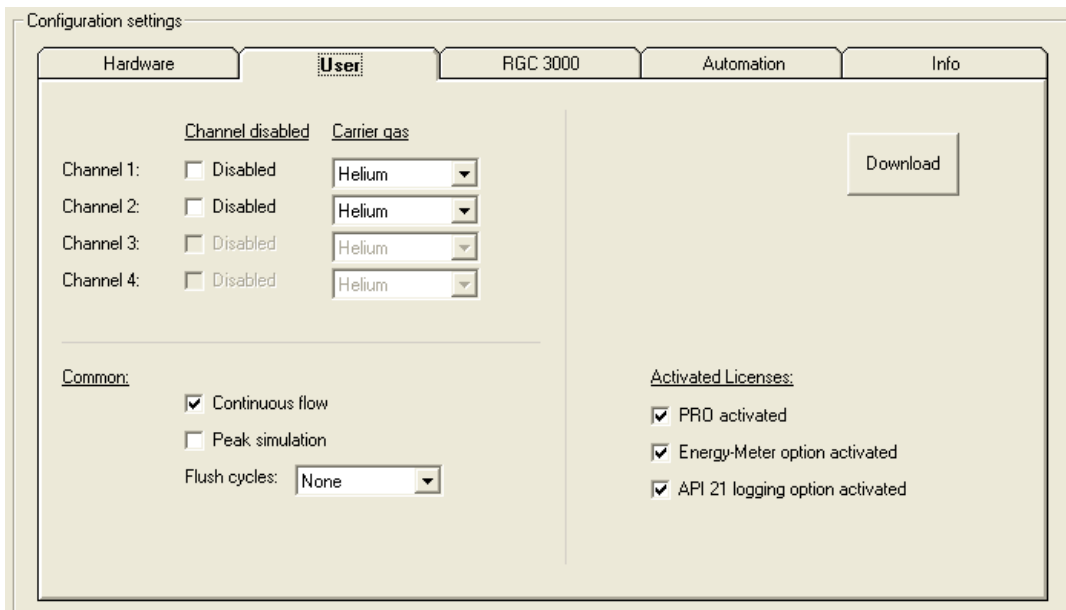

Example EnCal 3000

The number of **Flush Cycles** and the use of "continues flow" or "peak simulation" can be selected.

Typically, the device operates with **continues flow** without **peak simulation** and has the **Flush cycles** setting "**None**".

Make the settings as described and illustrated.

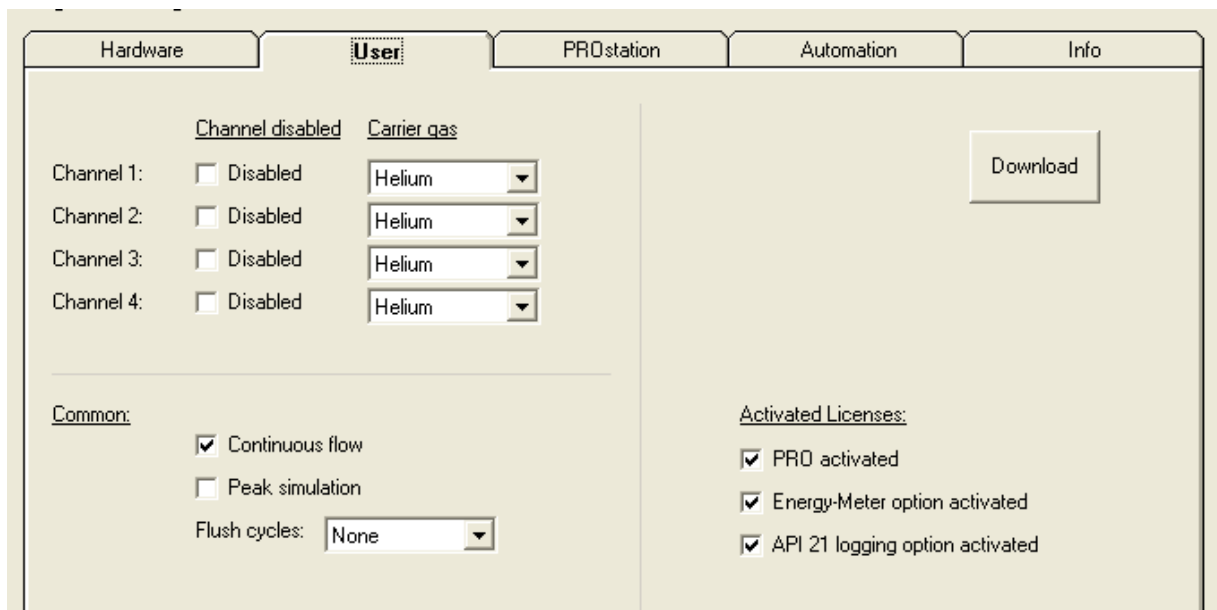

Example EnCal 3000 Quad

Then click on the **Download** button (in the same tab). In the case that the number of **Flush cycles** already is set to "**None**", no changes are necessary.

Select tab **PROstation** respectively **RGC 3000**

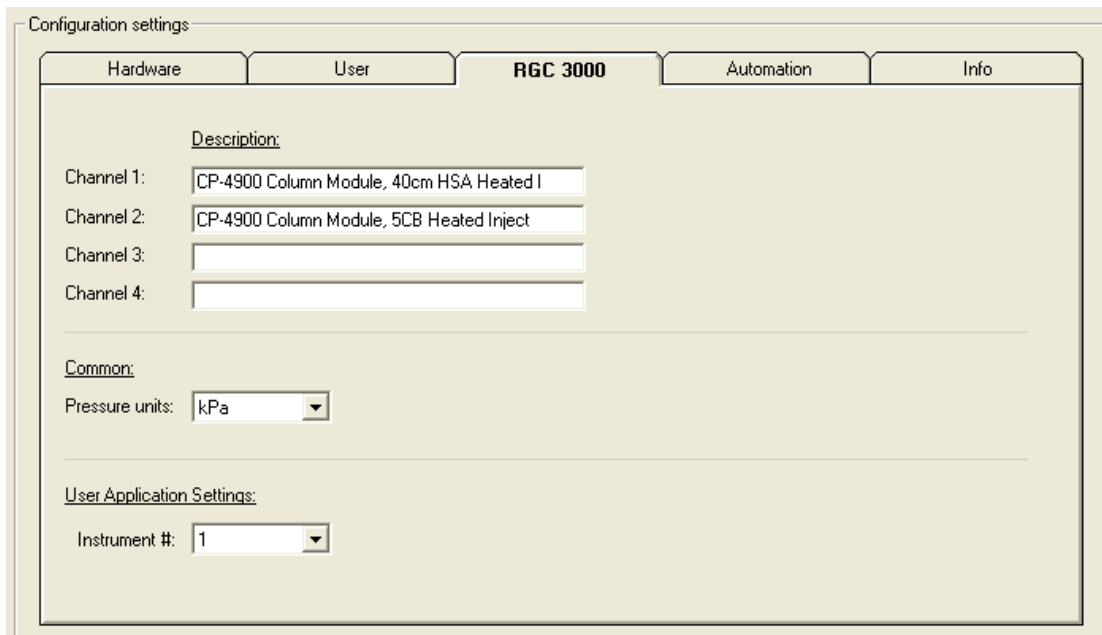

Configuration settings

Hardware User **RGC 3000** Automation Info

Description:

Channel 1: CP-4900 Column Module, 40cm HSA Heated I

Channel 2: CP-4900 Column Module, 5CB Heated Inject

Channel 3:

Channel 4:

Common:

Pressure units: kPa

User Application Settings:

Instrument #: 1

Example EnCal 3000 (2 Channels)

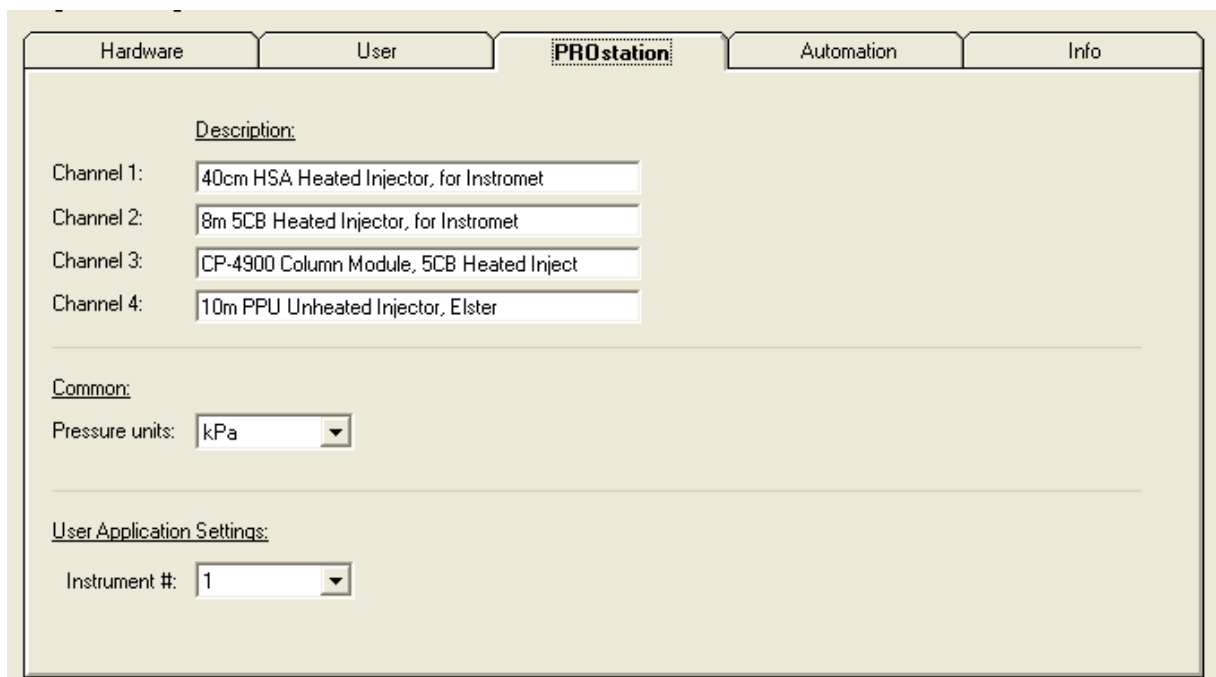

Hardware User **PROstation** Automation Info

Description:

Channel 1: 40cm HSA Heated Injector, for Instromet

Channel 2: 8m 5CB Heated Injector, for Instromet

Channel 3: CP-4900 Column Module, 5CB Heated Inject

Channel 4: 10m PPU Unheated Injector, Elster

Common:

Pressure units: kPa

User Application Settings:

Instrument #: 1

Example EnCal 3000 Quad (4 Channels)

The types of channels used / analytical columns are displayed on this page

Select tab **Automation**

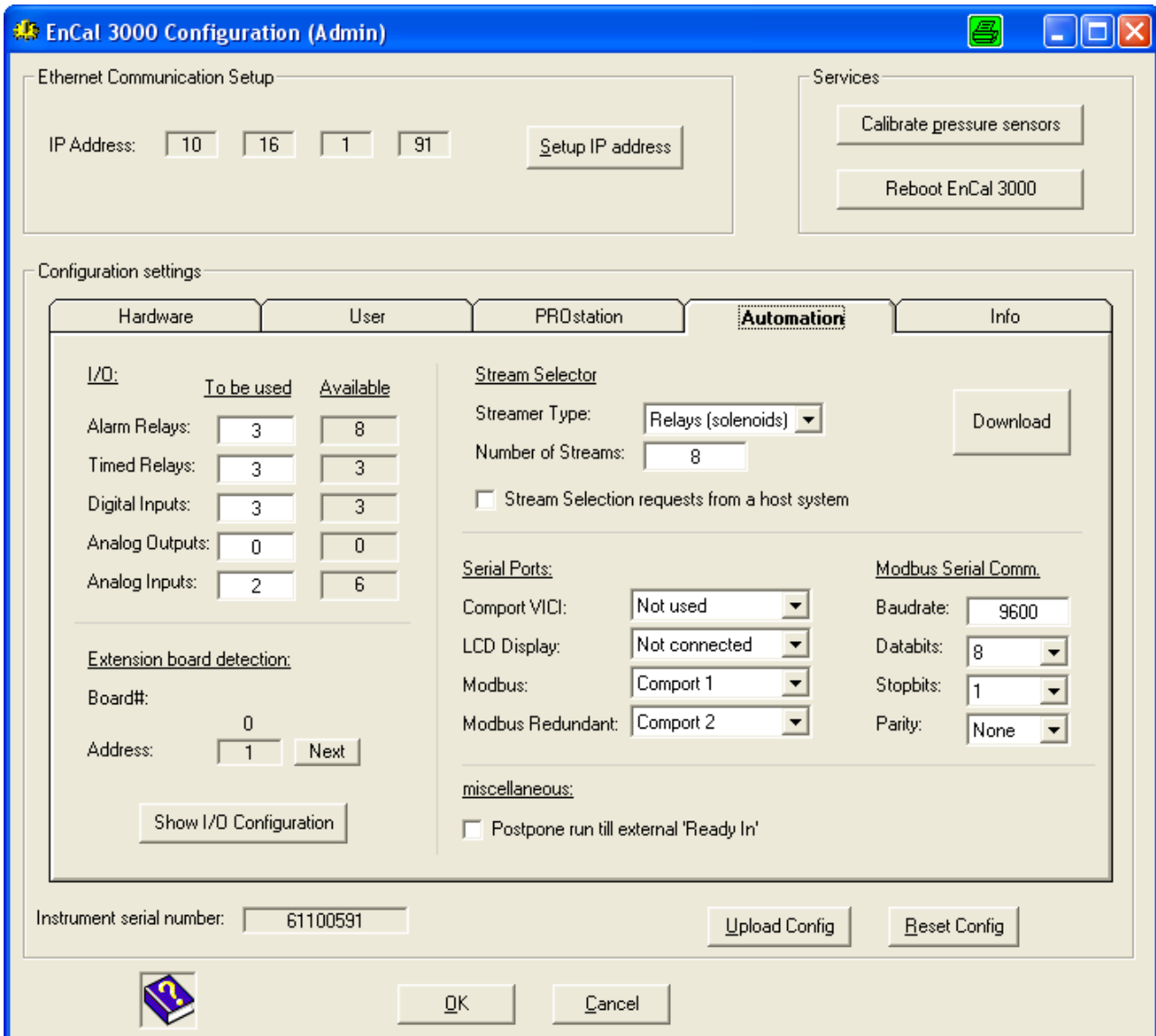

The screenshot shows the 'EnCal 3000 Configuration (Admin)' window. At the top left, the 'Ethernet Communication Setup' section contains an IP address field with the value '10.16.1.91' and a 'Setup IP address' button. To the right, the 'Services' section has 'Calibrate pressure sensors' and 'Reboot EnCal 3000' buttons. The main area is titled 'Configuration settings' and has five tabs: 'Hardware', 'User', 'PROstation', 'Automation' (which is selected), and 'Info'. Under the 'Automation' tab, there are several sections:

- I/O:** A table with columns 'To be used' and 'Available'.

	To be used	Available
Alarm Relays:	3	8
Timed Relays:	3	3
Digital Inputs:	3	3
Analog Outputs:	0	0
Analog Inputs:	2	6
- Stream Selector:** Includes a 'Streamer Type' dropdown set to 'Relays (solenoids)', a 'Number of Streams' input set to '8', and a 'Download' button. There is also a checkbox for 'Stream Selection requests from a host system' which is unchecked.
- Serial Ports:** Includes dropdowns for 'Comport VICI' (Not used), 'LCD Display' (Not connected), 'Modbus' (Comport 1), and 'Modbus Redundant' (Comport 2).
- Modbus Serial Comm.:** Includes dropdowns for 'Baudrate' (9600), 'Databits' (8), 'Stopbits' (1), and 'Parity' (None).
- miscellaneous:** Includes a checkbox for 'Postpone run till external 'Ready In'' which is unchecked.
- Extension board detection:** Includes a 'Board#' field set to '0' and an 'Address' field set to '1' with a 'Next' button. A 'Show I/O Configuration' button is also present.

 At the bottom of the configuration area, there is an 'Instrument serial number' field with the value '61100591', and 'Upload Config' and 'Reset Config' buttons. The window footer contains a help icon, 'OK', and 'Cancel' buttons.

The information on this page is independent of the number of used channels.

Select tab **Info**

Configuration settings

Hardware	User	RGC 3000	Automation	Info
<u>EnCal 3000</u>				
	Software version	Firmware I/O Ext.	Serial# Analy. I Module	Part number#
MPU:	<input type="text" value="2,20 build 22375"/>	Channel 1: <input type="text" value="1,00"/>	<input type="text" value="60156"/>	<input type="text" value="490103"/>
I/O Controller:	<input type="text" value="1,15"/>	Channel 2: <input type="text" value="1,00"/>	<input type="text" value="61113"/>	<input type="text" value="74136350"/>
		Channel 3: <input type="text" value="-"/>	<input type="text" value="-"/>	<input type="text" value="-"/>
		Channel 4: <input type="text" value="-"/>	<input type="text" value="-"/>	<input type="text" value="-"/>
<u>RGC 3000</u>				
	InstDataExchange.dll:	<input type="text" value="3,00 build 004"/>		
	Gc_dll.dll:	<input type="text" value="1,40 build 002"/>		
Instrument serial number:		<input type="text" value="61000486"/>		<input type="button" value="Upload Config"/> <input type="button" value="Reset Config"/>

Example EnCal 3000 (2 Channels)

Hardware	User	PRDstation	Automation	Info
<u>Micro-GC:</u>				
	Software version	Firmware I/O Ext.	Serial# Analy. I Module	Part number#
MPU:	<input type="text" value="2,20 build 19606"/>	Channel 1: <input type="text" value="1,00"/>	<input type="text" value="64819"/>	<input type="text" value="74136450"/>
I/O Controller:	<input type="text" value="1,15"/>	Channel 2: <input type="text" value="1,00"/>	<input type="text" value="64260"/>	<input type="text" value="74136350"/>
		Channel 3: <input type="text" value="1,00"/>	<input type="text" value="55230"/>	<input type="text" value="74136550"/>
		Channel 4: <input type="text" value="1,00"/>	<input type="text" value="62551"/>	<input type="text" value="74286150"/>
<u>PRDstation:</u>				
	InstDataExchange.dll:	<input type="text" value="2,20 build 006"/>		
	Gc_dll.dll:	<input type="text" value="1,40 build 002"/>		

Example EnCal 3000 Quad (4 Channels)

This tab shows the version number of the installed software.

In the shown example software version 2.20 build 22375 is installed with the Firmware 1.00 (on each modules of the chromatograph).

Additionally the serial number (**Serial Analy. I. Module**) and the **Part number** of the modules are shown.

The version of the RGC 3000 software (ProStation) is also specified.

Note: References in this guide addresses and version numbers are for example only.

Click on **OK** in the in the lower part of the window

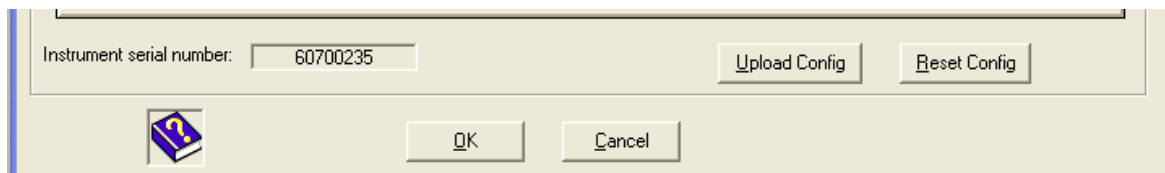

The window "**Configure Instrument**" displays the unit that is currently connected to the PC.

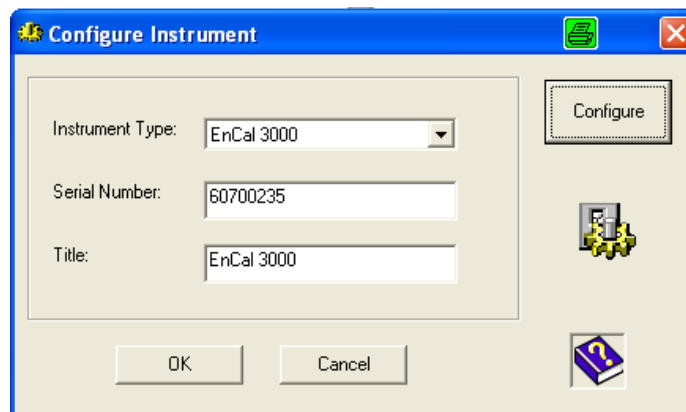

Select "**OK**" again. Than the Instrument Selection menu appears again, displaying the unit currently connected to the PC.



The software configuration of the EnCal 3000 on the PC is now ready. To install another unit on your PC, select **“New Instrument”** under **“File”**, and run through the same procedure.

3 Overview of the Main Functions

3.1 Introduction

This section gives an overview of the most important menus. Each menu will be described in detail in the following chapters. This chapter however will allow the operator to do the basic operations, and get a first feel & look of RGC3000.

3.2 Instrument 'Status'

Instrument Status (activated through menu **Control** or by selecting the corresponding icon) displays the actual status of the device

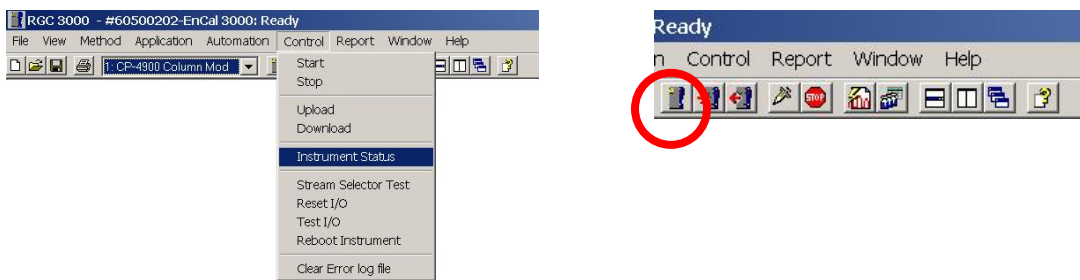

Instrument Status has typically the following appearance:

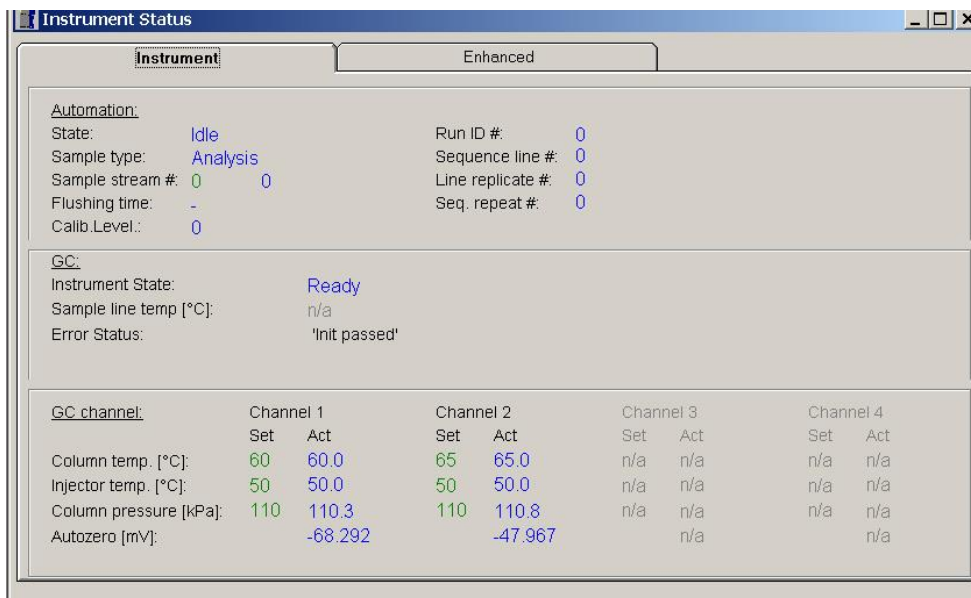

The green colour indicates the user defined set-points. Actual values are displayed in blue in case they are within the internally defined limits of the device, and in red if outside these ranges.

Status gives a first overview of the unit, and allows the user to check quickly the pressure and temperature settings. It also gives an overview of the current analysis, analysis time, current stream and next stream. It is typically the first verification of the overall analyser status.

Protection of the Parameter settings in Instrument Status

In the enhanced instruments status the cabinet temperature, -pressure, the voltage for the power supply and the method protection are visible. If the method protection is “On (Locked)” like in the following picture, it is not possible to download changed parameter settings to the device.

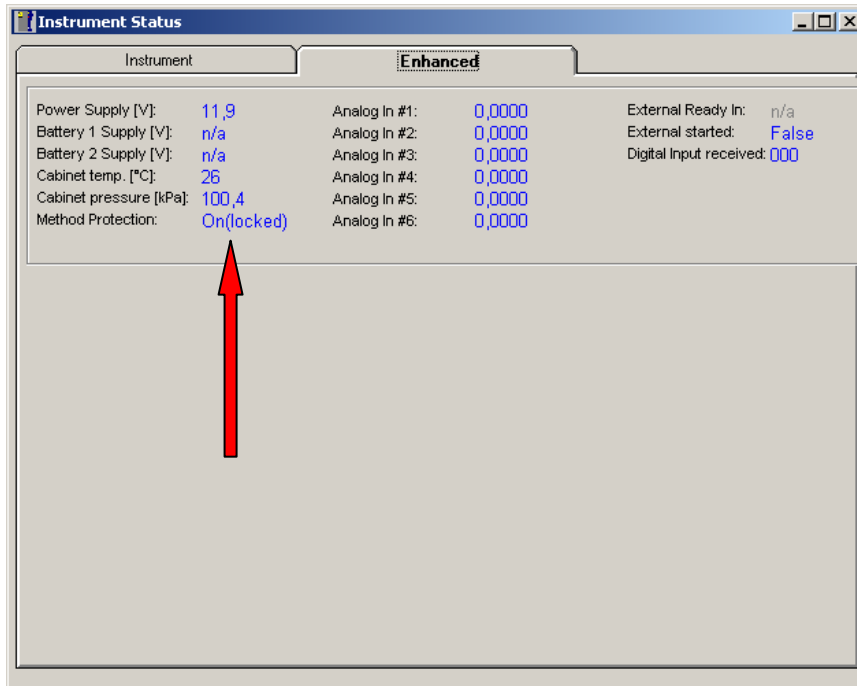

If the method protection is „Off (unlocked)“ like shown in the following picture, it is possible to download changed parameter settings like for example a changed sequence as described in chapter 3.5.

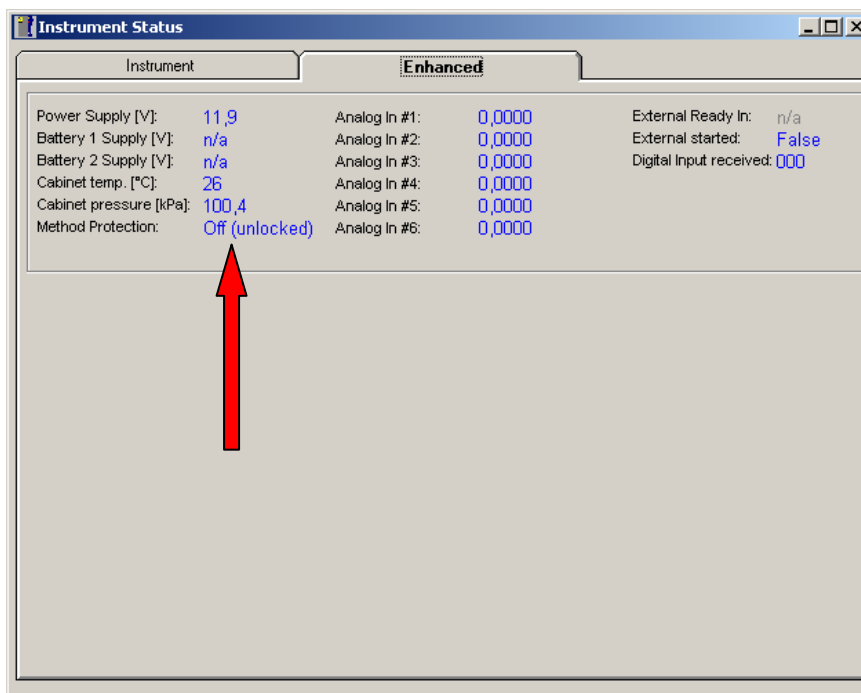

3.3 Start (Control)

Start (activated through menu **Control** or by selecting the corresponding icon) allows to start a sequence or a single analysis.

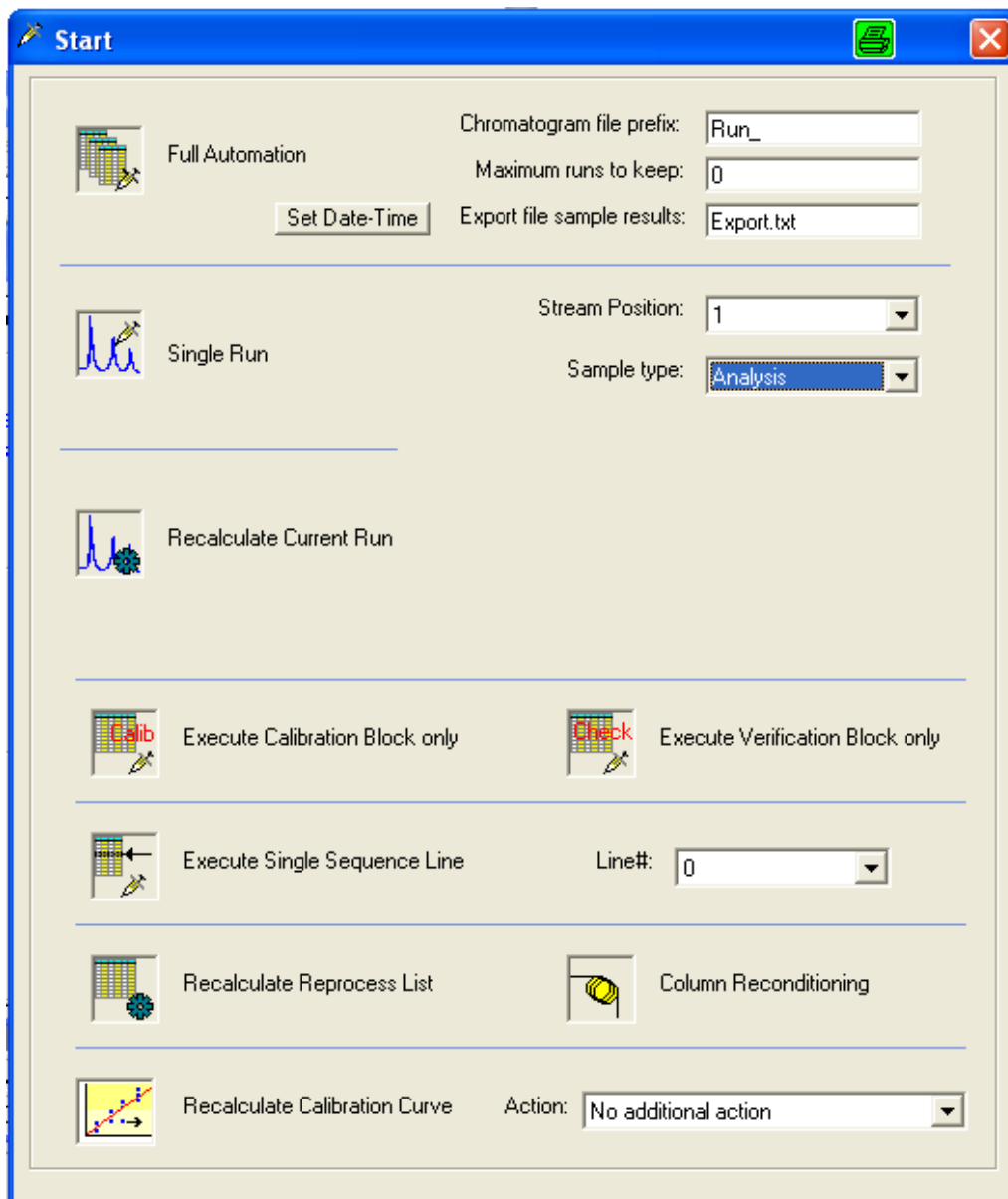
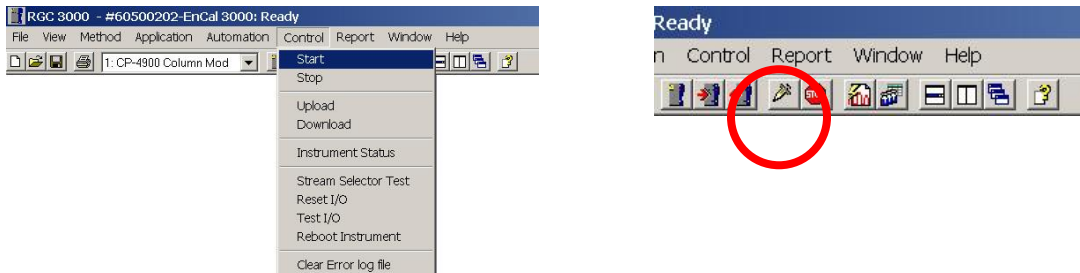

Full automation starts the analysis series that was set in the menu **Sequence** and is used for continuous analysis of a series of sample gases (for more information see Section 4.2)

Single Run starts in this example, an analysis of measurement path 1. By "**Sample type**" the options **Calibration**, **Blank** and **Verification** can also be chosen.

If a run is selected by **Single Run** and the measurement path is changed the following message will appear:

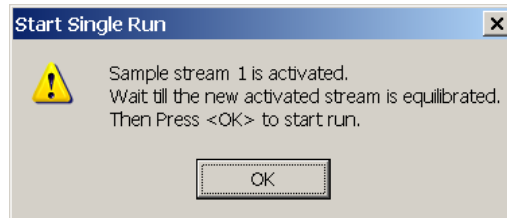

This message will remind you to wait until the newly activated measurement path is in equilibrated.

This time allows the unit to purge first the tubing with the sample gas before actually injecting into the column.

Wait **at least 60 s** to allow sufficient purging of the unit.

After this time click on **OK**, to start an analysis.

With **Execute Calibration Block only** a calibration can be started as configured in the menu "**sequence / calibration table**".

With **Execute Verification Block only** a test gas measurement can be started as configured in the menu „**sequence / verification table**“.

Make sure that the gas with the correct pressure settings is connected on the gas chromatograph

Carrier gas	5-6 barg (71-86 PSig)	Recommended pressure 5.5 barg (80 PSig)
Sample gas	1-4 barg (15-57 PSig)	
Calibration Gas	1-4 barg (15-57 PSig)	

(For more details see Encal3000_Hardware_Manual, chapter 5).

3.4 Chromatogram

Once a **Run** is started, automatically chromatograms (one per channel) will be displayed.

The chromatograms will initially appear randomly on the screen.

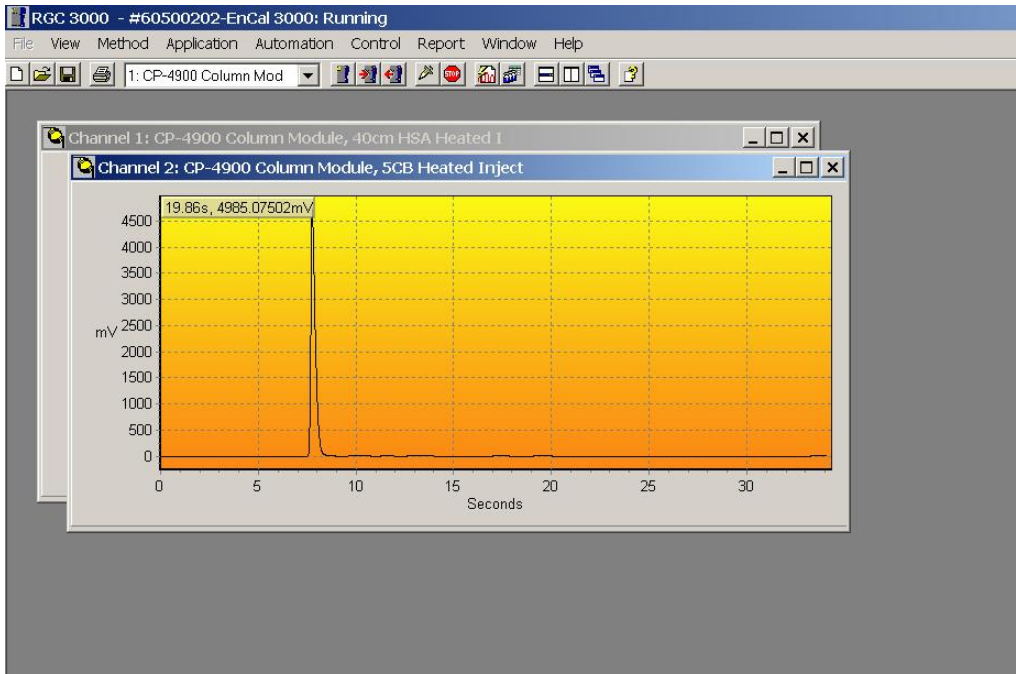

The view of a chromatogram can zoom (**ZOOM IN**), by:

- either with the right mouse button invokes the **Zoom**-Menu,
- or by raising a square. Therefore hold the left mouse button pressed and begin in the upper left above the area to be magnified.

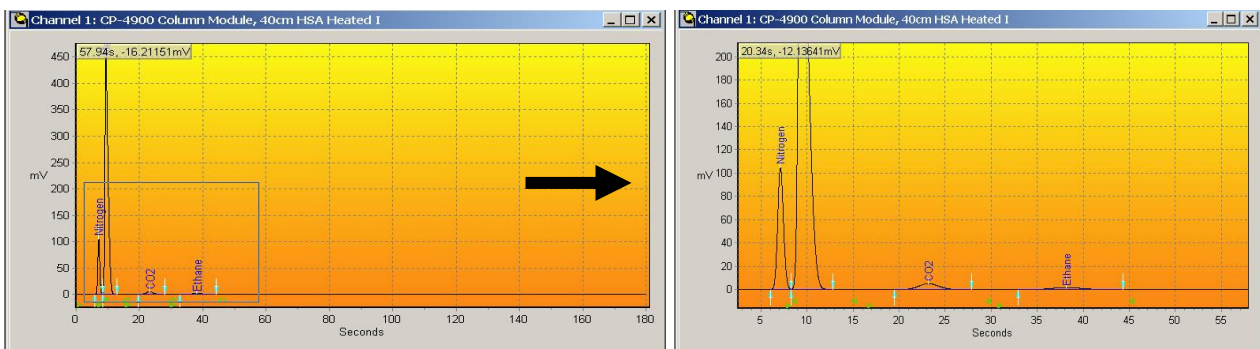

The view can be scaled with the same actions and (**ZOOM OUT**). Make sure that you start the bottom right, if you use the drag function of the mouse to display the entire chromatogram on the screen.

Select the chromatogram of channel 1 and then the Horizontal Tile button to have them equally distributed over the screen, with Channel 1 on top.

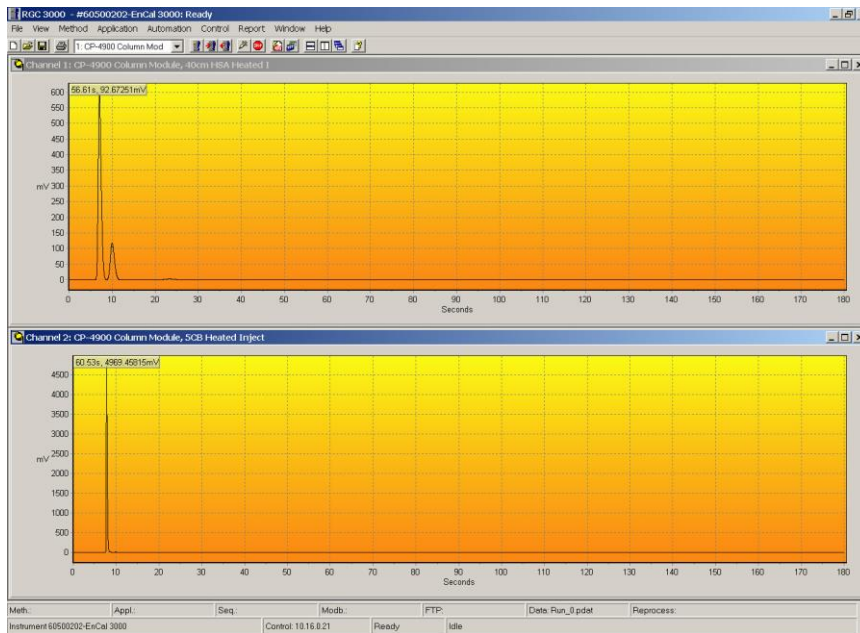
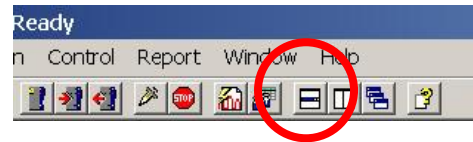
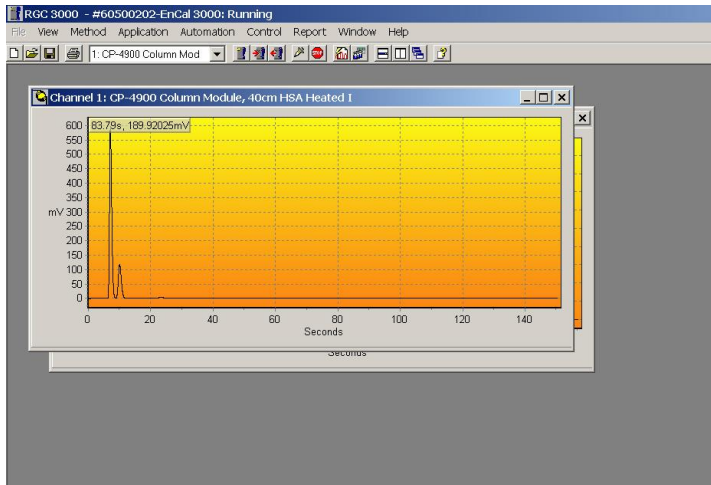

Use the menu item **Save Workspace** (to open the menu with the right mouse button click on the disk icon), this arrangement can be stored on the hard drive. Later, when you click on the menu item **User Workspace** in the View menu, this arrangement (or another custom arrangement) is retrieved and displayed.

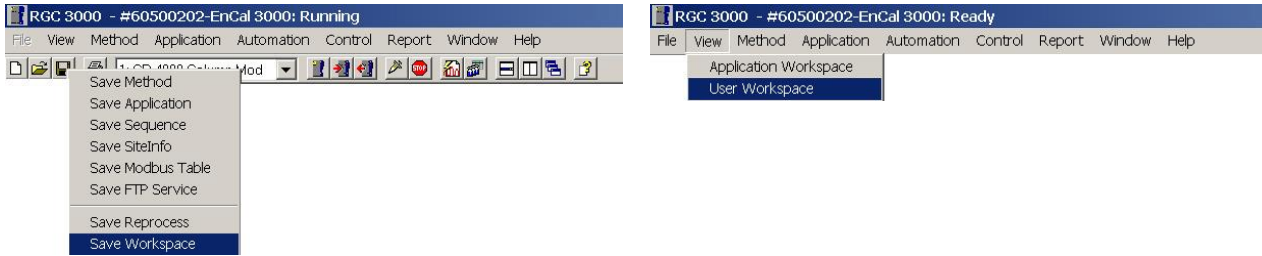

When you click the menu item **Application Workspace** in the **View** menu, the following pre-arrangement is shown on the screen.

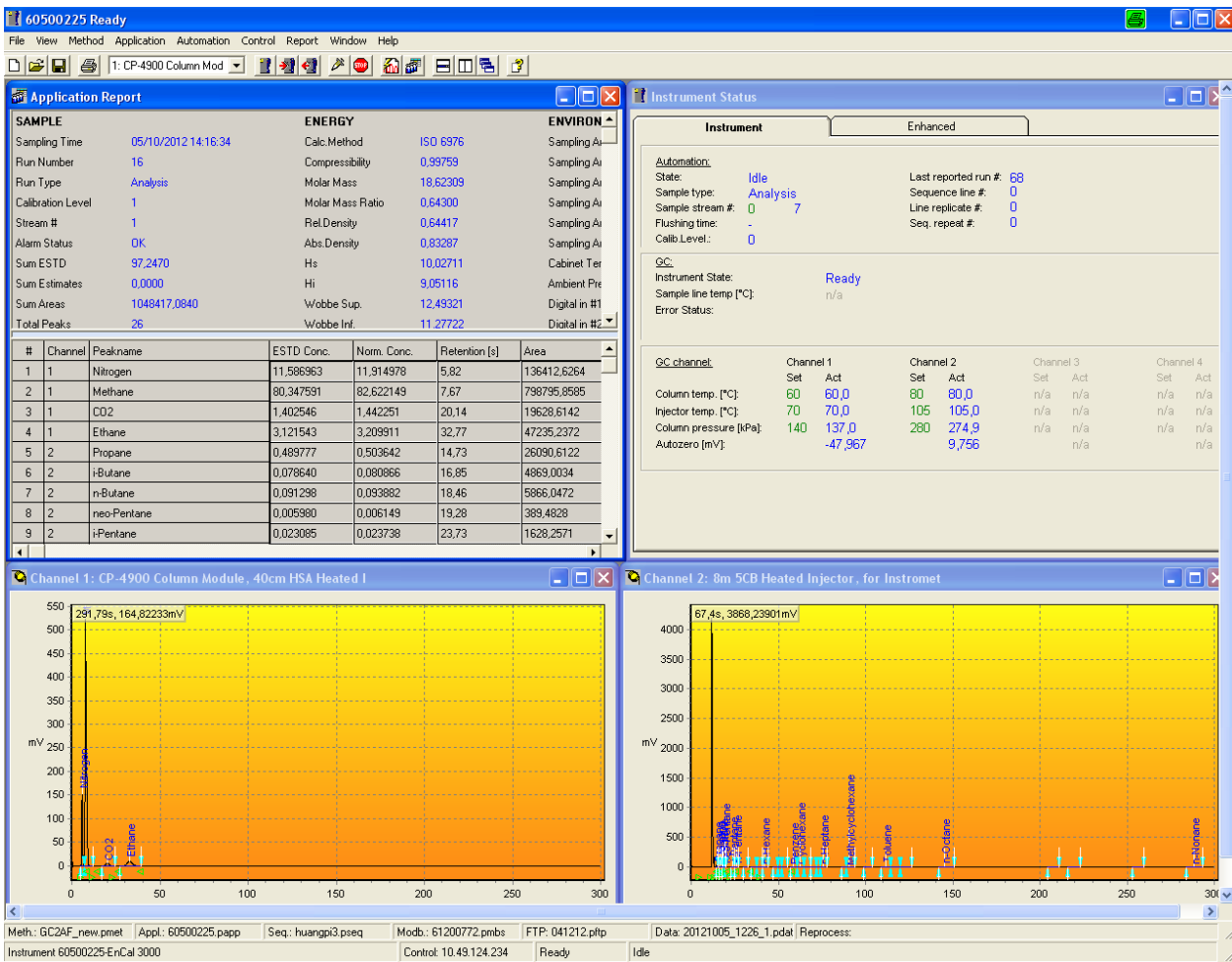

Application Report

SAMPLE		ENERGY		ENVIRON	
Sampling Time	05/10/2012 14:15:34	Calc. Method	ISO 6376	Sampling Au	
Run Number	16	Compressibility	0.93759	Sampling Au	
Run Type	Analysis	Molar Mass	18.62309	Sampling Au	
Calibration Level	1	Molar Mass Ratio	0.64300	Sampling Au	
Stream #	1	Rel. Density	0.64417	Sampling Au	
Alarm Status	OK	Abs. Density	0.83287	Sampling Au	
Sum ESTD	97.2470	Hs	10.02711	Cabinet Ter	
Sum Estimates	0.0000	Hi	9.05116	Ambient Pre	
Sum Areas	1048417.0840	Wobbe Sup.	12.49321	Digital in #1	
Total Peaks	26	Wobbe Inf.	11.27722	Digital in #2	

#	Channel	Peakname	ESTD Conc.	Norm. Conc.	Retention [s]	Area
1	1	Nitrogen	11.586963	11.914978	5.82	136412.6264
2	1	Methane	80.347591	82.622149	7.67	798795.8585
3	1	CO2	1.402546	1.442251	20.14	19628.6142
4	1	Ethane	3.121543	3.209911	32.77	47235.2372
5	2	Propane	0.489777	0.503642	14.73	26090.6122
6	2	i-Butane	0.078640	0.080866	16.85	4869.0034
7	2	n-Butane	0.091298	0.093882	18.46	5866.0472
8	2	neo-Pentane	0.005980	0.006145	19.28	389.4828
9	2	i-Pentane	0.023085	0.023738	23.73	1628.2571

Instrument Status

Automation: State: Idle Last reported run #: 68
 Sample type: Analysis Sequence line #: 0
 Sample stream #: 7 Line replicates #: 0
 Flushing time: - Seq. repeat #: 0
 Calib. Level: 0

QC: Instrument State: Ready
 Sample line temp [°C]: n/a
 Error Status:

QC channel:	Channel 1		Channel 2		Channel 3		Channel 4	
	Set	Act	Set	Act	Set	Act	Set	Act
Column temp. [°C]:	60	60.0	80	80.0	n/a	n/a	n/a	n/a
Injector temp. [°C]:	70	70.0	105	105.0	n/a	n/a	n/a	n/a
Column pressure [kPa]:	140	137.0	280	274.9	n/a	n/a	n/a	n/a
Autozero [mV]:		-47.967		9.756	n/a	n/a	n/a	n/a

Channel 1: CP-4900 Column Module, 40cm HSA Heated I

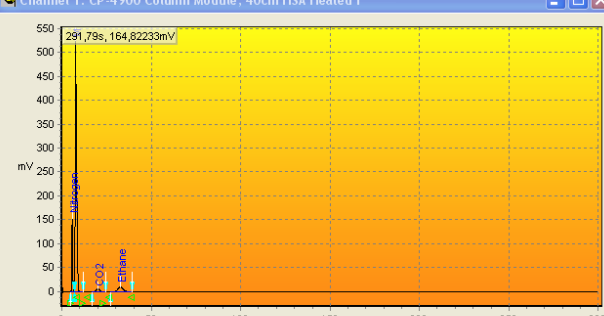

Channel 2: 8m 5CB Heated Injector, for Instrument

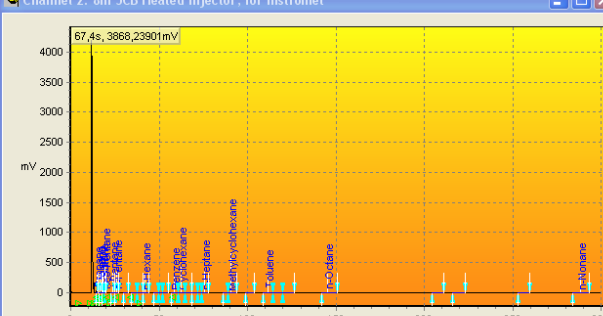

Meth.: GC2AF_new.pmet | Appl.: 60500225.papp | Seq.: huangpi3.pseq | Modb.: 61200772.pmb | FTP: 041212.pltp | Data: 20121005_1226_1.pdat | Reprocess:

Instrument 60500225-EnCal 3000 | Control: 10.49.124.234 | Ready | Idle

3.5 Upload / Download

These menu items on the **Control** menu allow the operator to import data from the gas chromatograph to the hard disk (**upload**) or modify configuration settings, and then export to the process gas chromatograph (**download**). **Caution: Concepts / direction not to be confused with the actions on the Internet.**

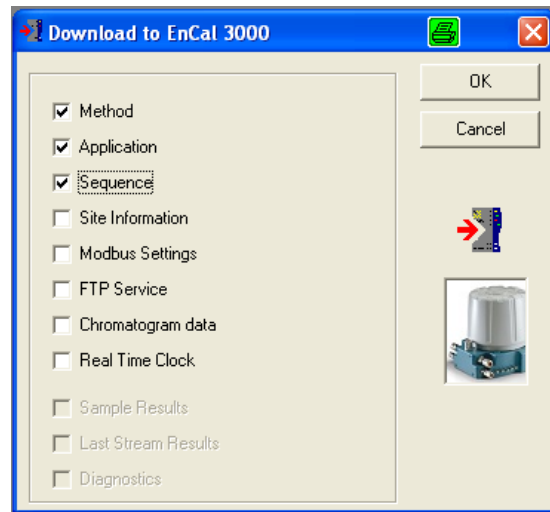
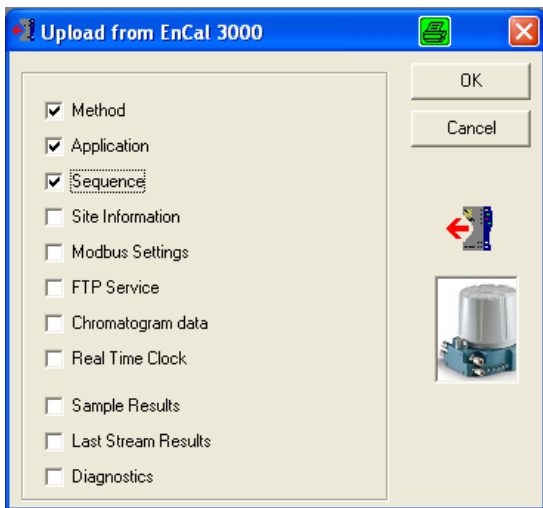
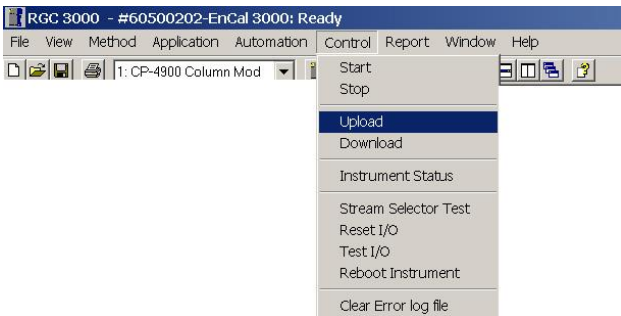

Typically, the import the configuration settings from the chromatograph to the PC part of the start-up routine. Data's are stored under **Method**, **Application**, and **Sequence**.

Once the various configuration files are imported (**upload**), they must be stored on the PC hard drive under a defined name as a backup.

By default, they are stored in the directory which is automatically created on the hard disk with the serial number of the connected unit as name.

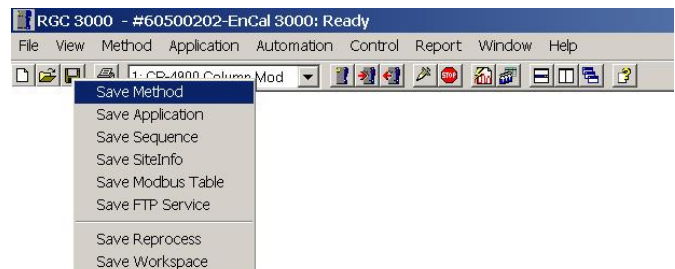
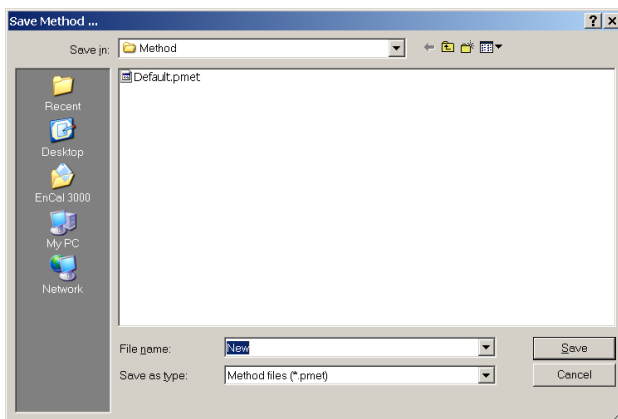

3.6 Window Instrument Setup (Menu Method)

The window **Instrument Setup** is found under menu point **Instrument Setup** in menu **Method**

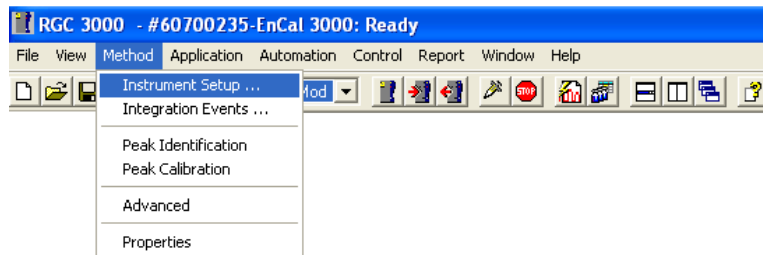

Instrument Setup allows configuration of channel temperature, head pressure, run time and other parameters. The number of tab sheets depended on the number of channels.

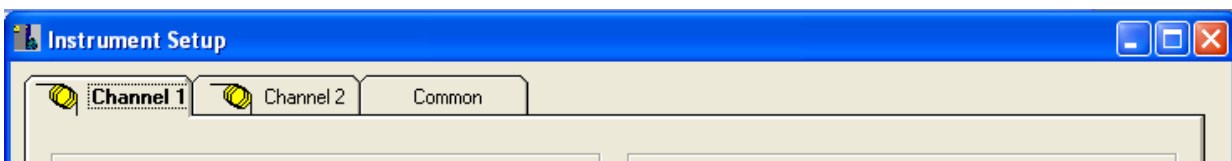

Example EnCal 3000

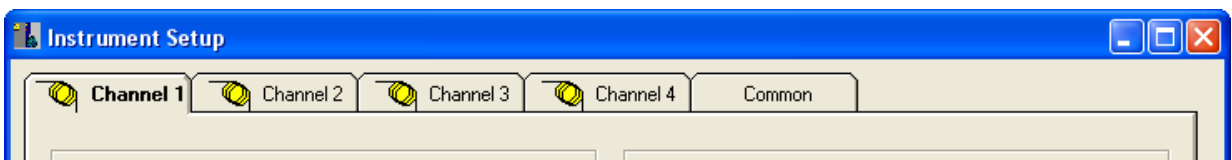

Example EnCal 3000 Quad

Tab Sheet Channel (1 – 4)

Column temperature: <input type="text" value="65"/> °C	Run time: <input type="text" value="180"/> Sec
Injector temperature: <input type="text" value="70"/> °C	
Inject time: <input type="text" value="110"/> mSec	
Backflush time: <input type="text" value="n/a"/> Sec	
Detector state: <input checked="" type="checkbox"/> On	
TCD temp. limit check: <input checked="" type="checkbox"/> On	
Sensitivity: <input type="text" value="Auto"/> <input type="checkbox"/> Invert signal	
Pressure mode: <input checked="" type="radio"/> Static <input type="radio"/> Programmed	
Initial pressure: <input type="text" value="150"/> kPa	
	Carrier Gas: <input type="text" value="Helium"/>
	Channel description: <input type="text" value="CP-4900 Column Module, 40cm HSA Heated"/>

Tab Sheet Common.

Sample time: <input type="text" value="0"/> Sec
Sample line temperature: <input type="text" value="n/a"/> °C
Stabilizing time: <input type="text" value="0"/> Sec
Continuous Flow: <input type="text" value="Enabled"/>
Flush cycles: <input type="text" value="0"/>
Peak Simulation: <input type="text" value="Disabled"/>

3.7 Window Integration events (Menu Method)

The window **Integration events** is found under menu point **Integration events** in menu **Method**

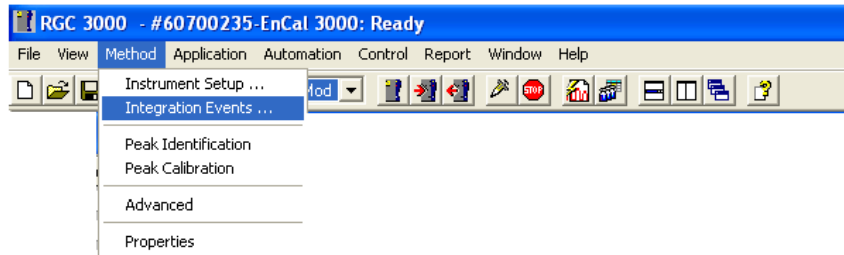

Integration events contains a list per channel of integration actions which have to be taken during the analysis. When using an EnCal 3000 Quad up to four channels are possible. The submenu is illustrated in the following chapters.

#	Active	Event ID	Start Time	Value
1	✓	14. Turn Integration Off	0	0
2	✓	10. Set Minimal Area	0	100
3	✓	1. Set Peak Width [s]	0	1,5
4	✓	2. Set Threshold [10 nV]	4,5	1
5	✓	13. Turn Integration On	5	0
6	✓	3. Double Peak Width Now	15	0
7	✓	2. Set Threshold [10 nV]	15	1
8	✓	2. Set Threshold [10 nV]	28,5	0,5
9	✓	14. Turn Integration Off	60	0

#	Active	Event ID	Start Time	Value
1	✓	14. Turn Integration Off	0	0
2	✓	1. Set Peak Width [s]	0	0,5
3	✓	10. Set Minimal Area	0	5
4	✓	13. Turn Integration On	14	0
5	✓	22. Baseline Valley To Valley On	14	0
6	✓	2. Set Threshold [10 nV]	14	1,5
7	✓	23. Baseline Valley To Valley Off	15,8	0
8	✓	2. Set Threshold [10 nV]	15,8	1,5
9	✓	3. Double Peak Width Now	17,73	0
10	✓	2. Set Threshold [10 nV]	17,73	0,05
11	✓	2. Set Threshold [10 nV]	30	0,05
12	✓	1. Set Peak Width [s]	45	3
13	✓	2. Set Threshold [10 nV]	45	0,01
14	✓	2. Set Threshold [10 nV]	127	0,007
15	✓	1. Set Peak Width [s]	275	5
16	✓	14. Turn Integration Off	300	0

#	Active	Event ID	Start Time	Value
1	✓	14. Turn Integration Off	0	0
2	✓	10. Set Minimal Area	0	5
3	✓	1. Set Peak Width [s]	0	1
4	✓	2. Set Threshold [10 nV]	4	1
5	✓	13. Turn Integration On	4	0
6	✓	3. Double Peak Width Now	15	0
7	✓	2. Set Threshold [10 nV]	18	0,05
8	✓	22. Baseline Valley To Valley On	18	0
9	✓	2. Set Threshold [10 nV]	33	0,02
10	✓	23. Baseline Valley To Valley Off	40	0
11	✓	1. Set Peak Width [s]	61	3
12	✓	2. Set Threshold [10 nV]	61	0,01
13	✓	22. Baseline Valley To Valley On	61	0
14	✓	2. Set Threshold [10 nV]	105	0,007
15	✓	1. Set Peak Width [s]	105	5
16	✓	2. Set Threshold [10 nV]	117	0,01
17	✓	14. Turn Integration Off	180	0

#	Active	Event ID	Start Time	Value
1	✓	14. Turn Integration Off	0	0
2	✓	1. Set Peak Width [s]	0	0,5
3	✓	10. Set Minimal Area	0	10
4	✓	13. Turn Integration On	15	0
5	✓	22. Baseline Valley To Valley On	22	0
6	✓	2. Set Threshold [10 nV]	15	1
7	✓	23. Baseline Valley To Valley Off	35	0
8	✓	2. Set Threshold [10 nV]	35	0,01
9	✓	22. Baseline Valley To Valley On	40	0
10	✓	1. Set Peak Width [s]	40	2
11	✓	1. Set Peak Width [s]	47	1
12	✓	2. Set Threshold [10 nV]	55	0,5
13	✓	1. Set Peak Width [s]	60	3
14	✓	1. Set Peak Width [s]	155	25
15	✓	14. Turn Integration Off	300	0

3.8 Window Peak Identification (Menu Method)

The window **Peak Identification** is found under menu point **Peak Identification** in menu **Method**

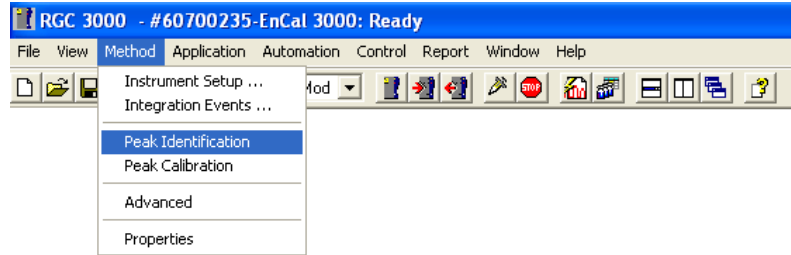

Peak Identification contains a list of peak parameters (retention time, cal gas concentration, response factor etc.) for each of the four possible channels. The submenu is illustrated in the following chapters.

#	Active	Peak Name	ID	Ret.Time	Rel.Ret.Window	Abs.Ret.Window	Reference	Selection Mode	Rel.Ret.Peak	Level 1	Level 2	Level 3	Level 4
1	<input checked="" type="checkbox"/>	Nitrogen	1	6.067021	5	5		0. Nearest		4.02	0	0	0
2	<input checked="" type="checkbox"/>	Methane	2	7.584883	5	5		0. Nearest		88,80353	0	0	0
3	<input checked="" type="checkbox"/>	CO2	3	20.38294	5	5		0. Nearest		1.51	0	0	0
4	<input checked="" type="checkbox"/>	Ethane	4	33.36982	5	5		0. Nearest		4.02	0	0	0

#	Active	Peak Name	ID	Ret.Time	Rel.Ret.Window	Abs.Ret.Window	Reference	Selection Mode	Rel.Ret.Peak	Level 1	Level 2	Level 3	Level 4
1	<input checked="" type="checkbox"/>	Propane	1	15.3675	5	5		0. Nearest		1.01	0	0	0
2	<input checked="" type="checkbox"/>	i-Butane	2	17.5	5	5		0. Nearest		0.201	0	0	0
3	<input checked="" type="checkbox"/>	n-Butane	3	19.0925	5	5		0. Nearest		0.202	0	0	0
4	<input checked="" type="checkbox"/>	neo-Pentane	4	19.9175	5	5		0. Nearest		0.05	0	0	0
5	<input checked="" type="checkbox"/>	i-Pentane	5	24.305	5	5		0. Nearest		0.051	0	0	0
6	<input checked="" type="checkbox"/>	n-Pentane	6	26.68	5	5		0. Nearest		0.05	0	0	0
7	<input checked="" type="checkbox"/>	n-Hexane	7	42.305	5	5		0. Nearest		0.051	0	0	0
8	<input checked="" type="checkbox"/>	n-Heptane	8	74.355	5	5		0. Nearest		0.021	0	0	0
9	<input checked="" type="checkbox"/>	n-Octane	9	139.63	5	5		0. Nearest		0.0073	0	0	0
10	<input checked="" type="checkbox"/>	n-Nonane	10	272.1275	5	5		0. Nearest		0.0021	0	0	0

#	Active	Peak Name	ID	Ret.Time	Rel.Ret.Window	Abs.Ret.Window	Reference	Selection Mode	Rel.Ret.Peak	Level 1	Level 2	Level 3	Level 4
1	<input checked="" type="checkbox"/>	n-C8	1	13.64	5	5		0. Nearest		0.0073	0	0	0
2	<input checked="" type="checkbox"/>	n-C9	2	21.8425	5	5		0. Nearest		0.0021	0	0	0
3	<input checked="" type="checkbox"/>	n-Decane	3	36.3975	5	5		0. Nearest		0.00106	0	0	0
4	<input checked="" type="checkbox"/>	n-Undecane	4	63.37	5	5		0. Nearest		0	0	0	0
5	<input checked="" type="checkbox"/>	n-Dodecane	5	110.9	5	5		0. Nearest		0	0	0	0

#	Active	Peak Name	ID	Ret.Time	Rel.Ret.Window	Abs.Ret.Window	Reference	Selection Mode	Rel.Ret.Peak	Level 1	Level 2	Level 3	Level 4
1	<input checked="" type="checkbox"/>	C2H6	1	26.375	5	5		0. Nearest		4.02	0	0	0
2	<input checked="" type="checkbox"/>	H2S	2	44.88	5	5		0. Nearest		0	0	0	0
3	<input checked="" type="checkbox"/>	CO2	3	52.5	5	5		0. Nearest		0	0	0	0
4	<input checked="" type="checkbox"/>	C3H8	4	60.7225	5	5		0. Nearest		1.01	0	0	0

3.9 Window Peak Calibration (Menu Method)

The window **Peak Calibration** is found under menu point **Peak Calibration** in menu **Method**

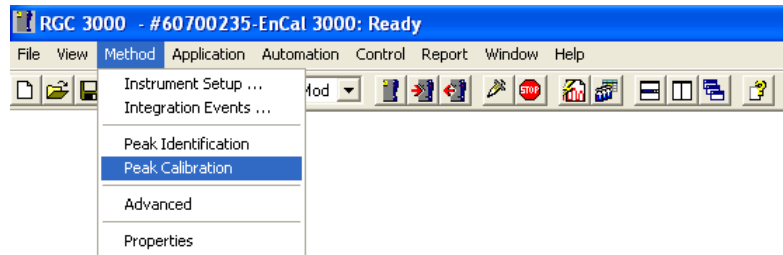

Peak Calibration contains calibration settings and results for each channel. The submenu is illustrated in the following chapters.

Review Peak Calibration: Channel 1

Calibration Settings

Response Mode: <input type="text" value="Area"/> Calibration Mode: <input type="text" value="External Standard"/> R.F. Type: <input type="text" value="Manual and Curve"/> Retention Update%: <input type="text" value="50"/> RF Unknown peaks: <input type="radio"/> Abs. <input checked="" type="radio"/> Rel.	<p><u>Channel Independent Settings:</u></p> Total Calibration Levels.: <input type="text" value="1"/> Calibration Check: <input checked="" type="checkbox"/> Initial Calibration: <input type="checkbox"/> Use GOST Calibration: <input type="checkbox"/> Retention Window Update: <input type="text" value="1. Calibration"/> Download Calibration Curve with method: <input type="checkbox"/>
--	--

Calibration Results

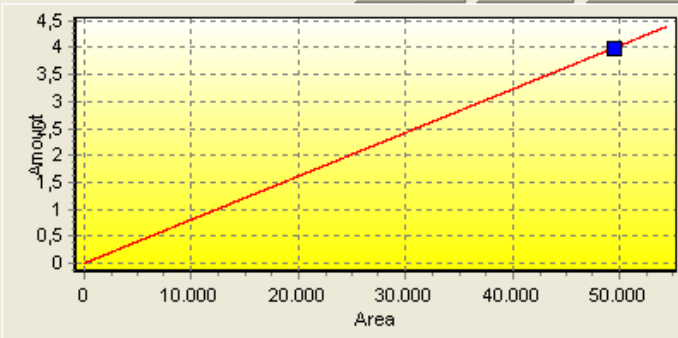
Nitrogen Methane CO2 Ethane	
--------------------------------------	--

Sample	Level 1 Area (Amount)
1	49513.811069 (3.996900)

3.10 Window Advanced Settings (Menu Method)

The window **Advanced Settings** is found under menu point **Advanced** in menu **Method**

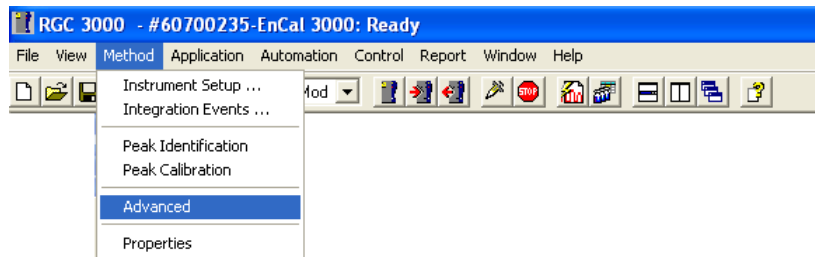

If reports are to be created on the hard disk, you must define the parameters to be saved in this screen. Activate **Export enabled** and select the parameters to be stored on the hard drive, with the help of the black arrows. For each run, a line is added to the export file. The export file name is entered in **Start** screen (**Export file sample results**) under menu **Control**.

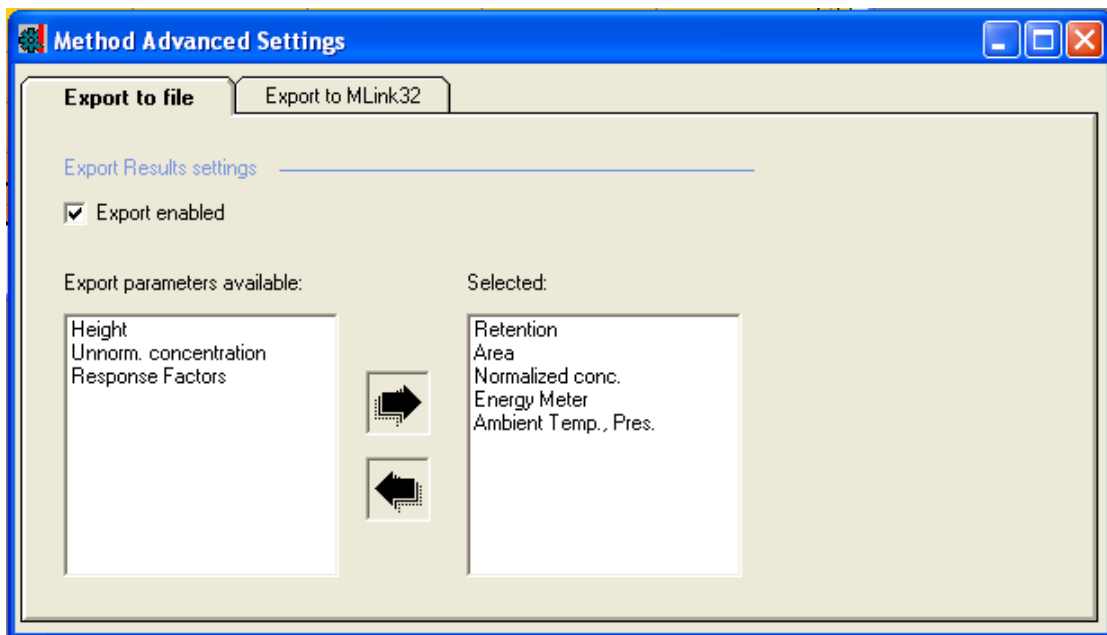

(Note: MLink 32, an Excel workbook can be used for the establishment of additional calculations during instruments acceptance phase. Settings are not changed.)

3.11 Window Method Properties (Menu Method)

The window **Method Properties** is found under menu point **Properties** in menu **Method**

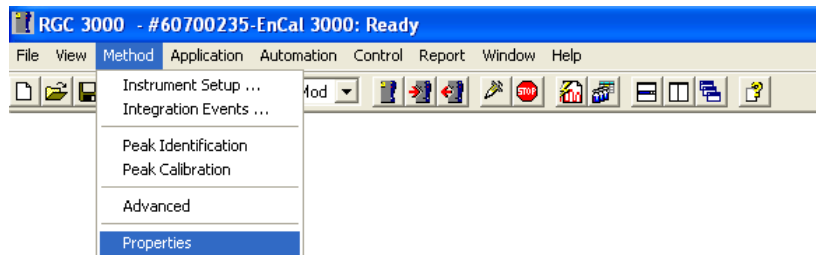

In the window **Method Properties** is defined what is to be executed after a run.

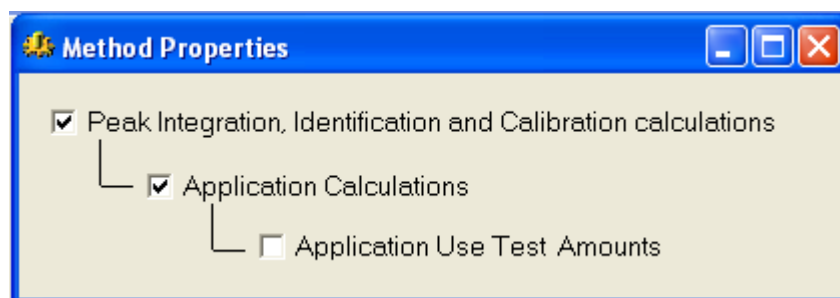

If „**Peak integration, Identification and Calibration calculations**“ is disabled, all runs are performed without calculations.

If only the top option is selected, only the data of a run become integrated. The identification of the peaks and the concentration calculations is carried out and the "**Integration Report**" shown

„**Application Calculations**“ can only be activated if the first option is checked. Calculations are carried out and controlled by input / output signals. The results are entered in the "**Application Report**".

The last option can be selected only if the above were elected. Calculations are performed using test sets instead of the actual calculated quantities.

3.12 Normalize and Calorific Power (Menu Application)

The table **Normalize** is found under menu point **Normalize** in menu **Application**

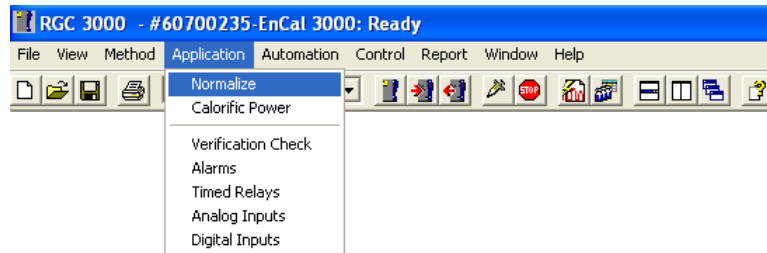

The **Application** menu includes three sections calculation information, alarms and relays. Calculation information that should be carried out with regard to the component analysis according to customer specification, either ISO, GPA, ASTM or GOST, are distributed to the tables **Normalize** and **Calorific Power**.

Table **Normalize** contains a list of available components, with channel location, estimated concentration and other parameters.

#	Active	Peak Name	Channel	Ignore	Bridge Comp #	Estimate	Estim.Conc	Test.Conc	RefConcPeak#	RefPeakConc%	Group#
1	✓	Nitrogen	1		0. None	✓	0	0	0	0	0
2	✓	Methane	1		0. None	✓	0	0	0	0	0
3	✓	CO2	1		0. None	✓	0	0	0	0	0
4	✓	Ethane	1		0. None	✓	0	0	0	0	0
5	✓	Propane	2		0. None	✓	0	0	0	0	0
6	✓	i-Butane	2		0. None	✓	0	0	0	0	0
7	✓	n-Butane	2		0. None	✓	0	0	0	0	0
8	✓	neo-Pentane	2		0. None	✓	0	0	0	0	0
9	✓	i-Pentane	2		0. None	✓	0	0	0	0	0
10	✓	n-Pentane	2		0. None	✓	0	0	0	0	0
11	✓	n-Hexane	2		0. None	✓	0	0	0	0	0
12	✓	n-Heptane	2		0. None	✓	0	0	0	0	0
13	✓	n-Octane	2		0. None	✓	0	0	0	0	0
14	✓	n-Nonane	2		0. None	✓	0	0	0	0	0
15	✓	n-Decane	2		0. None	✓	0	0	0	0	0
16	✓	Benzene	2		0. None	✓	0	0	0	0	0
17	✓	Cyclohexane	2		0. None	✓	0	0	0	0	0
18	✓	Methylcyclohexane	2		0. None	✓	0	0	0	0	0
19	✓	Toluene	2		0. None	✓	0	0	0	0	0
20	✓	n-Undecane	2		0. None	✓	0	0	0	0	0
21	✓	n-Dodecane	2		0. None	✓	0	0	0	0	0
22	✓	H2S	2		0. None	✓	0	0	0	0	0
23	✓	COs	2		0. None	✓	0	0	0	0	0
24	✓	Oxygen	2		0. None	✓	0	0	0	0	0
25	✓	Hydrogen	2		0. None	✓	0	0	0	0	0
26	✓	Helium	2		0. None	✓	0	0	0	0	0

The table **Calorific Power** is accessed via the menu item **Calorific Power** in the **Application** menu and includes a menu of choices for the type of calculation method, the standard conditions and the type of peak grouping, and a table of calorific values, density values and compressibility (if applicable) for each component, which is selected in the **Peak Identification** menu.

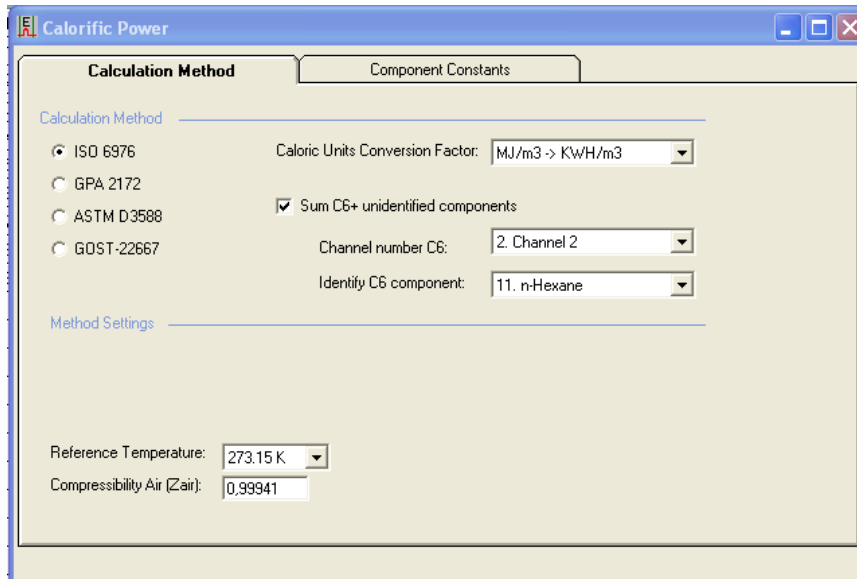
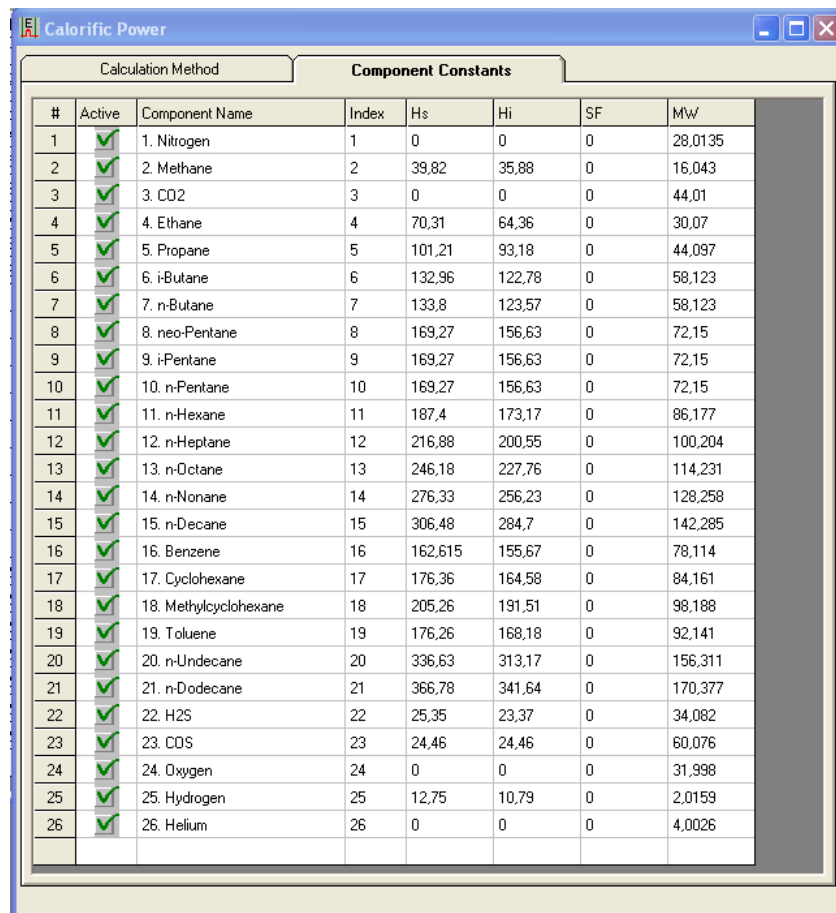
#	Active	Component Name	Index	Hs	Hi	SF	MW
1	✓	1. Nitrogen	1	0	0	0	28,0135
2	✓	2. Methane	2	39,82	35,88	0	16,043
3	✓	3. CO2	3	0	0	0	44,01
4	✓	4. Ethane	4	70,31	64,36	0	30,07
5	✓	5. Propane	5	101,21	93,18	0	44,097
6	✓	6. i-Butane	6	132,96	122,78	0	58,123
7	✓	7. n-Butane	7	133,8	123,57	0	58,123
8	✓	8. neo-Pentane	8	169,27	156,63	0	72,15
9	✓	9. i-Pentane	9	169,27	156,63	0	72,15
10	✓	10. n-Pentane	10	169,27	156,63	0	72,15
11	✓	11. n-Hexane	11	187,4	173,17	0	86,177
12	✓	12. n-Heptane	12	216,88	200,55	0	100,204
13	✓	13. n-Octane	13	246,18	227,76	0	114,231
14	✓	14. n-Nonane	14	276,33	256,23	0	128,258
15	✓	15. n-Decane	15	306,48	284,7	0	142,285
16	✓	16. Benzene	16	162,615	155,67	0	78,114
17	✓	17. Cyclohexane	17	176,36	164,58	0	84,161
18	✓	18. Methylcyclohexane	18	205,26	191,51	0	98,188
19	✓	19. Toluene	19	176,26	168,18	0	92,141
20	✓	20. n-Undecane	20	336,63	313,17	0	156,311
21	✓	21. n-Dodecane	21	366,78	341,64	0	170,377
22	✓	22. H2S	22	25,35	23,37	0	34,082
23	✓	23. COS	23	24,46	24,46	0	60,076
24	✓	24. Oxygen	24	0	0	0	31,998
25	✓	25. Hydrogen	25	12,75	10,79	0	2,0159
26	✓	26. Helium	26	0	0	0	4,0026

3.13 Verification Check and Alarms (Menu Application)

Verification Check screen is found under menu point **Verification Check** in menu **Application**

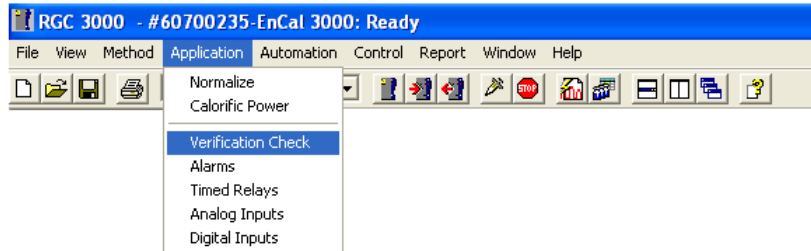

The **Application** menu includes three sections calculation information, alarms and relays. The alarm section contains menu points **Verification Check** and **Alarms**. The window **Verification Check** consists of two tabs and set the parameter limits for the verification.

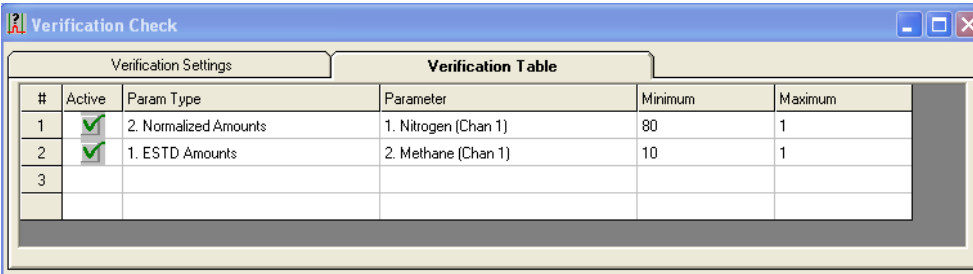
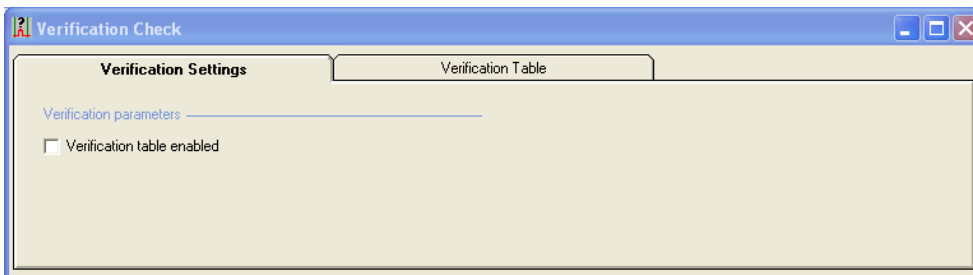

Window **Alarms** screen is found under menu point **Alarms** in menu **Application**. It consists of two tabs and set the parameter limits for the normal operation.

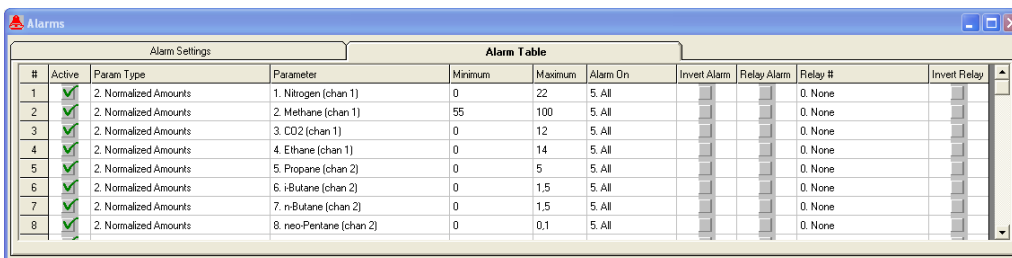
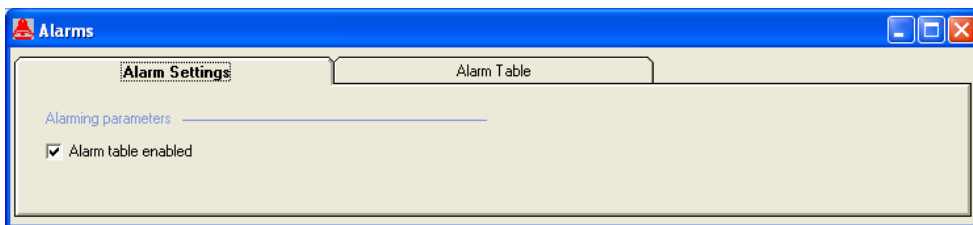

3.14 Relays (Menu Application)

The **Application** menu includes three sections calculation information, alarms and relays. In the area there are relays the following tables:



Called up by menu point **Timed Relays** in **Application** menu:

#	Event	Delay [s]	Timed Relay	Relay State

Additional to **Timed Relays** the user can define **Alarm Relays** (see chapter 4.7)

Called up by menu point **Analog Inputs** in **Application** menu:

Channel	Gain	Offset
1	4,41099353734102E-302	4,61864415153757E-62
2	2,88299965706367E-144	3,23790861658519E-319

Called up by menu point **Digital Inputs** in **Application** menu:

Digital Input	Function
Digital Input 1	0. None
Digital Input 2	0. None
Digital Input 3	0. None

3.15 Sequence (Menu Automation)

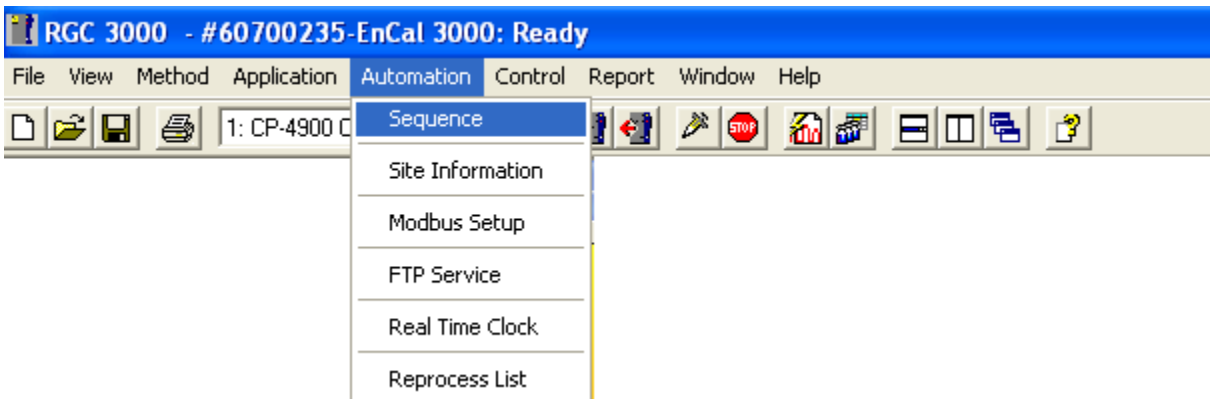

The window **Sequence** determines the order of the sample gases and the calibration frequency. The sub-menu is illustrated in the following chapters.

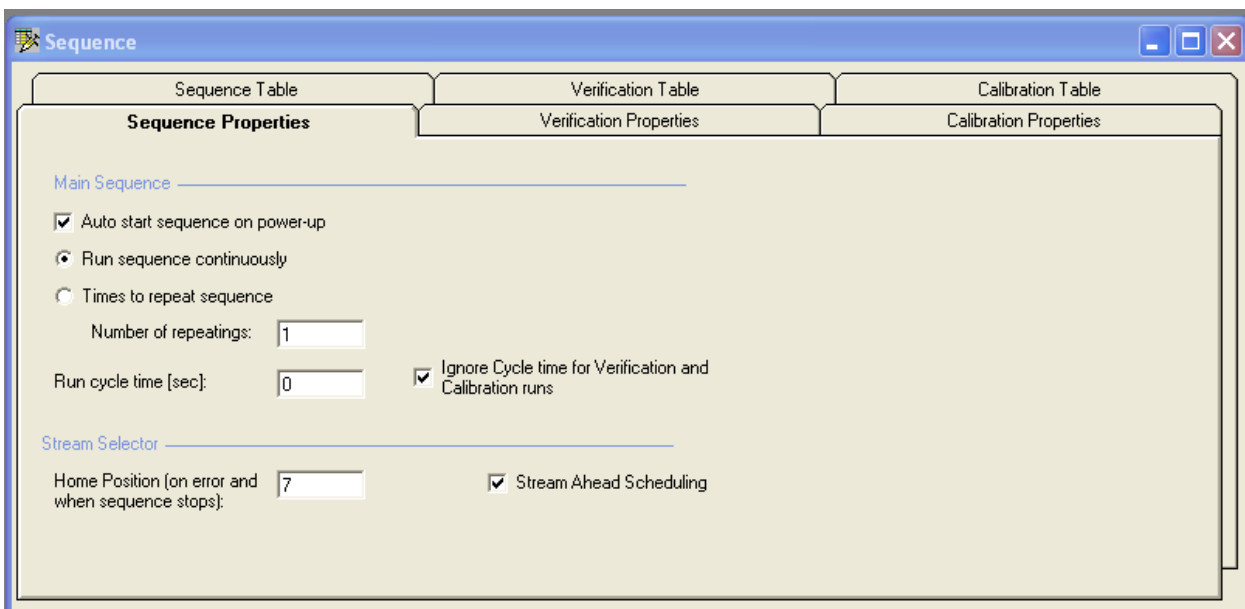

3.16 Modbus Setup (Menu Automation)

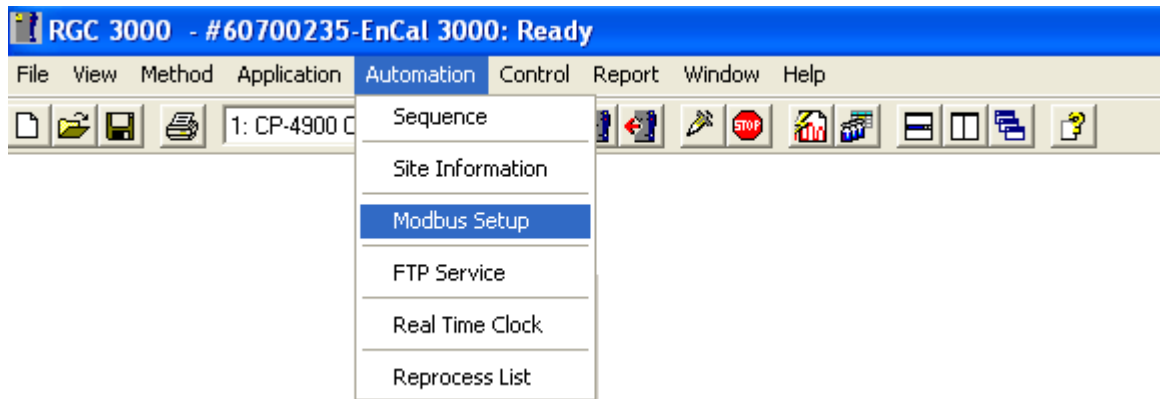

Modbus Setup allows configuration of Modbus parameters. The submenu is illustrated in the following chapters.

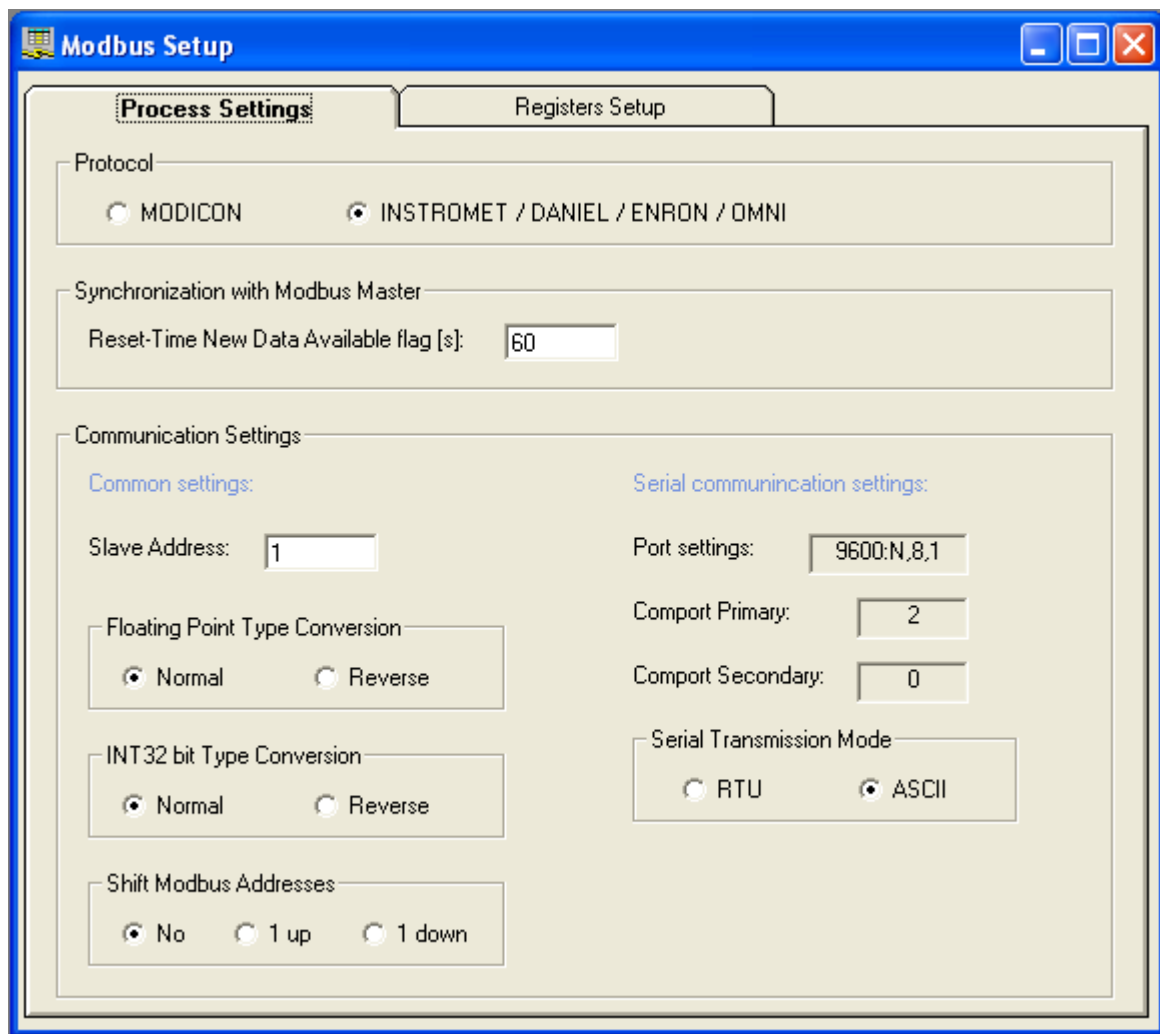

4 Standard Operations

4.1 Introduction

This menu describes standard operations which most of operators will perform on a regular base:

- **Sequence** (sample gas order)
- **Calibration** (calibration)
- **Peaks** (Setting the retention times)
- **Verification** (Verify)
- **Alarms** (set the limits for alarms)
- **Modbus Setup** (Setting up the Modbus table)
- **Report** (creating logs)

4.2 Sample gas order (Sequence)

The **Automation / Sequence** menu allows you to specify a particular sequence of measurement paths, calibrations and verifications.

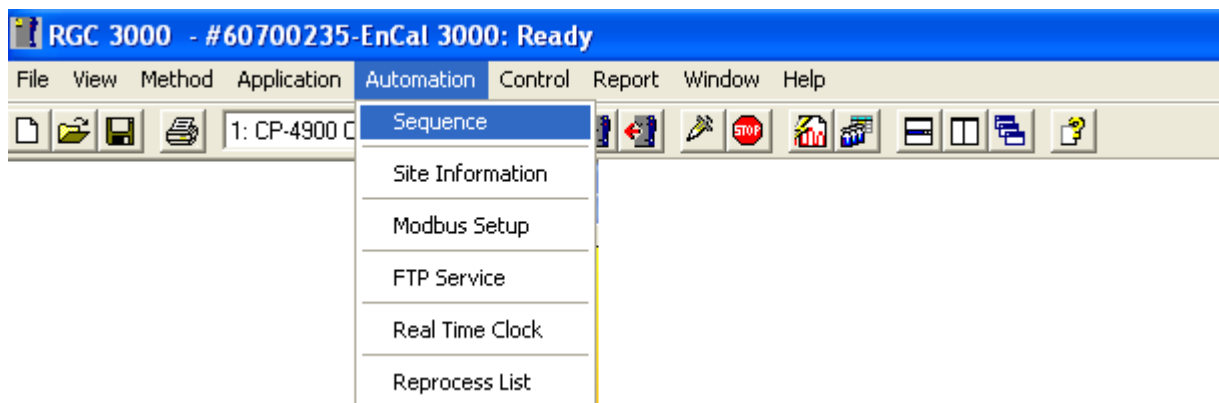

The selection of the menu **Sequence** opens the following dialog box with several tabs. The Sequence is Independent of the number of channels used.

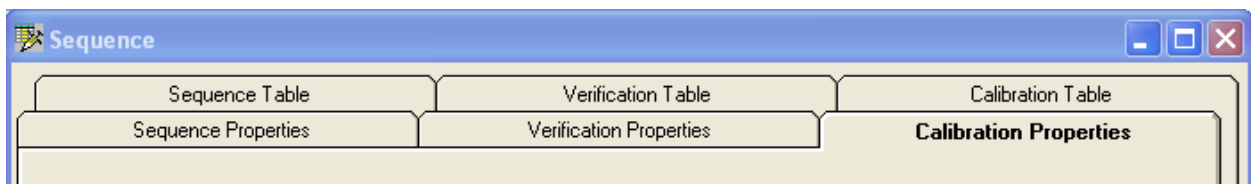

The tabs of the menu **Sequence** used to define the normal operating cycle. This cycle can be interrupted at customer defined times or events, through a verification or calibration: see sections below.

Select tab sheet **Sequence Table** with a click on it:

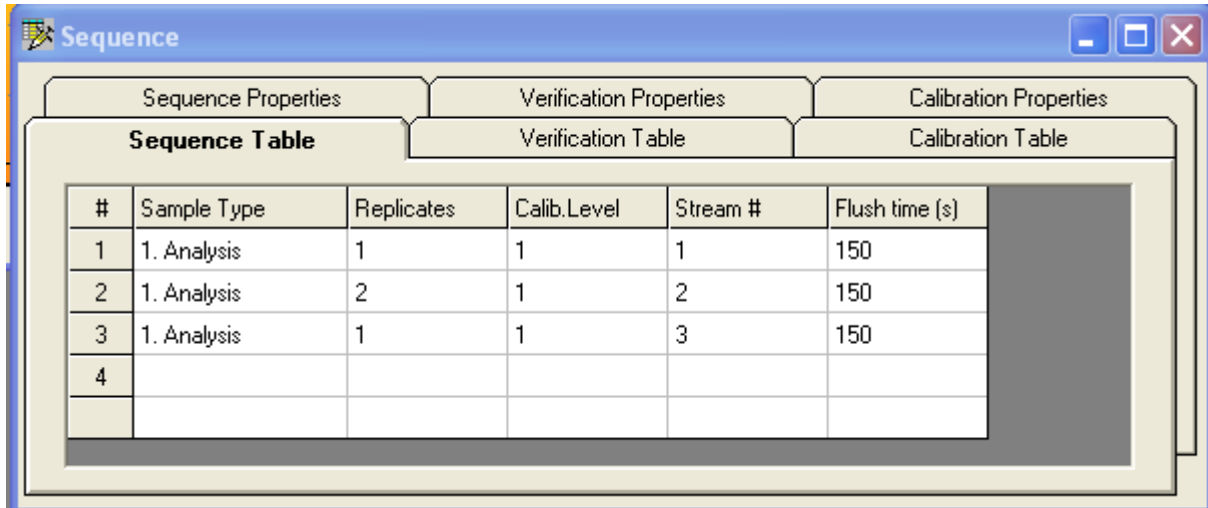

In the above Sequence Table, the following sequence of sample streams is programmed:

1. 1 run of STR1
2. 2 runs of STR2
3. 1 run of STR3

Once started, the analyser will run continuously through this cycle, only interrupted by verifications or calibration (see further).

In principle a calibration or verification could also be programmed in **Sequence Table**. See shown options in the next figure:

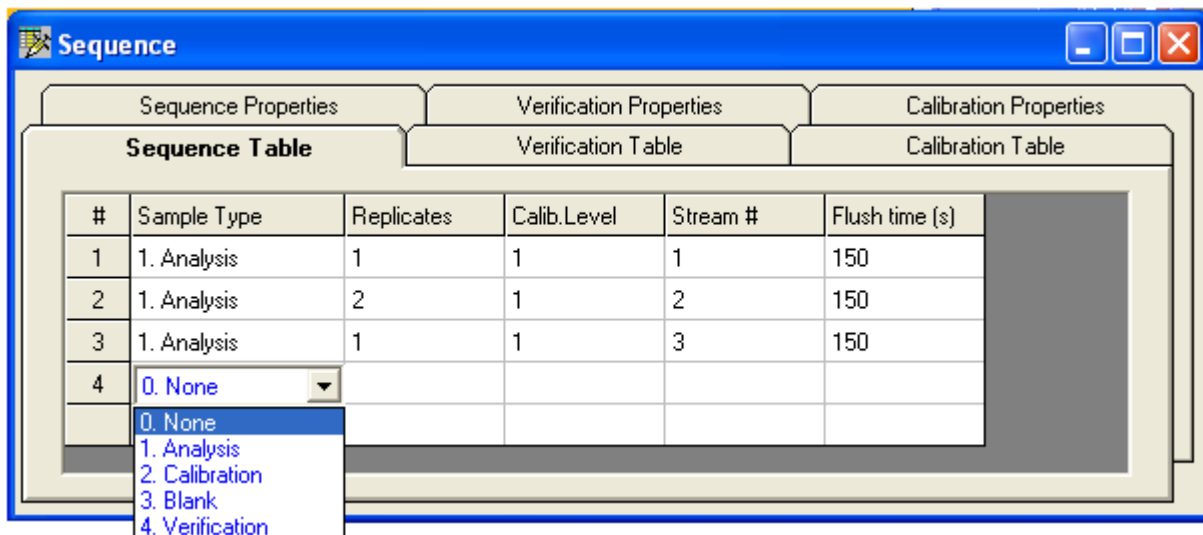

Analysis (Analysis),
Blank (purge)

Calibration (calibrate)
Verification (verify)

Conducting verifications and calibrations is typically triggered based on a specific time or a specific event. But since this table is designed for continuous use, it is better to use the appropriate tabs for the verification and calibration.

Other parameters in **Sequence Table**:

- Replicates: number of runs to be done consecutively, normally 1
- Calib. Level: The calibration level for the EnCal 3000 is default set to 1.
When using a multi-level calibration of the level 8 for daily calibration is used.
- Stream #: number of the physical connection port of the stream
- Flush time: should be less than 180 s.

The **Flush Time** will only be taken into account at the first run. During the next streams it will be hidden in the so-called **Stream Ahead Flushing**, which is standard programmed for the EnCal 3000. Flush time only serves as a safety back-up for the first run, but is not used once the analyser is running its continuous cycle of analyses.

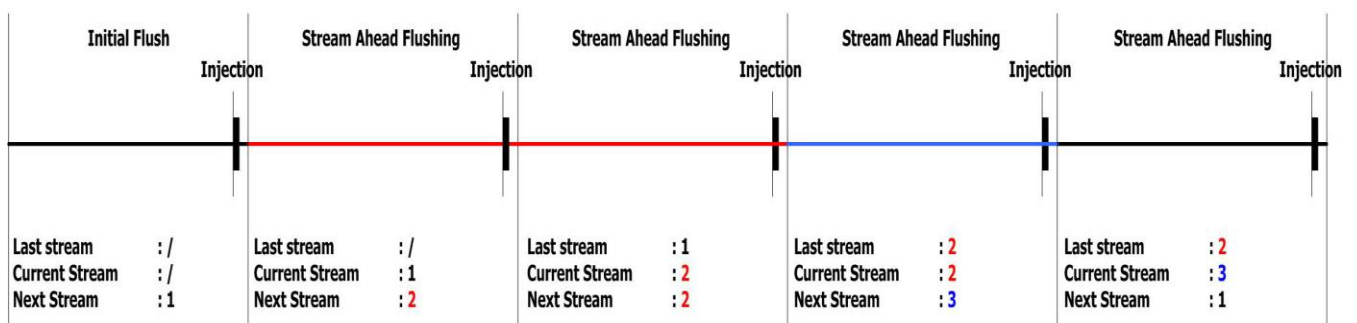

Sequence Properties allows defining the following parameters:

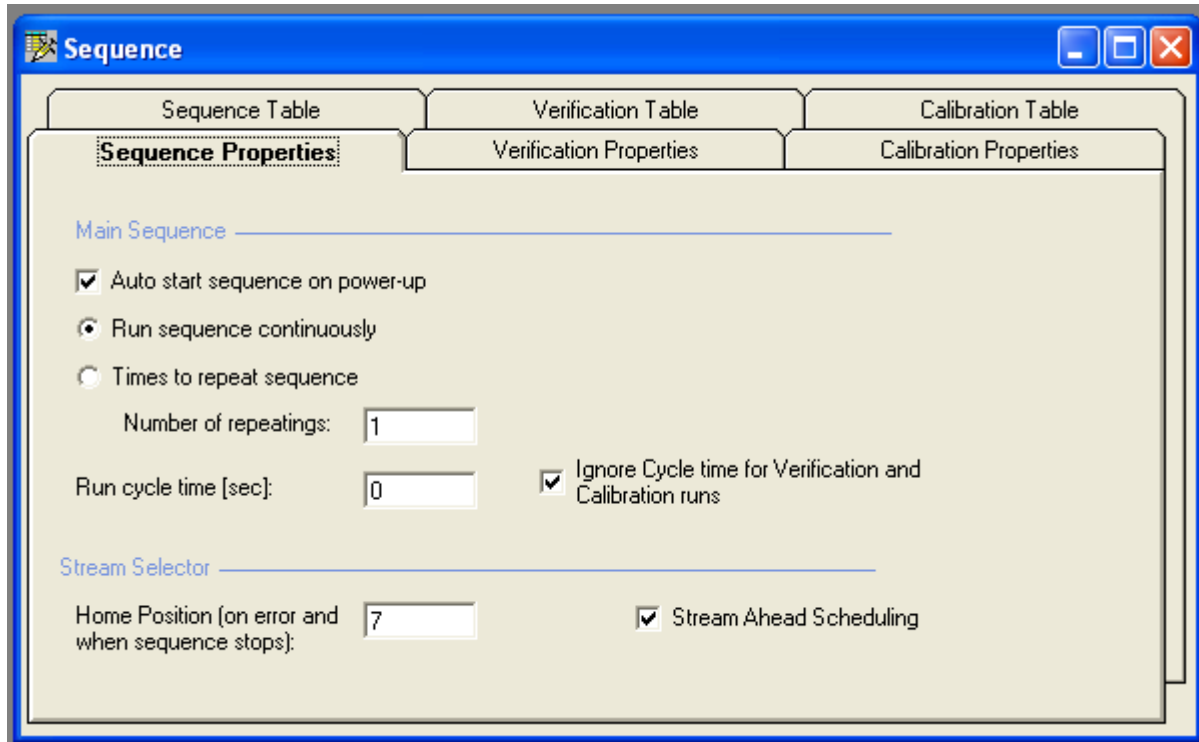

- **Auto start sequence on power-up:** Automatic start of the sequence for switching.
- **Run sequence continuously:** Selected by default t.
- **Times to repeat sequence:** Not used in normal operation (only for test purposes)
Number of repeating's:
- **Run cycle time:** Ration of a cyclic passage
- **Ignore Cycle time for Verification and Calibration run:** Ignore duration of verification and calibration pass.
- **Home Position:** This is either 0 (if all stream select valves need to be closed in case of errors or when the sequence stops), or one of the physically connected streams
- **Stream Ahead Scheduling:** Selected by default, if this option is activated the next stream to analyse would be flushed during the actual analysis. If not selected an extra flushing time is needed before the next Analysis on the other stream would be started.

4.3 Calibration

Most users will only have to change the calibration gas composition according to the actual calibration gas, and adjusting the calibration time according to contractual specifications. For the other parameters, it will not be needed to change the factory settings.

Make sure that the calibration gas composition corresponds to the process gas and the quality of the components is 2.0 (max. 1% relative uncertainty) or better. This is a requirement to ensure adequate accuracy of the device to achieve.

The definition of the calibration involves 5 menus:

- **Calibration Settings:** various calibration characteristics
- **Peak Identification Table:** calibration gas composition
- **Calibration Table:** timing of the calibration
- **Calibration Properties:** Start and completion time
- **Site Info:** calorific value and density of calibration gas

In the **Calibration Settings** dialog box under the menu item **Peak Calibration** (menu **Method**), the calibration settings for the selected channel will be displayed. Also the type of calibration can be set.

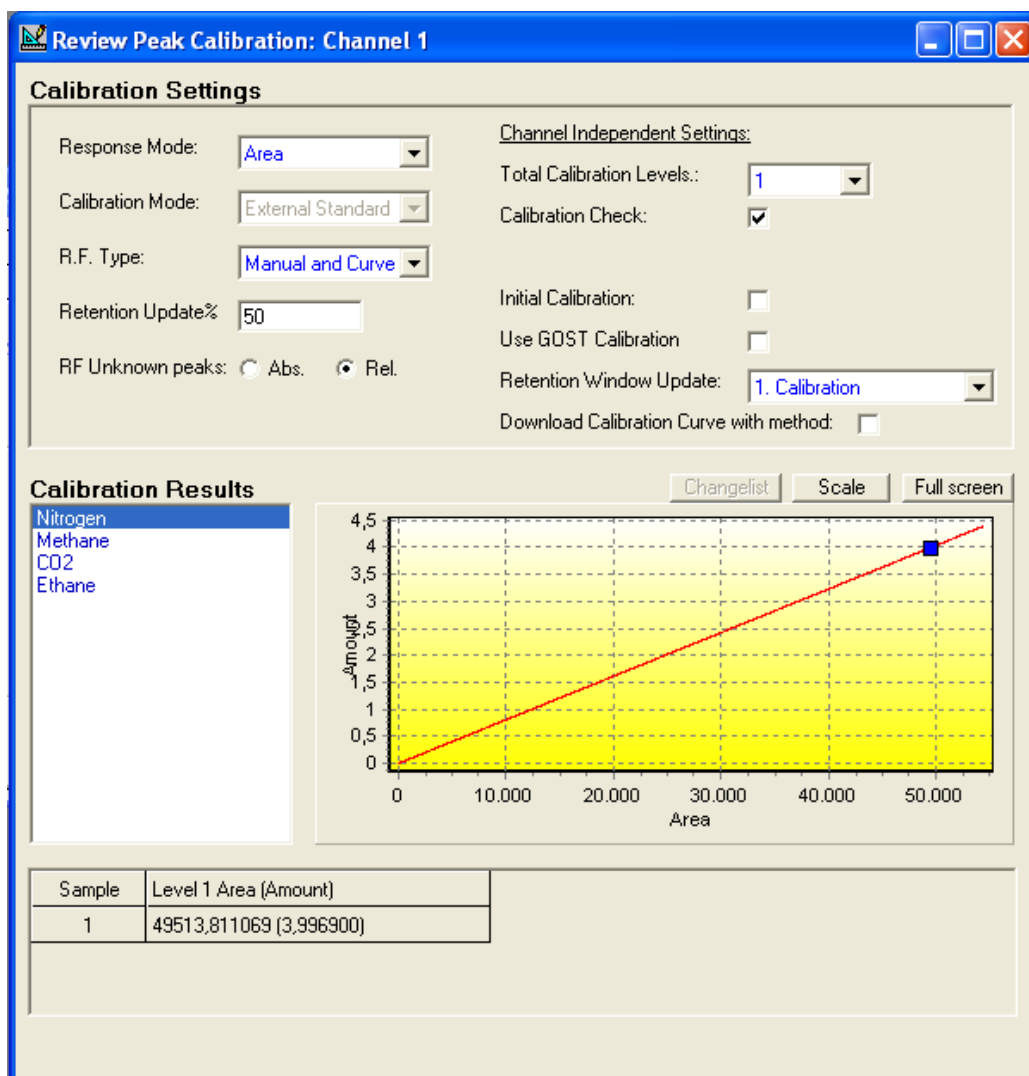

Calibration Settings

Response Mode: Channel Independent Settings:

Calibration Mode: Total Calibration Levels.:

R.F. Type: Calibration Check:

Retention Update%: Initial Calibration:

RF Unknown peaks: Abs. Rel. Use GOST Calibration:

Retention Window Update: Download Calibration Curve with method:

Calibration Results

Nitrogen
Methane
CO2
Ethane

Amount

Area

Sample	Level 1 Area (Amount)
1	49513,811069 (3,996900)

Following parameters are defined:

- Response Mode:** Area by default.
- RF Type:** Manual and Curve by default.
- Retention Update:** Defines the actual shift of retention time. Typically 50 % are sufficient for a correction of non-typical changes of the retention times.
- RF Unknown Peaks:** Response factors of unknown variables can be set in two ways: Relative (Rel.) is used in a formula the response factor of the nearest known component. Absolute (Abs.) used in a formula or entered value from the literature. 0 is the default.
- Calibration Check:** is enabled by default, so it is checked how much the response factors for the individual components in comparison to the last calibration and the basic calibration has changed.
- Initial Calibration:** Only activated during an initial calibration (FAT, SAT, or when a new calibration gas is connected. When enabled, all deleted before calculated response factors and by a basic calibration recalculated
- Use GOST Calibration:** This option allows you to calibrate the device after the GOST standard. By activating this field **Calibration Check** and / or **Initial Calibration** can be switched off and set further parameters on other sites already automatically.
- Retention Window update:** **Calibration** is preset. An update of the Retention window for each analysis may be performed theoretically, but in practice this is not needed, and would impact the processor with an unnecessary amount of computations.
- Download Calibration Curve with method:** Not activated by default. This option has to be used to download an entered response function. An example for the use of this option is entering an external calculated response function from a multilevel calibration.

In the **Calibration Settings** dialog box additional the **Calibration Results** are shown. To change the channel for viewing, click on the channel selection in the header. All existing channels can be chosen.



The calibration gas composition needs to be entered in the **Peak Identification** table (under menu Method) for the all channels.

For standard applications the Level1 column is provided. When using a multi-level calibration for daily calibration Level 8 column is to use.

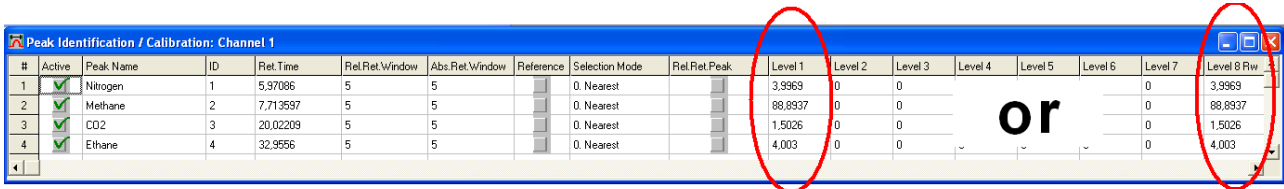

#	Active	Peak Name	ID	Ret. Time	Ret.Ret.Window	Abs.Ret.Window	Reference	Selection Mode	Ret.Ret.Peak	Level 1	Level 2	Level 3	Level 4	Level 5	Level 6	Level 7	Level 8 Rvw
1	✓	Nitrogen	1	5.37086	5	5		0. Nearest		3.9969	0	0					3.9969
2	✓	Methane	2	7.713597	5	5		0. Nearest		88.8937	0	0					88.8937
3	✓	CO2	3	20.02209	5	5		0. Nearest		1.5026	0	0					1.5026
4	✓	Ethane	4	32.9556	5	5		0. Nearest		4.003	0	0					4.003

Therefore again, as described above, choose the corresponding channel in the header of the RGC 3000-software, the menu item **Peak Identification** remains open.

If the calibration according to the GOST standard used in this table also the values from those used in the standard tables "Table 2" and "Appendix A, Table 1," for each channel must be entered (see picture).

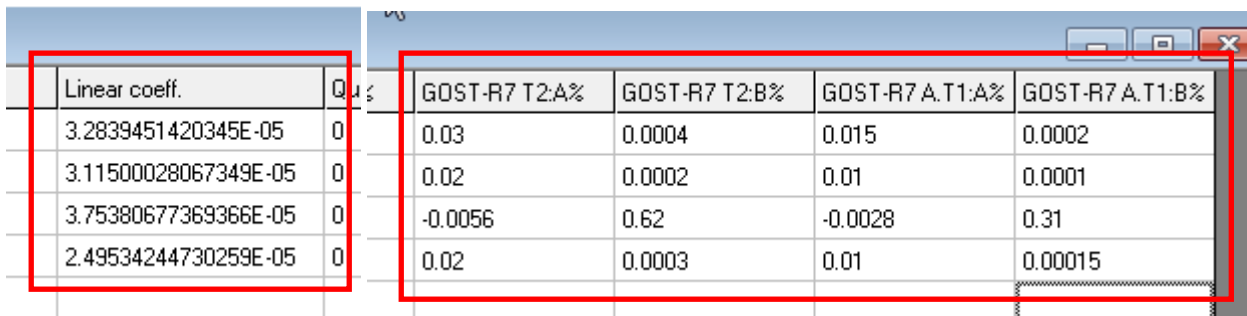

Linear coeff.	Quadratic coeff.	GOST-R7 T2:A%	GOST-R7 T2:B%	GOST-R7 A.T1:A%	GOST-R7 A.T1:B%
3.2839451420345E-05	0	0.03	0.0004	0.015	0.0002
3.11500028067349E-05	0	0.02	0.0002	0.01	0.0001
3.75380677369366E-05	0	-0.0056	0.62	-0.0028	0.31
2.49534244730259E-05	0	0.02	0.0003	0.01	0.00015

In the **Peak Identification** table also limits on the response factors for the individual components in comparison to the last calibration and the basic calibration are set. Should be the change over a certain threshold, in the figure below 5%, the newly determined response factors are discarded.

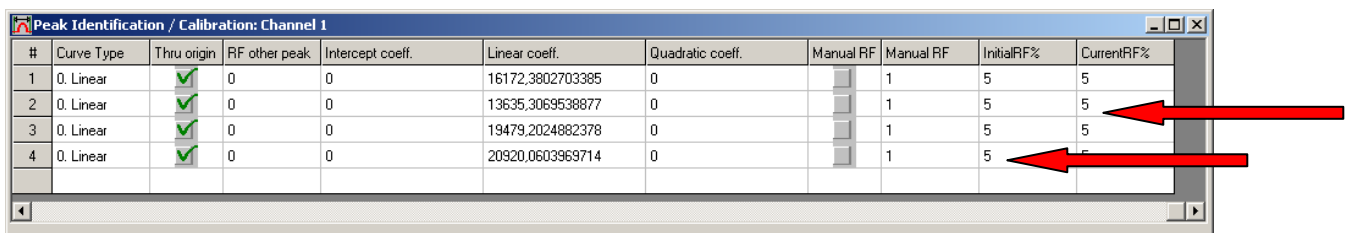

#	Curve Type	Thru origin	RF other peak	Intercept coeff.	Linear coeff.	Quadratic coeff.	Manual RF	Manual RF	InitialRF%	CurrentRF%
1	0. Linear	✓	0	0	16172.3802703385	0		1	5	5
2	0. Linear	✓	0	0	13635.3069538877	0		1	5	5
3	0. Linear	✓	0	0	19479.2024882378	0		1	5	5
4	0. Linear	✓	0	0	20920.0603969714	0		1	5	5

The **Automation / Sequence** menu allow the tabs for the calibration to determine the nature and timing of calibration.

In tab. sheet **Calibration Table** the number and the nature of the passes, which are used for the calibration, indicated.

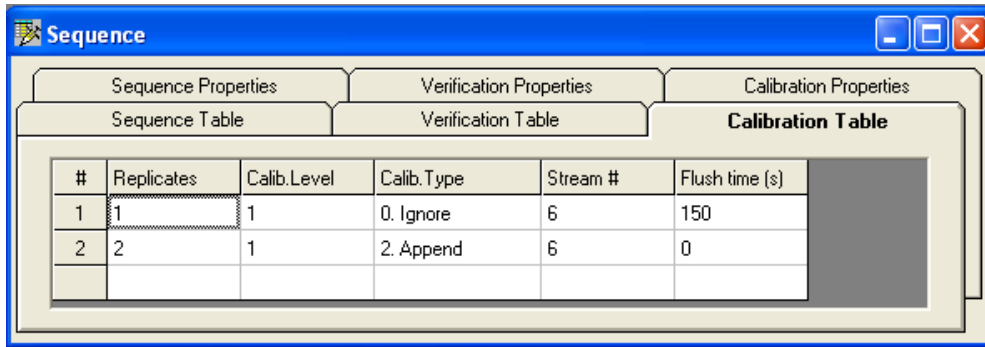

#	Replicates	Calib.Level	Calib.Type	Stream #	Flush time (s)
1	1	1	0. Ignore	6	150
2	2	1	2. Append	6	0

In the above example, a calibration consists of:

1. One Ignore run, i.e. the system is flushed with calibration gas, but the analysis data are not taken into account for the calculation of the response factors
2. Two Append runs, i.e. the average response factors are calculated after all calibration runs are executed

For “**Calib. Type**”, also “**Replace**” could be selected. This means a new calculation of the response factors after every new calibration run.

Note also that in the above example the calibration gas is physically connected to port 6, which might be different for other applications.

If the calibration after the GOST standard chosen, the tab **Calibration Table** automatically changes to the values shown below.

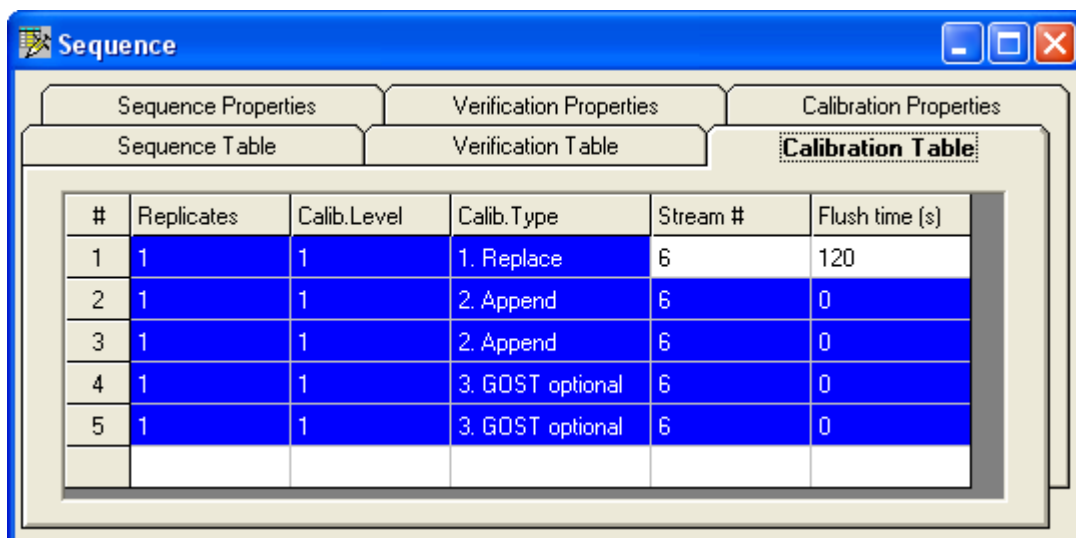

#	Replicates	Calib.Level	Calib.Type	Stream #	Flush time (s)
1	1	1	1. Replace	6	120
2	1	1	2. Append	6	0
3	1	1	2. Append	6	0
4	1	1	3. GOST optional	6	0
5	1	1	3. GOST optional	6	0

Please remember that a calibration by deselecting the GOST standard or a switch between GOST standard and the other calibration methods require a further adjustment of the table.

Calibration Properties allows defining the following parameters:

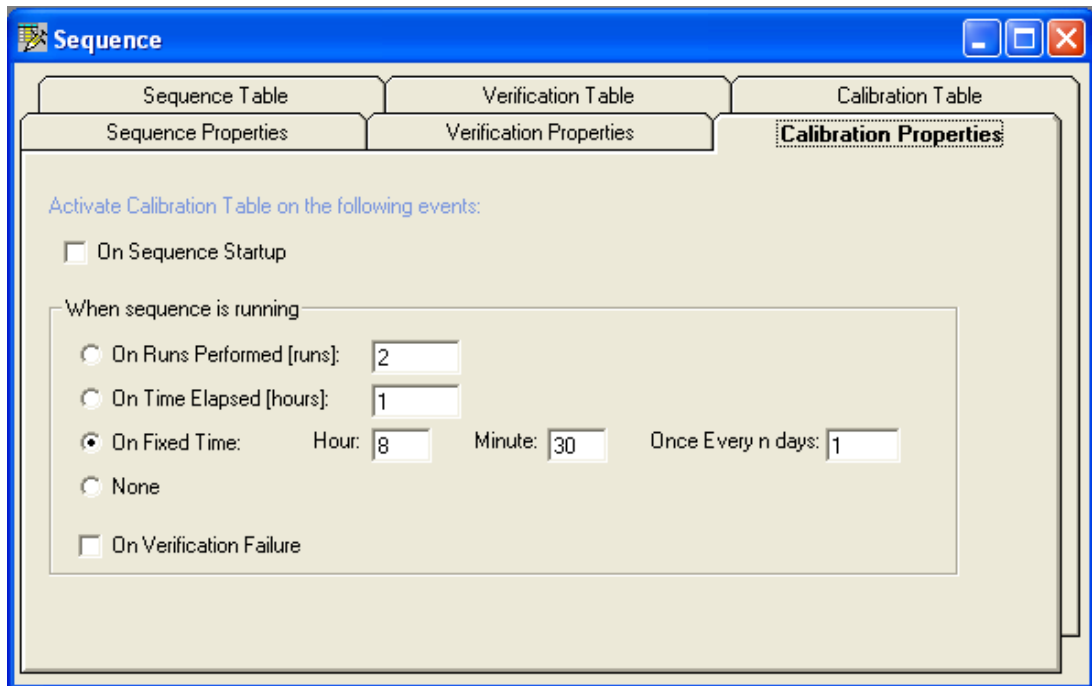

- Automatic start when starting the sequence (**Auto start on sequence start-up**)
- start at specific events (**Start-up on events**)
- (Number of times or the number of elapsed hours)
- calibration at a specified time (**Calibration on fixed time**): this is the default selection
- calibration with an error in the verification (**Calibration on verification failure**)

In the above example, the gas chromatograph is calibrated each day at 8:30 clock in the morning.

If the calibration is chosen according to the GOST standard can only be changed the day and time. The other parameters are locked.

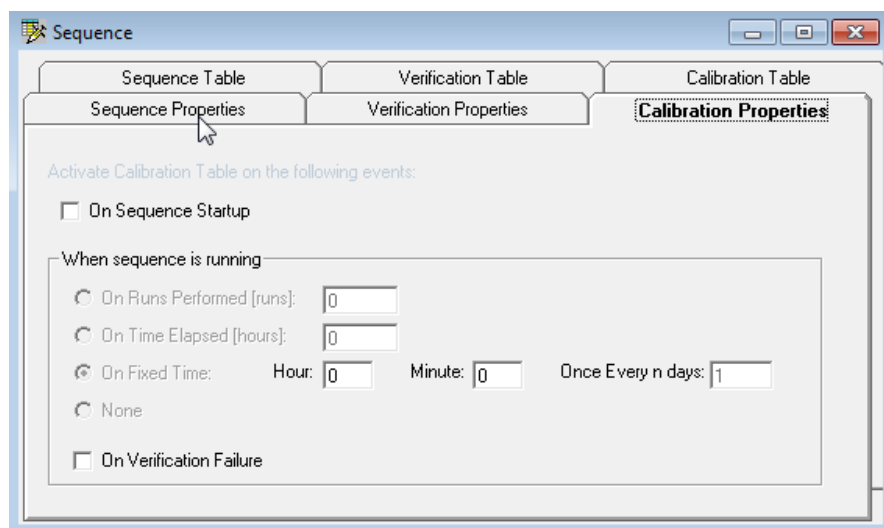

The calorific value and density are under the **Automation** menu submenu **Site Info**.

It looks like this:

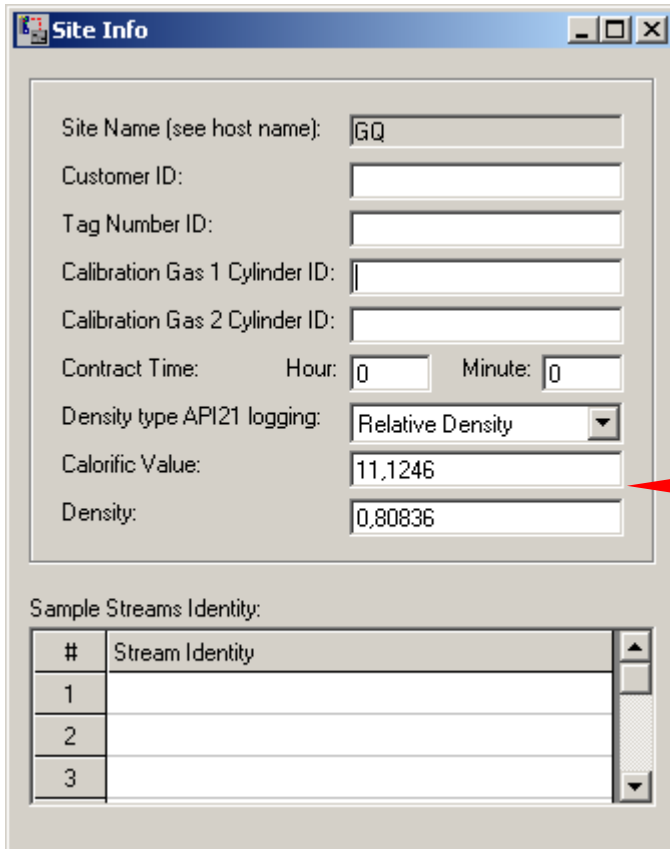

#	Stream Identity
1	
2	
3	

In the example above, the values of the calorific value and the density of the calibration are shown.

This data is transmitted to the controller EnCal 3000 for display and are under the Calibration menu appears (see manual of the controller EnCal 3000).

If these values are not specified, the target values for calorific value and density on the EnCal 3000 controller are not displayed correctly.

4.4 Setting the retention times (Peaks)

The retention times need to be adjusted in case the temperature or pressure settings of the channels are modified. All channels work completely independent, so if only one channel is touched, only the retention times of this channel have to be modified.

Adjustment occurs in menu **Method / Peak Identification**:

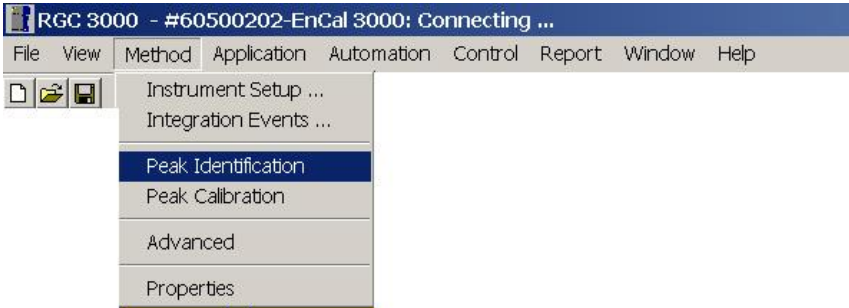

#	Active	Peak Name	ID	Retention	Rel.Ret.Window	Abs.Ret.Window	Reference	Selection Mode	Rel.Ret.Peak	Level 1	Level 2	Lev
1	<input checked="" type="checkbox"/>	Nitrogen	1	7.132815	5	5		0. Nearest		11.0037	0	0
2	<input checked="" type="checkbox"/>	Methane	2	9.397362	5	5		0. Nearest		86.011	0	0
3	<input checked="" type="checkbox"/>	CO2	3	23.26828	5	5		0. Nearest		1.552	0	0
4	<input checked="" type="checkbox"/>	Ethane	4	38.13656	5	5		0. Nearest		0.75	0	0

The other channels can be selected in the header of the RGC 3000 software, if necessary:



Once the analysis is stable, please record the retention time for each peak by using the mouse to click and read the signal peak in the upper left corner of the corresponding retention time (see figure).



Fill in the results under menu **Peak Identification**.

Save the method on the hard disk and export them to the gas chromatograph.

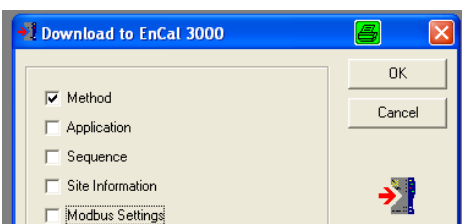

4.5 Verification

Verification is typically used to evaluate the performance of the analyser by analysing the calibration gas and comparing the results with the certificate data.

In principle this could also be performed on any test gas with known composition, but the use of the calibration gas is of course the most practical option.

The measurement parameters are set via the menu item **Verification Check** in the menu **Application**.

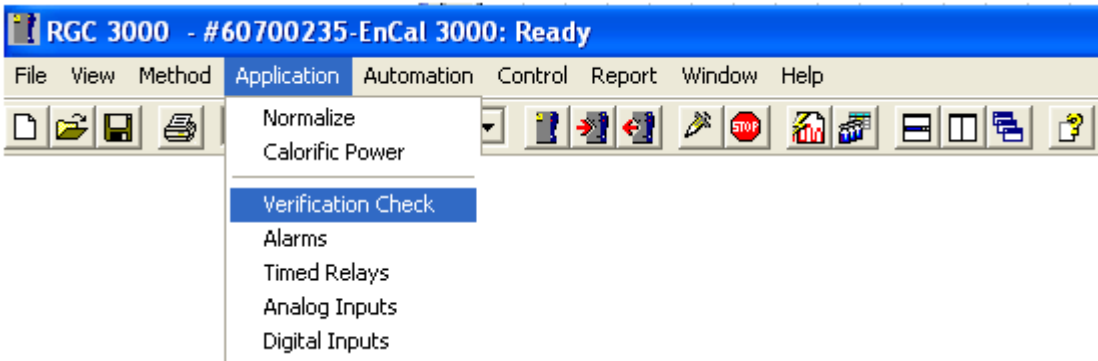

Verification Table allows entering minimum and maximum values for the measured properties:

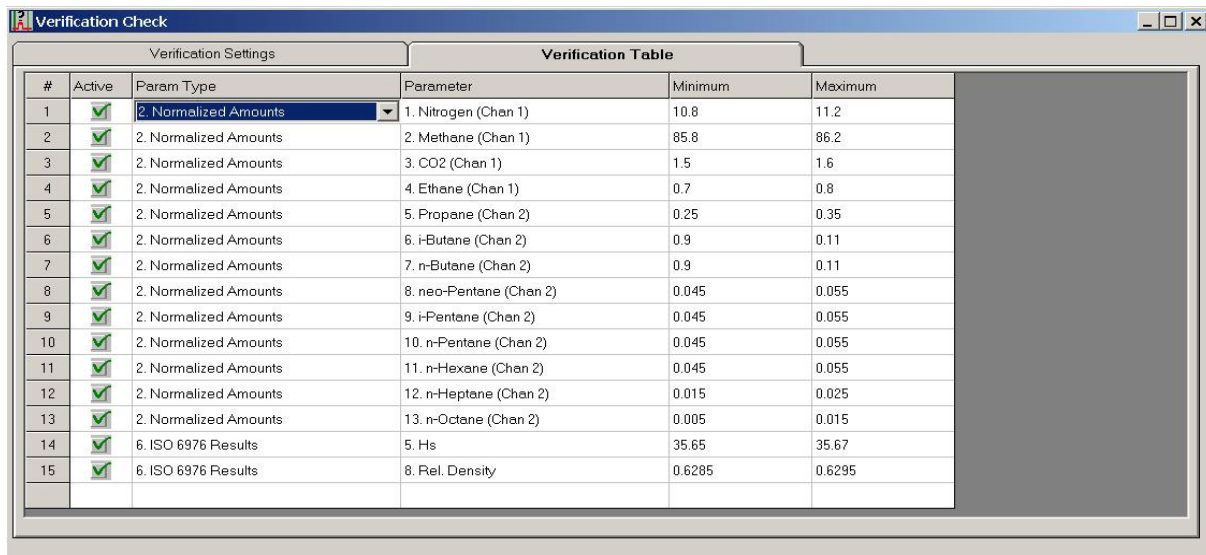

#	Active	Param Type	Parameter	Minimum	Maximum
1	<input checked="" type="checkbox"/>	2. Normalized Amounts	1. Nitrogen (Chan 1)	10.8	11.2
2	<input checked="" type="checkbox"/>	2. Normalized Amounts	2. Methane (Chan 1)	85.8	86.2
3	<input checked="" type="checkbox"/>	2. Normalized Amounts	3. CO2 (Chan 1)	1.5	1.6
4	<input checked="" type="checkbox"/>	2. Normalized Amounts	4. Ethane (Chan 1)	0.7	0.8
5	<input checked="" type="checkbox"/>	2. Normalized Amounts	5. Propane (Chan 2)	0.25	0.35
6	<input checked="" type="checkbox"/>	2. Normalized Amounts	6. i-Butane (Chan 2)	0.9	0.11
7	<input checked="" type="checkbox"/>	2. Normalized Amounts	7. n-Butane (Chan 2)	0.9	0.11
8	<input checked="" type="checkbox"/>	2. Normalized Amounts	8. neo-Pentane (Chan 2)	0.045	0.055
9	<input checked="" type="checkbox"/>	2. Normalized Amounts	9. i-Pentane (Chan 2)	0.045	0.055
10	<input checked="" type="checkbox"/>	2. Normalized Amounts	10. n-Pentane (Chan 2)	0.045	0.055
11	<input checked="" type="checkbox"/>	2. Normalized Amounts	11. n-Hexane (Chan 2)	0.045	0.055
12	<input checked="" type="checkbox"/>	2. Normalized Amounts	12. n-Heptane (Chan 2)	0.015	0.025
13	<input checked="" type="checkbox"/>	2. Normalized Amounts	13. n-Octane (Chan 2)	0.005	0.015
14	<input checked="" type="checkbox"/>	6. ISO 6976 Results	5. Hs	35.65	35.67
15	<input checked="" type="checkbox"/>	6. ISO 6976 Results	8. Rel. Density	0.6285	0.6295

Don't forget to activate the verification table in **Verification Settings**!

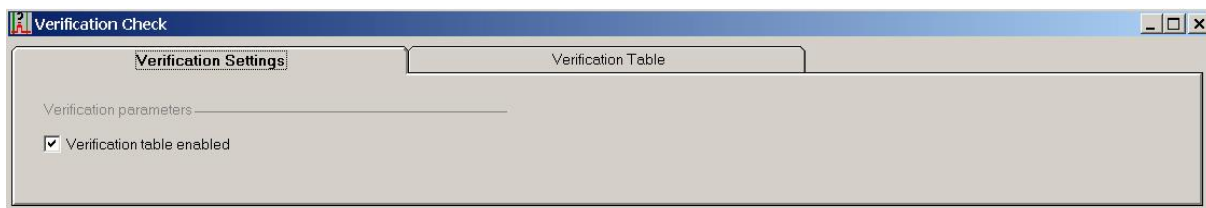

Verification Properties allows to program verification as an event, for example every 10000 analyses.

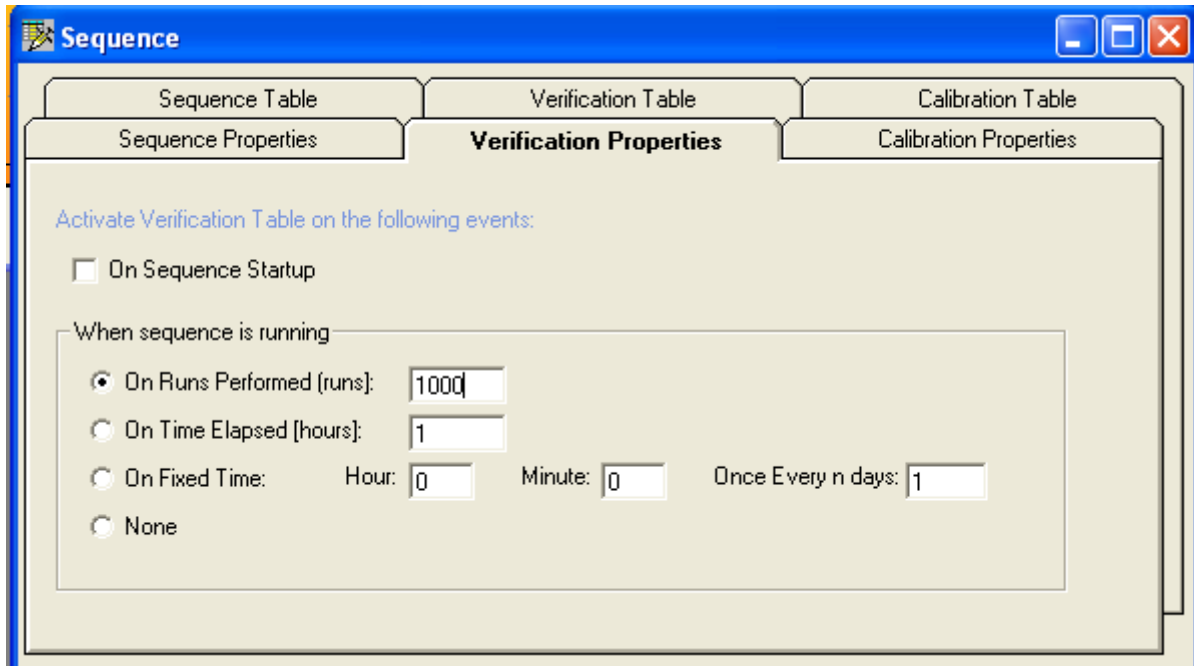

Verification Table allows defining the number of runs for the verification, and which physical stream to be selected (normally the calibration input).

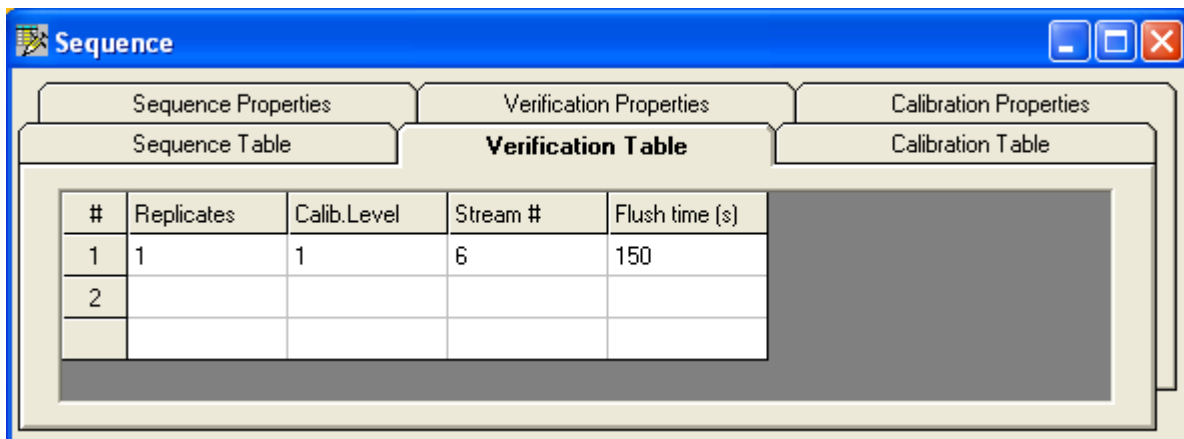

4.6 Setting the limits for alarms (Alarms)

Settings for alarm messages are done in the **Application / Alarms** menu:

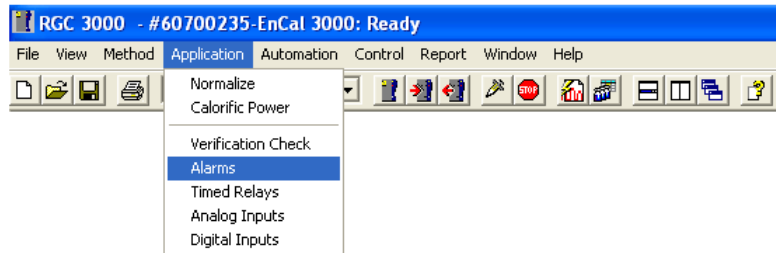

The **Alarm Table** allows entering minimum and maximum values for the measured properties:

Alarm Settings				Alarm Table						
#	Active	Param Type	Parameter	Minimum	Maximum	Alarm On	Invert Alarm	Relay Alarm	Relay #	Invert Relay
1	<input checked="" type="checkbox"/>	2. Normalized Amounts	1. Nitrogen (chan 1)	0	22	5. All	<input type="checkbox"/>	<input type="checkbox"/>	0. None	<input type="checkbox"/>
2	<input checked="" type="checkbox"/>	2. Normalized Amounts	2. Methane (chan 1)	55	100	5. All	<input type="checkbox"/>	<input type="checkbox"/>	0. None	<input type="checkbox"/>
3	<input checked="" type="checkbox"/>	2. Normalized Amounts	3. CO2 (chan 1)	0	12	5. All	<input type="checkbox"/>	<input type="checkbox"/>	0. None	<input type="checkbox"/>
4	<input checked="" type="checkbox"/>	2. Normalized Amounts	4. Ethane (chan 1)	0	14	5. All	<input type="checkbox"/>	<input type="checkbox"/>	0. None	<input type="checkbox"/>
5	<input checked="" type="checkbox"/>	2. Normalized Amounts	5. Propane (chan 2)	0	5	5. All	<input type="checkbox"/>	<input type="checkbox"/>	0. None	<input type="checkbox"/>
6	<input checked="" type="checkbox"/>	2. Normalized Amounts	6. i-Butane (chan 2)	0	1,5	5. All	<input type="checkbox"/>	<input type="checkbox"/>	0. None	<input type="checkbox"/>
7	<input checked="" type="checkbox"/>	2. Normalized Amounts	7. n-Butane (chan 2)	0	1,5	5. All	<input type="checkbox"/>	<input type="checkbox"/>	0. None	<input type="checkbox"/>
8	<input checked="" type="checkbox"/>	2. Normalized Amounts	8. neo-Pentane (chan 2)	0	0,1	5. All	<input type="checkbox"/>	<input type="checkbox"/>	0. None	<input type="checkbox"/>
9	<input checked="" type="checkbox"/>	2. Normalized Amounts	9. i-Pentane (chan 2)	0	0,3	5. All	<input type="checkbox"/>	<input type="checkbox"/>	0. None	<input type="checkbox"/>
10	<input checked="" type="checkbox"/>	2. Normalized Amounts	10. n-Pentane (chan 2)	0	0,3	5. All	<input type="checkbox"/>	<input type="checkbox"/>	0. None	<input type="checkbox"/>
11	<input checked="" type="checkbox"/>	2. Normalized Amounts	11. n-Hexane (chan 2)	0	0,3	5. All	<input type="checkbox"/>	<input type="checkbox"/>	0. None	<input type="checkbox"/>
12	<input checked="" type="checkbox"/>	6. ISO 6976 Results	5. Hs	7,3	14,9	5. All	<input type="checkbox"/>	<input type="checkbox"/>	0. None	<input type="checkbox"/>
13	<input checked="" type="checkbox"/>	6. ISO 6976 Results	7. Abs. Density	0,72	1,2	5. All	<input type="checkbox"/>	<input type="checkbox"/>	0. None	<input type="checkbox"/>
14	<input checked="" type="checkbox"/>	3. Sample results	1. Sum ESTD	97	103	5. All	<input type="checkbox"/>	<input type="checkbox"/>	0. None	<input type="checkbox"/>
15	<input checked="" type="checkbox"/>	8. GC Status	1. Instrument Error	2	3	5. All	<input type="checkbox"/>	<input type="checkbox"/>	0. None	<input type="checkbox"/>
16	<input checked="" type="checkbox"/>	2. Normalized Amounts	12. n-Heptane (chan 2)	0	0,3	5. All	<input type="checkbox"/>	<input type="checkbox"/>	0. None	<input type="checkbox"/>
17	<input checked="" type="checkbox"/>	2. Normalized Amounts	13. n-Octane (chan 2)	0	0,3	5. All	<input type="checkbox"/>	<input type="checkbox"/>	0. None	<input type="checkbox"/>
18	<input checked="" type="checkbox"/>	2. Normalized Amounts	14. n-Nonane (chan 2)	0	0,3	5. All	<input type="checkbox"/>	<input type="checkbox"/>	0. None	<input type="checkbox"/>
19	<input checked="" type="checkbox"/>	2. Normalized Amounts	16. Benzene (chan 2)	0	0,3	5. All	<input type="checkbox"/>	<input type="checkbox"/>	0. None	<input type="checkbox"/>
20	<input checked="" type="checkbox"/>	2. Normalized Amounts	17. Cyclohexane (chan 2)	0	0,3	5. All	<input type="checkbox"/>	<input type="checkbox"/>	0. None	<input type="checkbox"/>
21	<input checked="" type="checkbox"/>	2. Normalized Amounts	18. Methylcyclohexane (chan 2)	0	0,3	5. All	<input type="checkbox"/>	<input type="checkbox"/>	0. None	<input type="checkbox"/>
22	<input checked="" type="checkbox"/>	2. Normalized Amounts	19. Toluene (chan 2)	0	0,3	5. All	<input type="checkbox"/>	<input type="checkbox"/>	0. None	<input type="checkbox"/>

In principle each alarm can be defined for only one sample type (i.e. analysis, calibration, verification or blank) in "Alarm On", but in practice this value will be put on "All". The table also allows assigning the alarm to a relay (max. 3).

Don't forget to activate the alarms in **Alarm Settings**!



4.7 Configuration of ModBus Table (Modbus Setup)

In **Automation / Modbus Setup** menu Modbus parameters of EnCal 3000 can be configured:

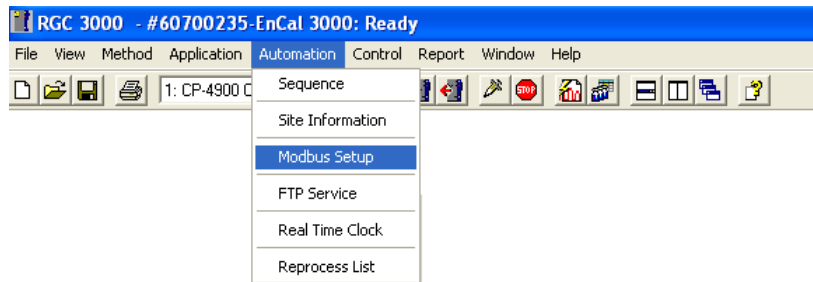

Process Settings defines the protocol settings. By default the EnCal 3000 is set-up for the Instromet RTU Modbus protocol, at a baud rate of 9600.

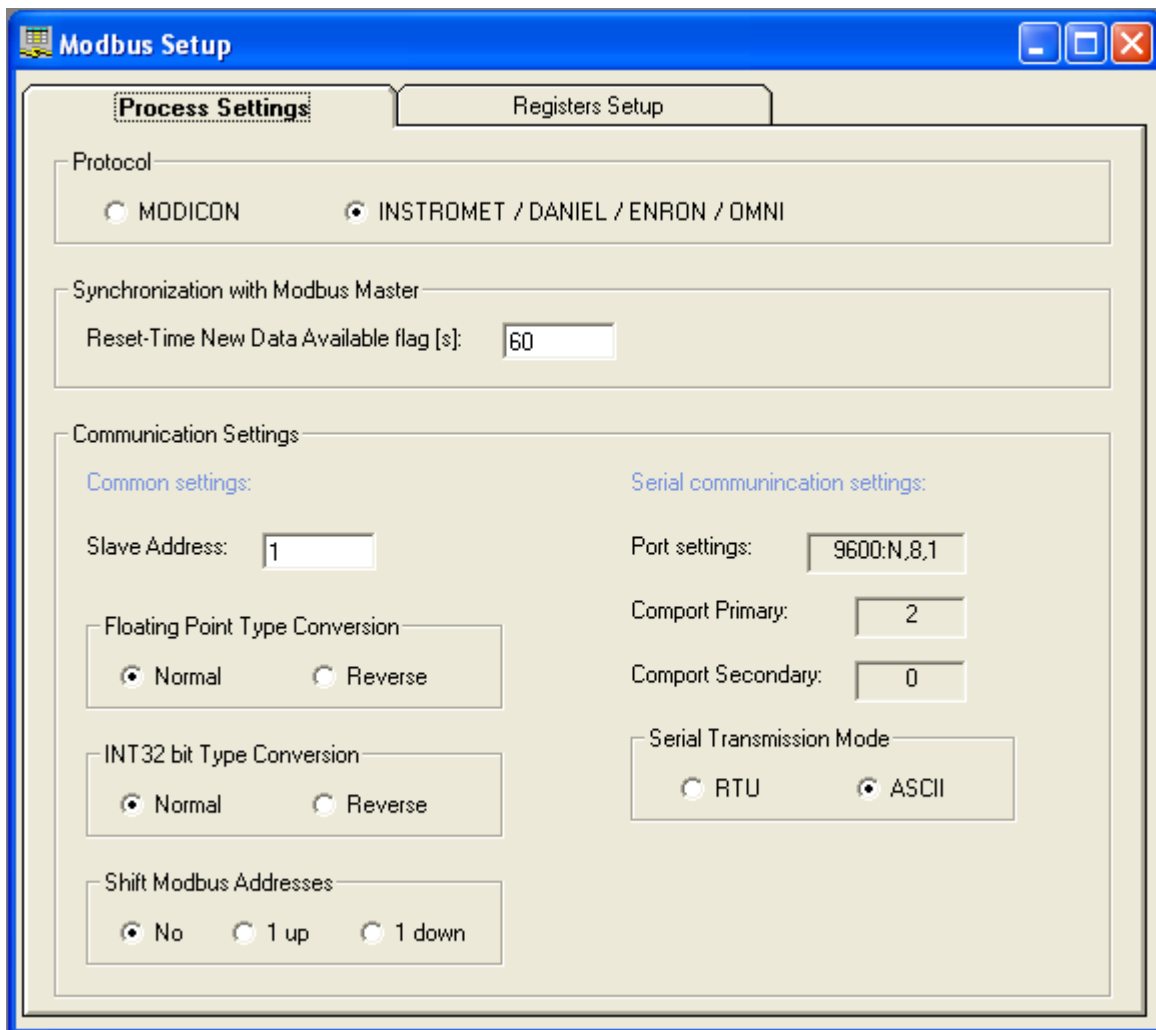

If needed, the baud rate could be changed in the configuration menu of the unit.



Quit RGC3000, and return to the start-up menu.

Select first the connected unit, then **Configure** under **Control**

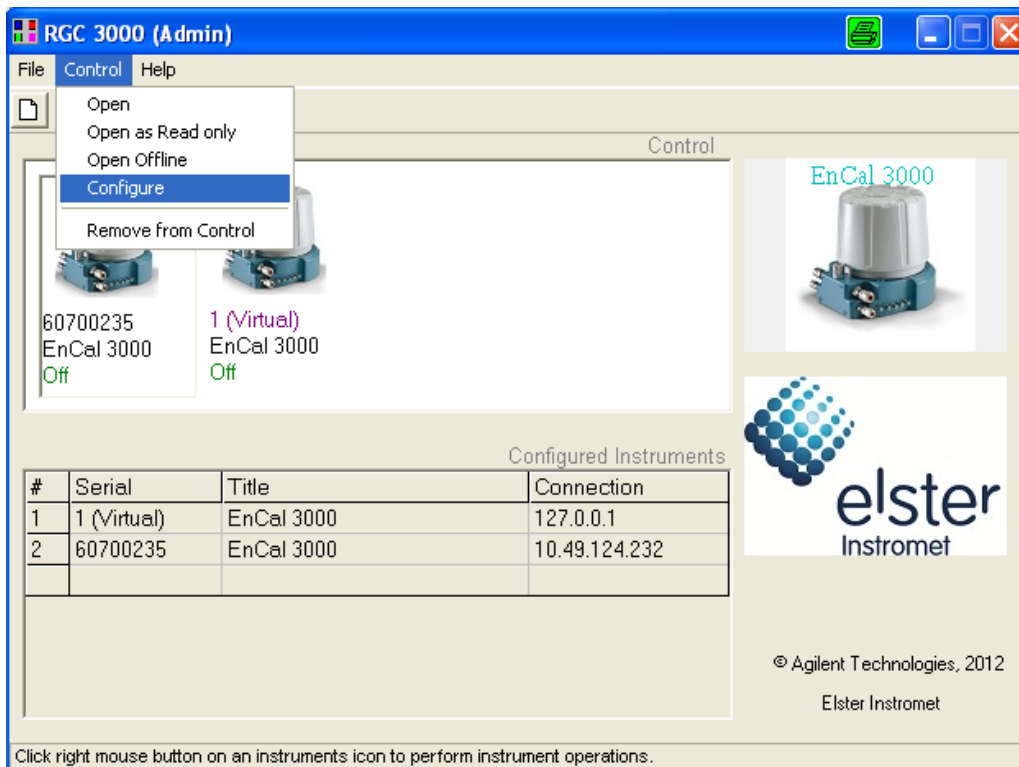

And again **Configure** in the next window.

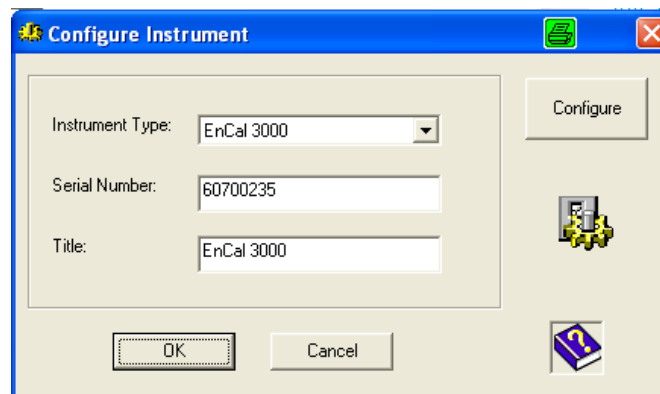

Select tab sheet **Automation** in the configuration screen.

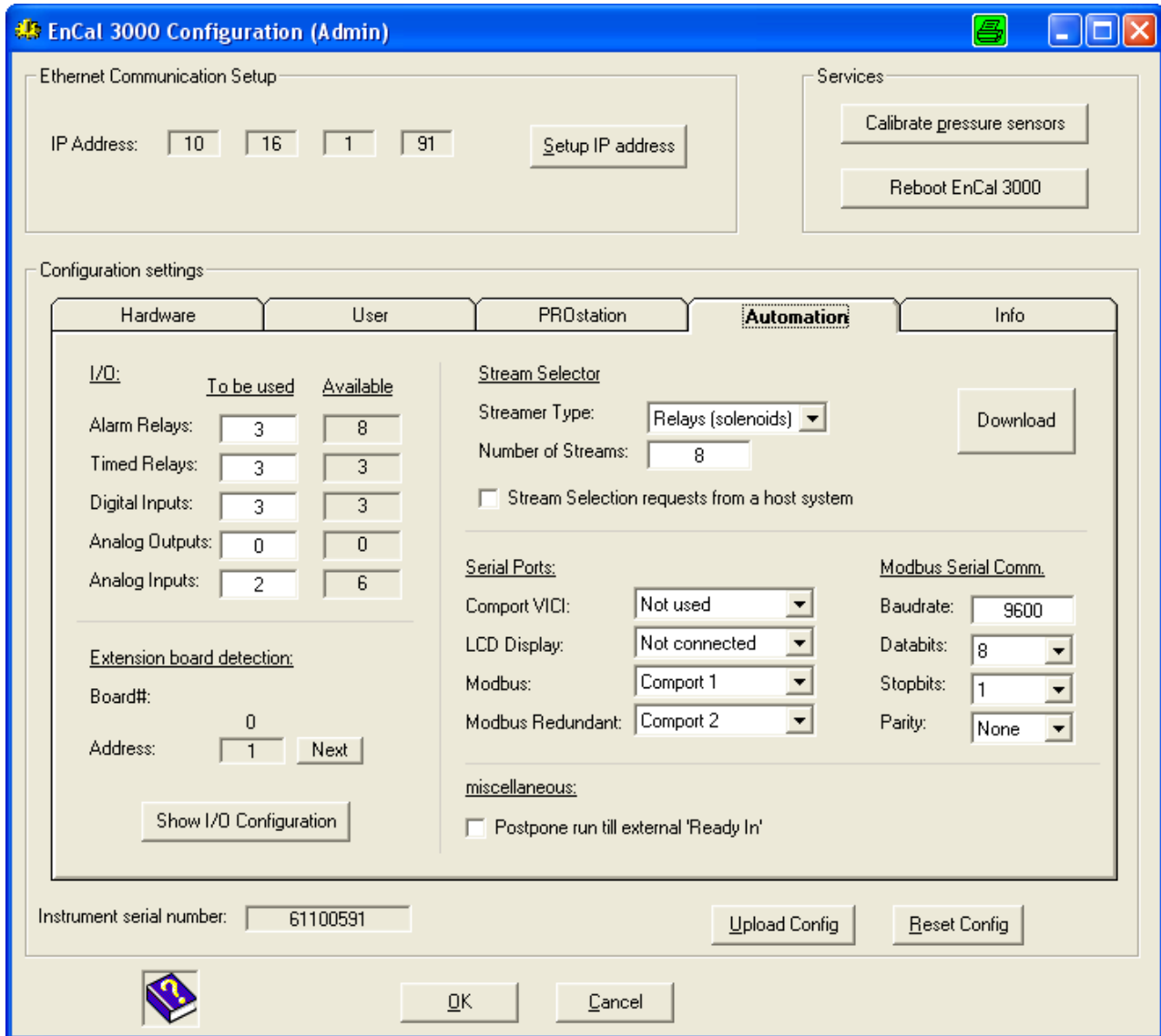

In the right lower corner the baud rate can be changed. Don't forget to download the new setting to the unit (after which the unit will ask you to restart, which can be done with the button in the upper right corner).

Never change the COM port settings; these define the internal COM port configuration of the EnCal 3000.

Register Setup allows configuring the ModBus registers are user configurable:

#	Active	Register Type	Register #	Data Type	Parameter ID	Channel	Peak#
15	<input checked="" type="checkbox"/>	2. Holding Register (RW)	7009	3. Float	2401. Appl.: Stream Component Norm%(Double, CHAN=stream, PEAK)	1. Stream 1	9

2. Holding Register (RW)	3. Float	2401. Appl.: Stream Component Norm%(Double, CHAN=stream, PEAK)	1. Stream 1
0. Coil Status (RW)	0. Bit	2401. Appl.: Stream Component Norm%(Double, CHAN=stream, PEAK)	0. None
1. Input Status (R)	1. Int16	2402. Appl.: Stream Alarm on Index(Int32, CHAN=stream, PEAK=index)	1. Stream 1
2. Holding Register (RW)	2. Int32	2403. Appl.: Stream Overall Alarm Status (Int32, CHAN=stream)	2. Stream 2
3. Input Register (R)	3. Float	2404. Appl.: Stream Compressibility (Double, CHAN=stream)	3. Stream 3
		2405. Appl.: Stream Wobbe Superior (Double, CHAN=stream)	4. Stream 4
		2406. Appl.: Stream ISO Hs (Double, CHAN=stream)	5. Stream 5
		2407. Appl.: Stream ISO Hi (Double, CHAN=stream)	6. Stream 6
		2408. Appl.: Stream ISO Abs Density (Double, CHAN=stream)	

- **Register Type:** Either Read Only (R) or Read/Write (R/W), and either bit (Status) or register size.
- **Register #:** User selectable. For the Instromet protocol be aware of the following restrictions:
 - 0 – 4999 : 2 bytes per Registers
 - 5000 – 6999: 4 bytes Integers
 - 7000 – Higher: 4 bytes Floating Point
 the Modicon protocol always uses 4 registers.
- **Data Type:** Bit when Status is defined, Integer (16 bit or 32 bit) or Float when Register is defined.
- **Parameter ID:** Instruction set which is available in EnCal 3000. See next pages for complete list.
- **Channel:** This column is reserved to define channel # or stream #, depending on the type of Parameter ID defined.
- **Peak #:** Component number, if applicable.

Note: If components are added, changes must be made in the Modbus list to, submit the results of all components to a controller or flow computer. For the controller type gas-net EnCal 3000 a standard ModBus list is used, which contains up to 26 readable components.

4.8 Generation of reports (Report)

Reports can be created in the **Report** menu on the screen and print it out. The amount depends on the application and the number of components increases accordingly.

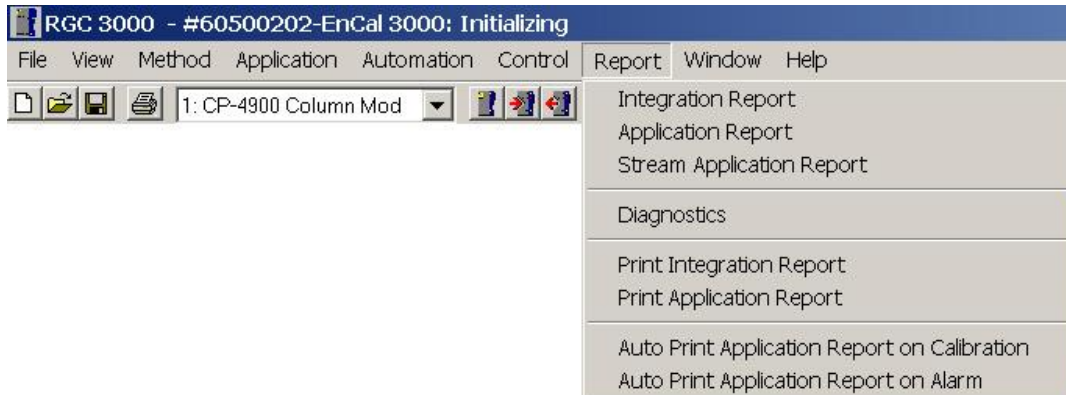

Integration Report gives details on the component analysis. It is only used for tests and diagnostics.

#	Channel	Peak #	Peakname	ESTD Conc.	Retention [s]	PeakRRT [s]	Area	Height	Width[s]	Sepa.Code	Validation	Pk Start [s]	Pk End [s]	Assymety %	Used RF	IniRF Alarm	CurRF Alarm
1	1	1	Nitrogen	3,996900	5,97	0,0000	49513,8111	5463670,7454	0,5101	BV	0	4,90	6,93	1,0732	8,07229E-5		
2	1	2	Methane	88,893700	7,71	0,0000	925697,8401	57944446,1729	0,8912	VB	0	6,93	11,06	2,5198	9,60289E-5		
3	1	3	CO2	1,502600	20,03	0,0000	22143,2796	664857,6117	1,8760	BB	0	16,70	23,85	1,0567	6,78581E-5		
4	1	4	Ethane	4,003000	32,97	0,0000	63530,6756	1214006,2800	2,9413	BB	0	28,23	39,00	1,0976	6,30089E-5		
5	2	5	Propane	1,001600	12,38	0,0000	55851,5291	6701271,7125	0,4881	BB	0	11,79	13,14	1,0800	1,79333E-5		
6	2	6	i-Butane	0,200800	14,62	0,0000	13161,2786	1395326,3027	0,5396	BB	0	13,86	15,48	0,9992	1,52569E-5		
7	2	7	n-Butane	0,201000	16,36	0,0000	13933,4059	1384374,0681	0,5637	BV	0	15,51	16,96	1,0543	1,44258E-5		
8	2	8	neo-Pentane	0,050000	17,25	0,0000	3166,9130	304598,5274	0,6314	VB	0	16,96	18,35	1,6758	1,57882E-5		
9	2	9	i-Pentane	0,049900	22,29	0,0000	3752,4623	278968,5323	0,7595	BB	0	21,09	23,76	1,0091	1,32979E-5		
10	2	10	n-Pentane	0,050100	25,15	0,0000	3844,3802	282499,6063	0,7685	BB	0	23,76	26,46	1,0159	1,30320E-5		
11	2	11	n-Hexane	0,050400	44,71	0,0000	4411,3769	208259,2481	1,1940	BB	0	42,39	47,25	1,0120	1,14250E-5		
12	2	12	?	0,000239	54,64	0,0000	20,9421	773,6555	1,6910	BB	0	52,00	56,06	1,2355	1,14250E-5		
13	2	13	?	0,000191	80,45	0,0000	16,7472	267,1238	5,3552	BB	0	78,97	85,21	2,5750	1,14250E-5		
14	2	14	?	0,000118	146,20	0,0000	10,3256	263,3397	1,7033	BB	0	143,66	147,38	0,9630	1,14250E-5		

Screen Display Integration Report

RGC 3000 Integration report

Integration Report file: c:\RGC 3000\60700235\Data\UpiTemp.pdat
 UserName: admin
 Print date: 02.Okt.2012 15:23

#	Channel	Peak #	Peakname	ESTD Conc.	Retention [s]	PeakRRT[s]	Area [x10nV-S]	Height [x10nV]	Width[s]	Sep.Code	Validation	Pk Start[s]	Pk End[s]	Asym %	Used RF
1	1	1	Nitrogen	3,996900	5,97	0,0000	49513,8111	5463670,7454	0,5101	BV	0	4,90	6,93	1,0732	8,07229E-5
2	1	2	Methane	88,893700	7,71	0,0000	925697,8401	57944446,1729	0,8912	VB	0	6,93	11,06	2,5198	9,60289E-5
3	1	3	CO2	1,502600	20,03	0,0000	22143,2796	664857,6117	1,8760	BB	0	16,70	23,85	1,0567	6,78581E-5
4	1	4	Ethane	4,003000	32,97	0,0000	63530,6756	1214006,2800	2,9413	BB	0	28,23	39,00	1,0976	6,30089E-5
5	2	5	Propane	1,001600	12,38	0,0000	55851,5291	6701271,7125	0,4881	BB	0	11,79	13,14	1,0800	1,79333E-5
6	2	6	i-Butane	0,200800	14,62	0,0000	13161,2786	1395326,3027	0,5396	BB	0	13,86	15,48	0,9992	1,52569E-5
7	2	7	n-Butane	0,201000	16,36	0,0000	13933,4059	1384374,0681	0,5637	BV	0	15,51	16,96	1,0543	1,44258E-5
8	2	8	neo-Pentane	0,050000	17,25	0,0000	3166,9130	304598,5274	0,6314	VB	0	16,96	18,35	1,6758	1,57882E-5
9	2	9	i-Pentane	0,049900	22,29	0,0000	3752,4623	278968,5323	0,7595	BB	0	21,09	23,76	1,0091	1,32979E-5
10	2	10	n-Pentane	0,050100	25,15	0,0000	3844,3802	282499,6063	0,7685	BB	0	23,76	26,46	1,0159	1,30320E-5
11	2	11	n-Hexane	0,050400	44,71	0,0000	4411,3769	208259,2481	1,1940	BB	0	42,39	47,25	1,0120	1,14250E-5
12	2	12	?	0,000239	54,64	0,0000	20,9421	773,6555	1,6910	BB	0	52,00	56,06	1,2355	1,14250E-5
13	2	13	?	0,000191	80,45	0,0000	16,7472	267,1238	5,3552	BB	0	78,97	85,21	2,5750	1,14250E-5
14	2	14	?	0,000118	146,20	0,0000	10,3256	263,3397	1,7033	BB	0	143,66	147,38	0,9630	1,14250E-5

Print out of Integration report

Application Report gives the complete analysis, with calculated data and stream information, and is the report normally used by the operator.

Application Report

SAMPLE		ENERGY		ENVIRONMENT	
Sampling Time	20/09/2012 17:29:58	Calc.Method	ISO 6976	Sampling Analog #1	0.0000
Run Number	26	Compressibility	1.00000	Sampling Analog #2	0.0000
Run Type	Analysis	Molar Mass	18,07313	Cabinet Temperature	37
Calibration Level	0	Molar Mass Ratio	0.62402	Ambient Pressure	100
Stream #	1	Rel.Density	0.62365	Digital in #1	0
Sum ESTD	100,0005	Abs.Density	0,80633	Digital in #2	0
Sum Estimates	0,0000	Hs	11,14188	Digital in #3	0
Sum Areas	1159054,9674	Hi	10,06183		
Total Peaks	26	Wobbe Sup.	14,10876		
Is Startup Run	False	Wobbe Inf.	12,74110		
Unknown Peaks	3				
Current Stream #	7				

#	Channel	Peakname	ESTD Conc.	Norm. Conc.	Retention [s]	Area	Height	Meth-Index	Group#	R.F.
1	1	Nitrogen	3,996900	3,996878	5,97	49513,8111	5463670,7454	1	0	8,072293E-05
2	1	Methane	88,893700	88,893212	7,71	925697,8401	57944446,1729	2	0	9,602885E-05
3	1	CO2	1,502600	1,502592	20,03	22143,2796	664857,6117	3	0	6,785806E-05
4	1	Ethane	4,003000	4,002978	32,97	63530,6756	1214006,2800	4	0	6,300893E-05
5	2	Propane	1,001600	1,001595	12,38	55851,5291	6701271,7125	5	0	1,793326E-05
6	2	i-Butane	0,200800	0,200799	14,62	13161,2786	1395326,3027	6	0	1,525688E-05
7	2	n-Butane	0,201000	0,200999	16,36	13933,4059	1384374,0881	7	0	1,442576E-05
8	2	neo-Pentane	0,050000	0,050000	17,25	3166,9130	304598,5274	8	0	1,578825E-05
9	2	i-Pentane	0,049900	0,049900	22,29	3752,4623	278968,5323	9	0	1,329793E-05
10	2	n-Pentane	0,050100	0,050100	25,15	3844,3802	282499,6063	10	0	1,303201E-05
11	2	n-Hexane	0,050949	0,050948	44,71	4411,3769	208259,2481	11	0	1,1425E-05
12	2	n-Heptane	0,000000	0,000000	0,00	0,0000	0,0000	12	0	0
13	2	n-Octane	0,000000	0,000000	0,00	0,0000	0,0000	13	0	0
14	2	n-Nonane	0,000000	0,000000	0,00	0,0000	0,0000	14	0	0
15	2	n-Decane	0,000000	0,000000	0,00	0,0000	0,0000	15	0	0
16	2	Benzene	0,000000	0,000000	0,00	0,0000	0,0000	16	0	0
17	2	Cyclohexane	0,000000	0,000000	0,00	0,0000	0,0000	17	0	0
18	2	Methylcyclohexane	0,000000	0,000000	0,00	0,0000	0,0000	18	0	0
19	2	Toluene	0,000000	0,000000	0,00	0,0000	0,0000	19	0	0
20	2	n-Undecane	0,000000	0,000000	0,00	0,0000	0,0000	20	0	0
21	2	n-Dodecane	0,000000	0,000000	0,00	0,0000	0,0000	21	0	0
22	2	H2S	0,000000	0,000000	0,00	0,0000	0,0000	22	0	0
23	2	COs	0,000000	0,000000	0,00	0,0000	0,0000	23	0	0
24	2	Oxygen	0,000000	0,000000	0,00	0,0000	0,0000	24	0	0
25	2	Hydrogen	0,000000	0,000000	0,00	0,0000	0,0000	25	0	0
26	2	Helium	0,000000	0,000000	0,00	0,0000	0,0000	26	0	0

Screen Display Application Report

RGC 3000 Application report

Application report file: c:\RGC 3000\60700235\Data\UplTemp.pdat
 UserName: admin
 Print date: 02.Okt.2012 15:21

SAMPLE		ENERGY		ENVIRONMENT	
Sampling Time	20/9/2012 17:29:58	Calc.Method	ISO 6976	Sampling Analog #1	0,0000
Run Number	26	Compressibility	1,00000	Sampling Analog #2	0,0000
Run Type	Analysis	Molar Mass	18,07313	Cabinet Temperature	37
Calibration Level	0	Molar Mass Ratio	0,62402	Cabinet Pressure	100
Stream Number	1	Rel.Density	0,62365	Digital in #1	0
Sum ESTD	100,0005	Abs.Density	0,80633	Digital in #2	0
Sum Estimates	0,0000	Hs	11,14188	Digital in #3	0
Sum Areas	1159054,9674	Hi	10,06183		
Total Peaks	26	Wobbe Sup.	14,10876	SITE INFO	
Is Startup Run	False	Wobbe Inf.	12,74110	Customer ID	
Unknown Peaks	3			Instrument Name	EnCal 3000
Current Stream #	7			Serial Number	60700235
				Tag Number	
				Cylinder 1 Tag	

#	Channel	Peakname	ESTD Conc.	Norm. Conc.	Retention [s]	Area	Height	RF
1	1	Nitrogen	3,996900	3,996878	5,97	49513,8111	5463670,7454	8,072293E-05
2	1	Methane	88,893700	88,893212	7,71	925697,8401	57944446,1729	9,602885E-05
3	1	CO2	1,502600	1,502592	20,03	22143,2796	664857,6117	6,785806E-05
4	1	Ethane	4,003000	4,002978	32,97	63530,6756	1214006,2800	6,300893E-05
5	2	Propane	1,001600	1,001595	12,38	55851,5291	6701271,7125	1,793326E-05
6	2	i-Butane	0,200800	0,200799	14,62	13161,2786	1395326,3027	1,525688E-05
7	2	n-Butane	0,201000	0,200999	16,36	13933,4059	1384374,0881	1,442576E-05
8	2	neo-Pentane	0,050000	0,050000	17,25	3166,9130	304598,5274	1,578825E-05
9	2	i-Pentane	0,049900	0,049900	22,29	3752,4623	278968,5323	1,329793E-05
10	2	n-Pentane	0,050100	0,050100	25,15	3844,3802	282499,6063	1,303201E-05
11	2	n-Hexane	0,050949	0,050948	44,71	4411,3769	208259,2481	1,1425E-05
12	2	n-Heptane	0,000000	0,000000	0,00	0,0000	0,0000	0
13	2	n-Octane	0,000000	0,000000	0,00	0,0000	0,0000	0
14	2	n-Nonane	0,000000	0,000000	0,00	0,0000	0,0000	0
15	2	n-Decane	0,000000	0,000000	0,00	0,0000	0,0000	0
16	2	Benzene	0,000000	0,000000	0,00	0,0000	0,0000	0
17	2	Cyclohexane	0,000000	0,000000	0,00	0,0000	0,0000	0
18	2	Methylcyclohexane	0,000000	0,000000	0,00	0,0000	0,0000	0
19	2	Toluene	0,000000	0,000000	0,00	0,0000	0,0000	0
20	2	n-Undecane	0,000000	0,000000	0,00	0,0000	0,0000	0
21	2	n-Dodecane	0,000000	0,000000	0,00	0,0000	0,0000	0
22	2	H2S	0,000000	0,000000	0,00	0,0000	0,0000	0
23	2	COS	0,000000	0,000000	0,00	0,0000	0,0000	0
24	2	Oxygen	0,000000	0,000000	0,00	0,0000	0,0000	0
25	2	Hydrogen	0,000000	0,000000	0,00	0,0000	0,0000	0
26	2	Helium	0,000000	0,000000	0,00	0,0000	0,0000	0

Print out of Application report

5 Quick Start-up

5.1 Introduction

This chapter is meant as a guideline for the operator to start-up the operation of the unit. It uses some of the information already given in the chapters before, but puts them now in a chronological order for a normal start-up procedure. This supposes that the unit is prepared for the actual site conditions, according to the customer's specifications.

Note: The above addresses or mapped or version numbers are just examples, the appearance of the window may also vary slightly. Since the function and the procedure is the same but will not constitute error represents

5.2 Build a connection



Double-click the RGC 3000 icon on your desktop and and fill out the following dialog as shown. (Default Settings) then click OK.

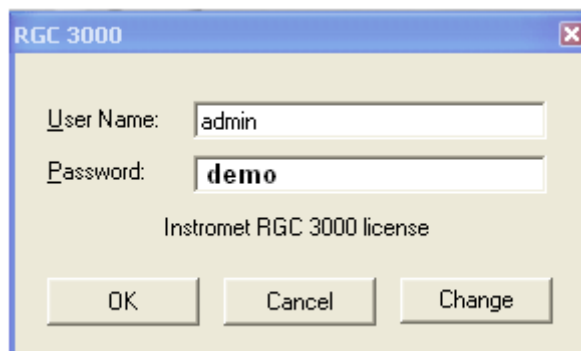

The dialog box titled "RGC 3000" contains the following fields and buttons:

- User Name:
- Password:
- Text: Instromet RGC 3000 license
- Buttons: OK, Cancel, Change

After a message window appeared with the version number for a few seconds, the configuration window will open with an overview of the gas chromatograph, which is set up on the PC.

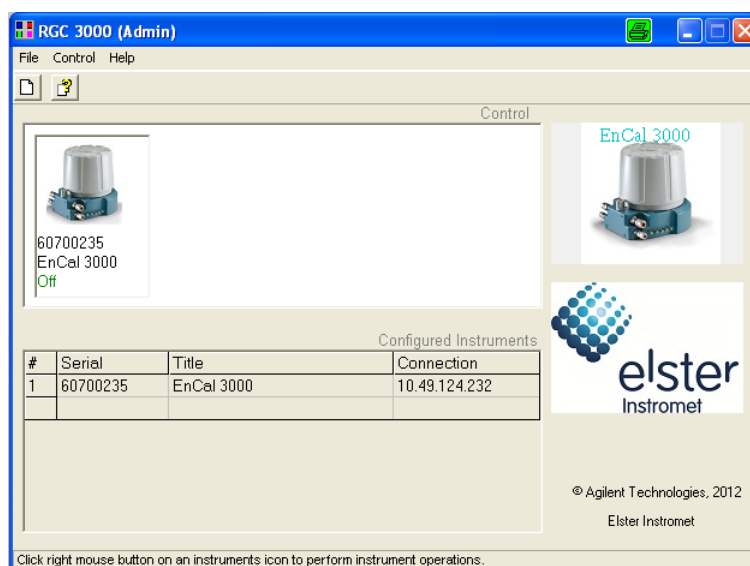

The configuration window titled "RGC 3000 (Admin)" displays the following information:

- Control panel with a unit icon and status: 60700235, EnCal 3000, Off.
- Configured Instruments table:

#	Serial	Title	Connection
1	60700235	EnCal 3000	10.49.124.232

Additional elements include the elster Instromet logo, copyright information (© Agilent Technologies, 2012, Elster Instromet), and a footer instruction: "Click right mouse button on an instruments icon to perform instrument operations."

Double-click the icon of the unit in the field to open RGC 3000.

5.3 Instrument Status

First the status of the unit needs to be checked.
To open **Instrument Status** use the menu shown or click on the highlighted icon.

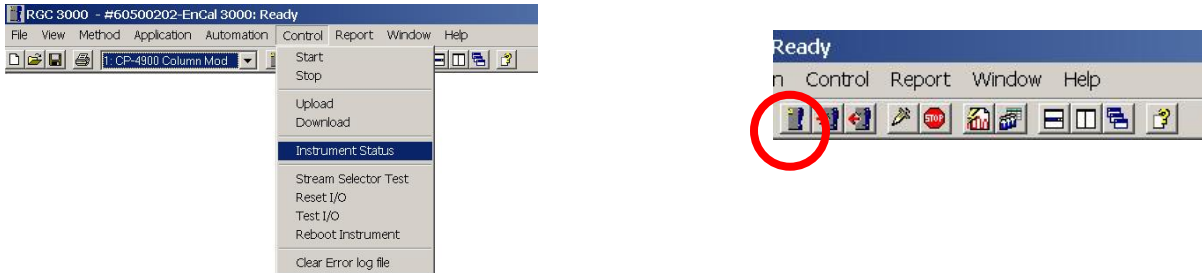

Instrument Status-window has typically the following appearance:

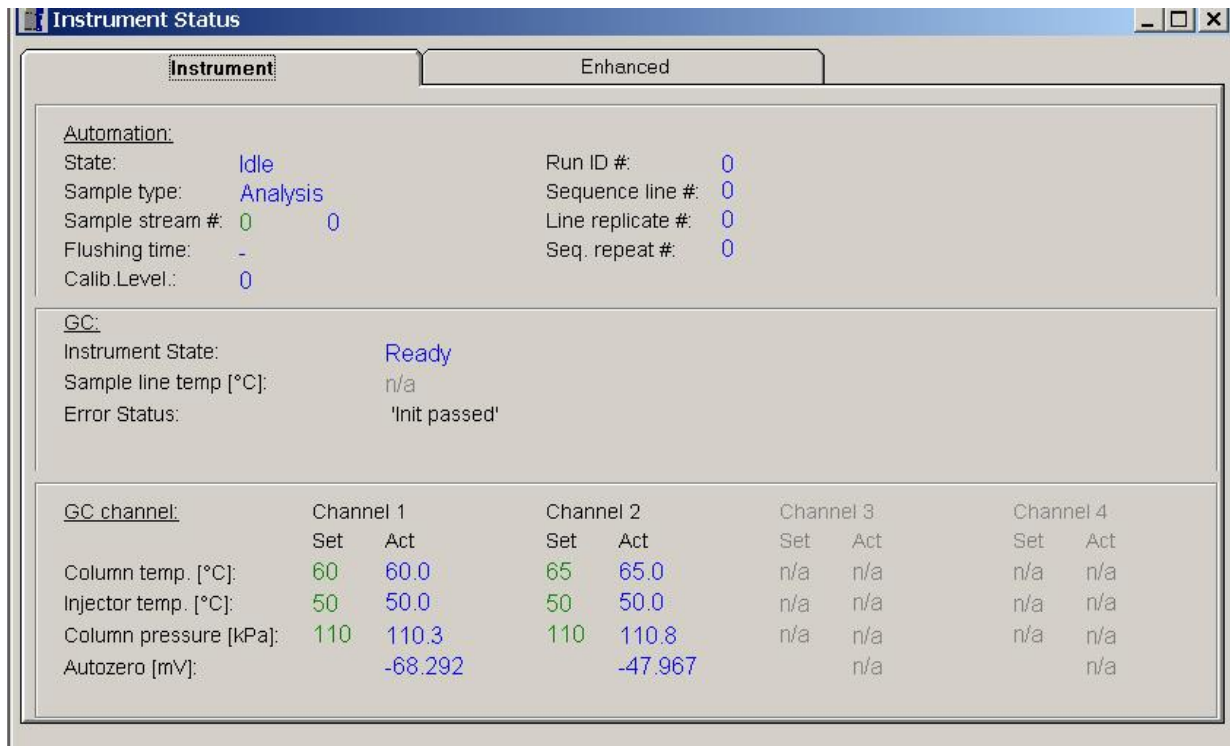

The green colour indicates the user defined set-points. Actual values are displayed in blue in case they are within the internally defined limits of the device, and in red if outside these ranges. The latter case means that the unit is not yet in stable operation conditions (for example injector temperature not yet stable).

Normally stable conditions are reached within 5 minutes.

5.4 Calibration settings

If the gas chromatograph was not supplied with the calibration gas, calibration adjustments must be made. This is done in **Peak Identification** in menu **Method**.

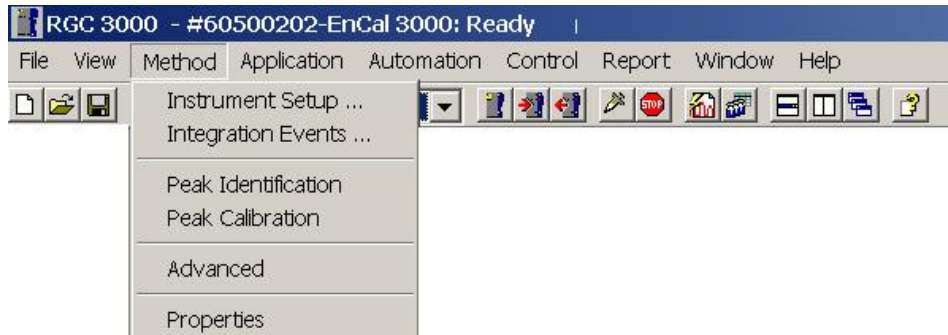

For standard applications, the column level 1 for the concentrations of the calibration gas used.

#	Active	Peak Name	ID	Ret. Time	Rel. Ret. Window	Abs. Ret. Window	Reference	Selection Mode	Rel. Ret. Peak	Level 1	Level 2	Level 3	Level 4	Level 5	Level 6	Level 7	Level 8 Rvw	
1	<input checked="" type="checkbox"/>	Nitrogen	1	5.97086	5	5		0. Nearest		3.9969	0	0					0	3.9969
2	<input checked="" type="checkbox"/>	Methane	2	7.713597	5	5		0. Nearest		88.8937	0	0					0	88.8937
3	<input checked="" type="checkbox"/>	CO2	3	20.02209	5	5		0. Nearest		1.5026	0	0					0	1.5026
4	<input checked="" type="checkbox"/>	Ethane	4	32.9596	5	5		0. Nearest		4.003	0	0					0	4.003

When using a multi-level calibration for daily calibration column level 8 is to use.

Warning: Use only appropriate calibration gases (see Section 4.3 Calibration)

The calibration parameters must be set for all channels. Select the appropriate channel in the header of the RGC 3000 software (as shown below). The menu item **Peak Identification** remains open.



Check also the calibration time in **Automation/ Sequence**, tab sheet **Calibration Properties**:

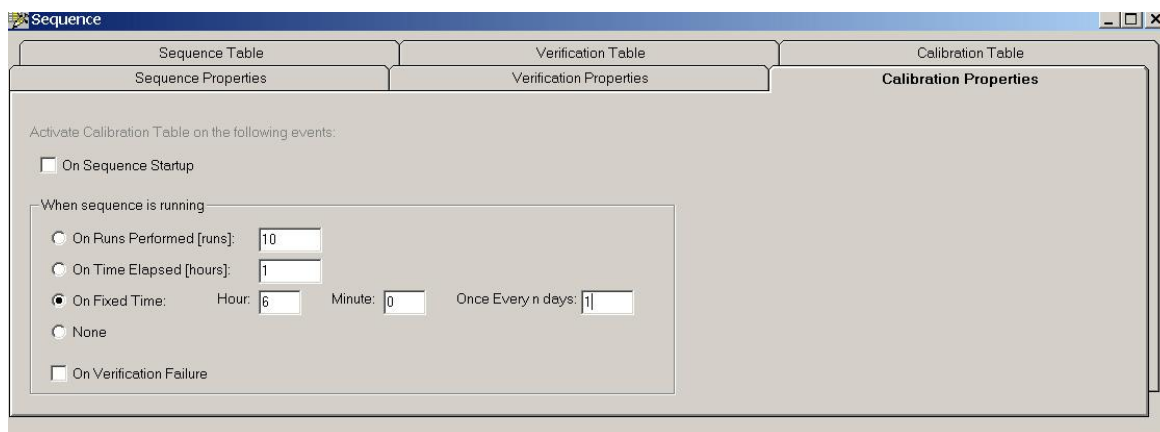

In the above example the unit will be calibrated daily at 6 AM, but this is of course site specific.

Finally check the alarm limits, which are also customer specific.

The alarm settings are defined in **Application / Alarms**

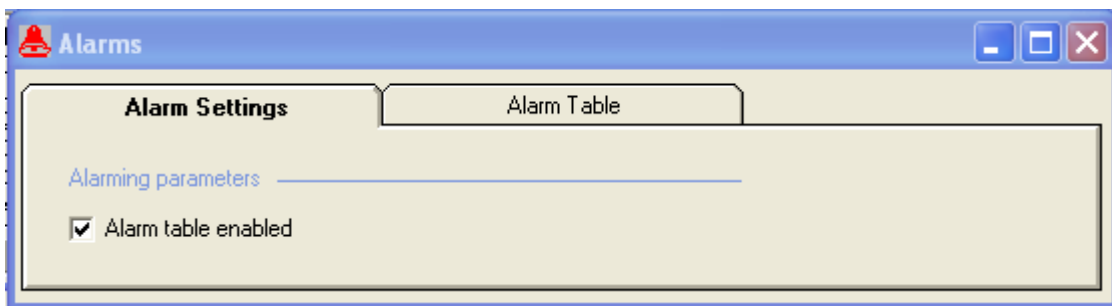
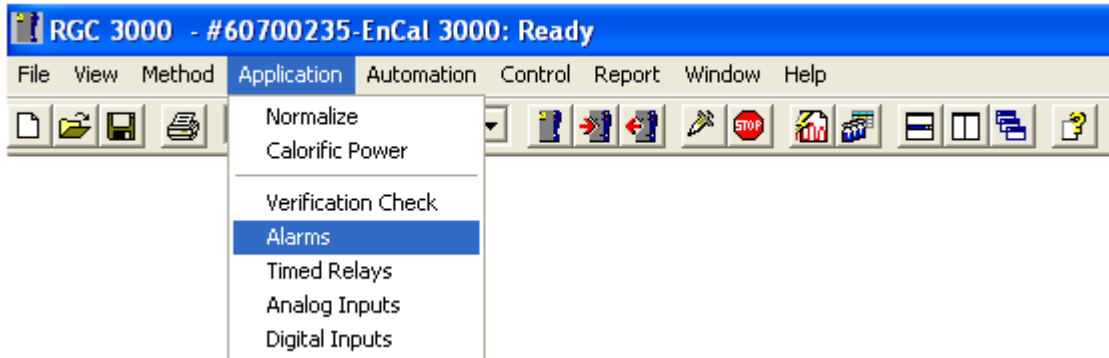
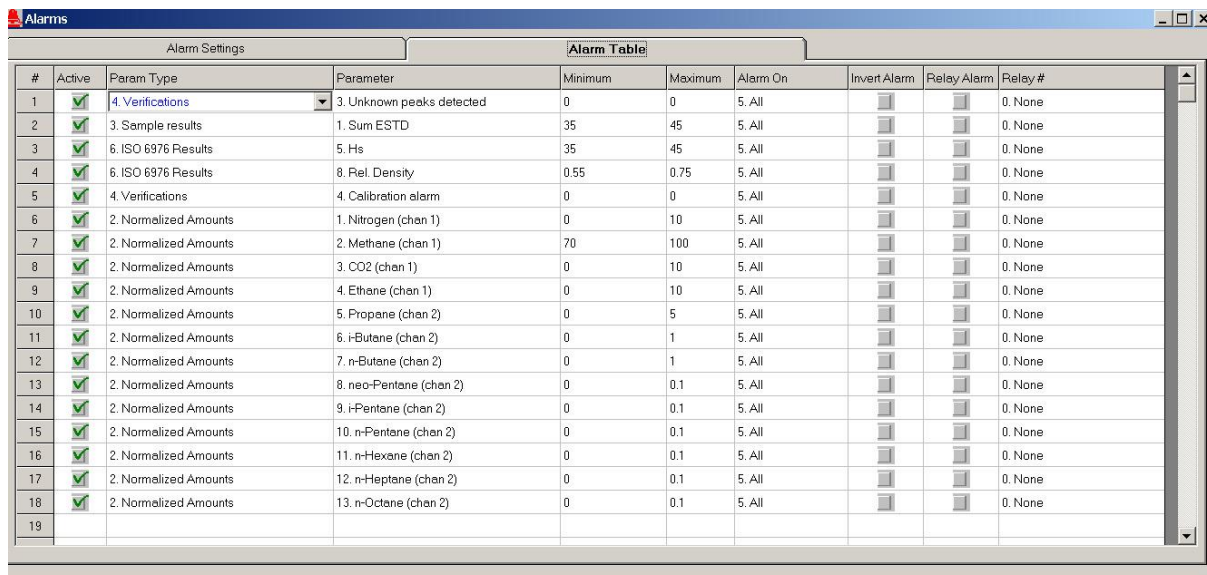
#	Active	Param Type	Parameter	Minimum	Maximum	Alarm On	Invert Alarm	Relay Alarm	Relay #
1	<input checked="" type="checkbox"/>	4. Verifications	3. Unknown peaks detected	0	0	5. All	<input type="checkbox"/>	<input type="checkbox"/>	0. None
2	<input checked="" type="checkbox"/>	3. Sample results	1. Sum ESTD	35	45	5. All	<input type="checkbox"/>	<input type="checkbox"/>	0. None
3	<input checked="" type="checkbox"/>	6. ISO 6976 Results	5. Hs	35	45	5. All	<input type="checkbox"/>	<input type="checkbox"/>	0. None
4	<input checked="" type="checkbox"/>	6. ISO 6976 Results	8. Rel. Density	0.55	0.75	5. All	<input type="checkbox"/>	<input type="checkbox"/>	0. None
5	<input checked="" type="checkbox"/>	4. Verifications	4. Calibration alarm	0	0	5. All	<input type="checkbox"/>	<input type="checkbox"/>	0. None
6	<input checked="" type="checkbox"/>	2. Normalized Amounts	1. Nitrogen (chan 1)	0	10	5. All	<input type="checkbox"/>	<input type="checkbox"/>	0. None
7	<input checked="" type="checkbox"/>	2. Normalized Amounts	2. Methane (chan 1)	70	100	5. All	<input type="checkbox"/>	<input type="checkbox"/>	0. None
8	<input checked="" type="checkbox"/>	2. Normalized Amounts	3. CO2 (chan 1)	0	10	5. All	<input type="checkbox"/>	<input type="checkbox"/>	0. None
9	<input checked="" type="checkbox"/>	2. Normalized Amounts	4. Ethane (chan 1)	0	10	5. All	<input type="checkbox"/>	<input type="checkbox"/>	0. None
10	<input checked="" type="checkbox"/>	2. Normalized Amounts	5. Propane (chan 2)	0	5	5. All	<input type="checkbox"/>	<input type="checkbox"/>	0. None
11	<input checked="" type="checkbox"/>	2. Normalized Amounts	6. i-Butane (chan 2)	0	1	5. All	<input type="checkbox"/>	<input type="checkbox"/>	0. None
12	<input checked="" type="checkbox"/>	2. Normalized Amounts	7. n-Butane (chan 2)	0	1	5. All	<input type="checkbox"/>	<input type="checkbox"/>	0. None
13	<input checked="" type="checkbox"/>	2. Normalized Amounts	8. neo-Pentane (chan 2)	0	0.1	5. All	<input type="checkbox"/>	<input type="checkbox"/>	0. None
14	<input checked="" type="checkbox"/>	2. Normalized Amounts	9. i-Pentane (chan 2)	0	0.1	5. All	<input type="checkbox"/>	<input type="checkbox"/>	0. None
15	<input checked="" type="checkbox"/>	2. Normalized Amounts	10. n-Pentane (chan 2)	0	0.1	5. All	<input type="checkbox"/>	<input type="checkbox"/>	0. None
16	<input checked="" type="checkbox"/>	2. Normalized Amounts	11. n-Hexane (chan 2)	0	0.1	5. All	<input type="checkbox"/>	<input type="checkbox"/>	0. None
17	<input checked="" type="checkbox"/>	2. Normalized Amounts	12. n-Heptane (chan 2)	0	0.1	5. All	<input type="checkbox"/>	<input type="checkbox"/>	0. None
18	<input checked="" type="checkbox"/>	2. Normalized Amounts	13. n-Octane (chan 2)	0	0.1	5. All	<input type="checkbox"/>	<input type="checkbox"/>	0. None
19									

5.5 Sequence settings (ordering)

Check the sequence settings:



The following dialog box appears



Select tab sheet **Sequence Table**:

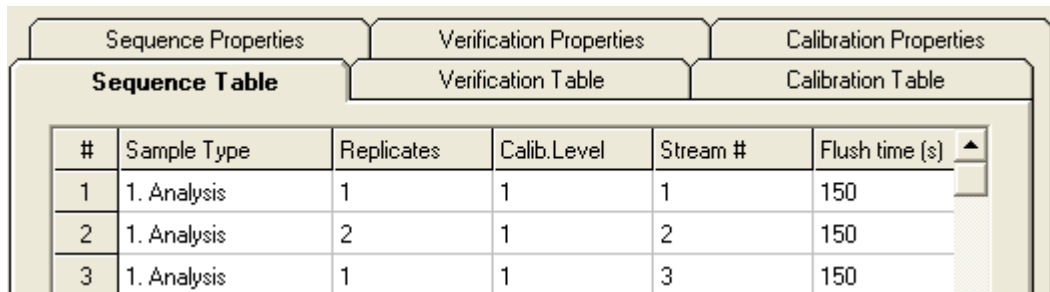

#	Sample Type	Replicates	Calib.Level	Stream #	Flush time (s)
1	1. Analysis	1	1	1	150
2	1. Analysis	2	1	2	150
3	1. Analysis	1	1	3	150

Change the sequence of sample streams according to the site specifications.

5.6 Report settings

If reports need to be generated on hard disk, the parameters which need to be stored need to be selected.

Select **Advanced** in the menu **Method**:

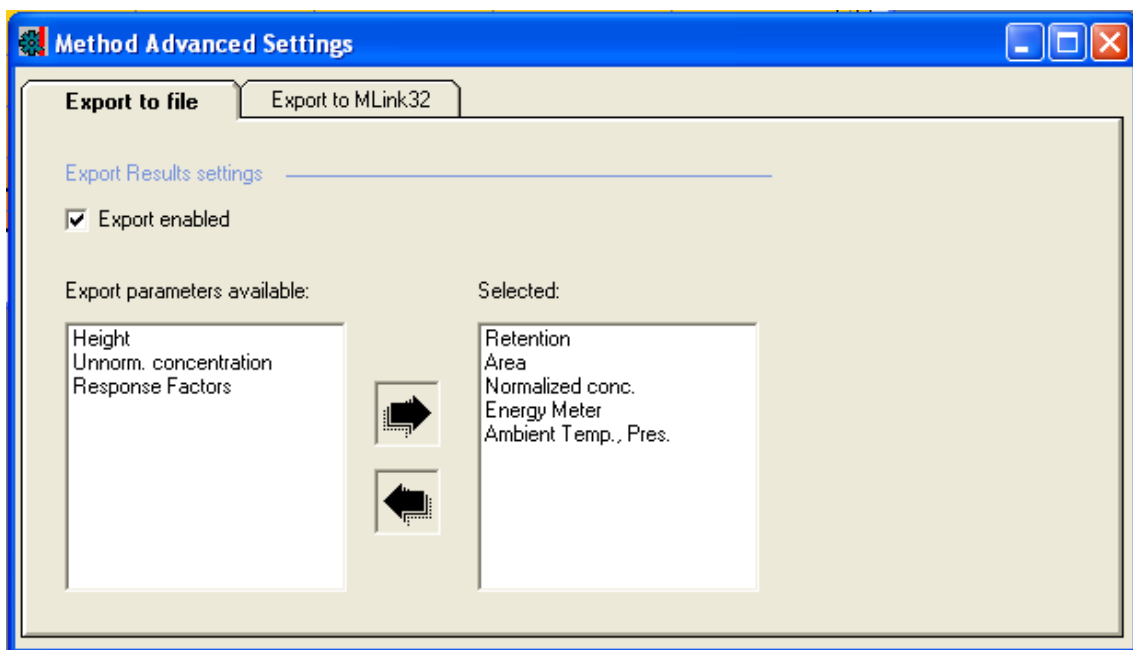
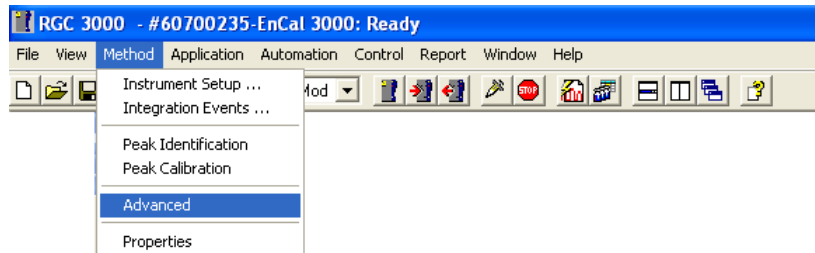

Activate **“Export enabled”** and select the parameters which need to be stored on hard disk with the black arrows.

5.7 Continuous Analysis

The unit is now ready for continuous analysis. Select **Start** in menu **Control** or click the appropriate icon in the toolbar:

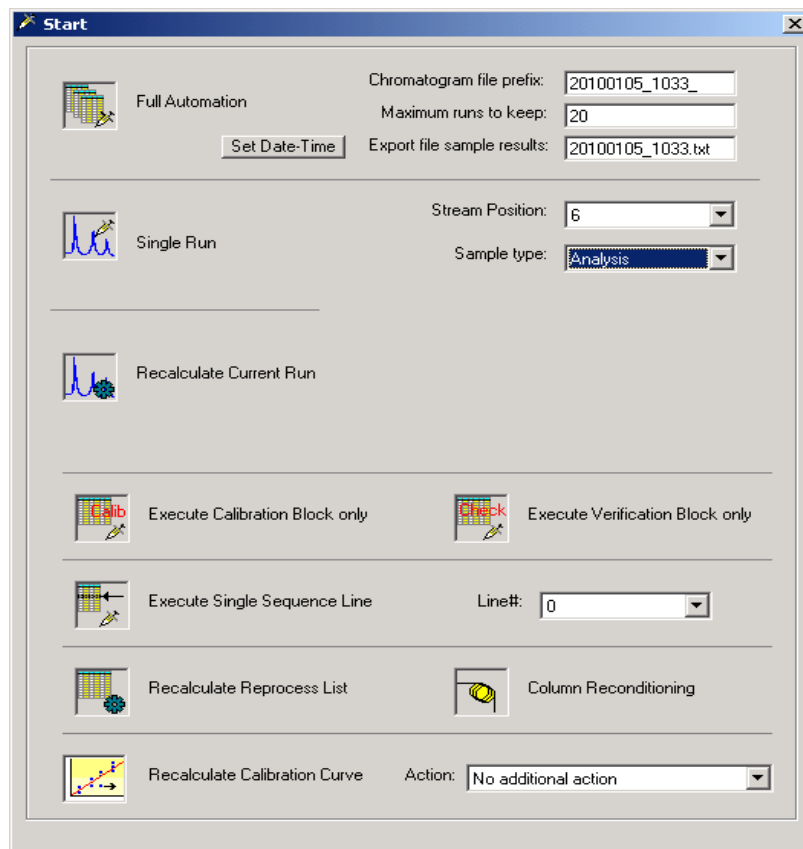
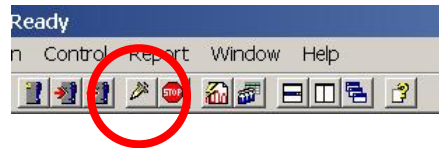
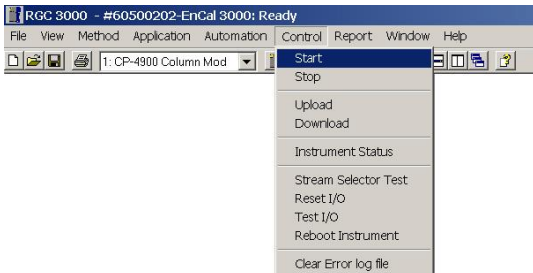

If you want to store the reports on hard disk using RGC3000, make sure to define the settings for the export file:

- | | |
|------------------------------|--------------------------------------|
| Maximum runs to keep: | limited by the size of the hard disk |
| Export file name: | Export file name |

The reports (in ASCII format) will then be stored in the Export directory underneath the directory automatically created on the hard disk for the connected unit, with the serial number of the unit as name.

Select **Full Automation** to start-up continuous analysis.