

EK-87/S

This product is discontinued!

Electronic Volume Corrector EK-87/S Operating Manual and Installation Instructions

Issued 09/97 (c)
Version V1.6

Manual No. 73014986
Edition 7

Changes compared to Issue “b”

- **Software changes:**
 - Update of the DSfG software
(compatible to the specification of 12/96)
 - Flow indication & computation corrected in the DS-100 function
 - Flow limits for Q and Qn (UL and LL) as warning
 - Indication of k-factor now with 6-figures
 - Expansion to 4 MBit EPROM
 - Rectification of slight software errors having no effect for user

- **Changes to the operating manual:**
 - Revision for software version V1.6
 - Correction of errors in the text

All rights reserved

Copyright © 1996 ELSTER Handel GmbH, D-55252 Mainz-Kastel

All details and descriptions in this operating manual and installation instructions have been given only after careful checking. Despite this, errors cannot be completely eliminated. Therefore, no guarantee is given regarding completeness or for the contents. The manual should also not be taken as providing assurance of product characteristics. Furthermore, some characteristics are described in it that are only available as options.

Modifications due to progress in development are reserved. However, we would be very grateful to receive information about errors, etc. or suggestions for improvement.

In relation to the extended product liability, the stated data and material characteristics should only be regarded as guidelines and must always be checked in individual cases and corrected if necessary. This particularly applies where safety aspects are involved.

The passing on and copying of this manual or extracts of it is only permitted with the written agreement of ELSTER Handel.

Mainz-Kastel, 1996

Contents

i	Safety information	8
ii	Included items and accessories	9
1	Brief description	11
1.1	Performance features	11
1.2	Basic formulae	13
2	Operation	15
2.1	Front panel	15
2.2	Keypad	16
2.2.1	Calibration lock and switch	16
2.3	Displays	17
2.3.1	Operating and status displays	17
2.3.2	The list structure	18
2.3.3	Summary charts of EK-87 software structure	19
2.3.4	Procedure for changing values	25
3	Description of functions	27
3.1	Standard volume list	27
3.2	Actual volume list	28
3.3	Pressure sensor list	29
3.3.1	Description of pressure input	30
3.3.2	Adjustment of the pressure input	31
3.3.3	Pressure sensor adjustment	33
3.4	Temperature sensor list	34
3.4.1	Description of temperature input	35
3.4.2	Temperature input adjustment	36
3.4.3	Temperature sensor adjustment	37
3.5	System list	38
3.5.1	DSfG sub-list	39
3.5.1.1	The DSfG interface	40
3.5.1.2	Description of the values in the DSfG sub-list	41
3.5.1.3	Setting up the DSfG interface	43
3.5.1.4	DSfG data element list	44
3.5.3	Display setting sub-list	46
3.5.4	User lock sub-list	47
3.5.4.1	The user lock	47
3.5.5	Accepting parameters	49
3.5.6	DCF-77 Radio Clock	50

3.6	Gas analysis list.....	51
3.6.1	Gas analysis log book	53
3.7	Flow list.....	54
3.8	Gas meter list	55
3.8.1	Pulse input description	56
3.9	Measurement list	59
3.9.1	Freeze function	60
3.9.1.1	Displaying the frozen values.....	60
3.9.1.2	Freeze conditions	60
3.10	Disturbances / log book	62
3.10.1	EK-87 disturbances	62
3.10.2	Volume corrector fault messages	64
3.11	Output list	72
3.11.1	Switching and pulse outputs	74
3.11.2	Analogue outputs (option)	77
3.12	DS-100 function	79
3.12.1	Introduction to the data storage function	79
3.12.2	Display of the value in Channel 1 (V) and Channel 2 (Vn)	81
3.12.3	Display of the values in Channel 3 (p) and Channel 4 (T)	84
3.12.4	DS-100 status register	86
3.12.5	Reading out the consumption data	88
3.12.6	Putting the DS function into operation	89
3.13	Outputting the process data	93
3.14	Value number protocol	95
3.15	IDOM protocol	97
3.15.1	Activating / deactivating the IDOM protocol.....	98
4	Installation	99
4.1	Mounting the EK-87/S	99
4.2	Connecting the cables	99
4.2.1	Cable connection over 50 m	100
4.2.2	Power supply and earthing	100
4.2.3	Pulse generator inputs.....	100
4.2.4	Pressure and temperature sensor inputs.....	100
4.2.5	Switching and pulse outputs	101
4.2.6	Serial interface.....	101
4.3	Layout.....	101
4.4	Wiring diagram	102
4.5	Options	103
4.5.1	Analogue outputs (optional).....	103
4.5.2	DSfG interface (optional)	103
4.5.3	DCF-77 Radio Clock (optional).....	104

4.5.4	S1 Modem Connection (optional)	104
4.6	Sealing diagram	105
5	Check list for setting up	107
6	Maintenance	111
6.1	Battery replacement	111
6.2	Replacing process cards	112
7	Fault handling	113
7.1	Power failure	113
7.2	First aid	114
7.2.1	Checking the input and output cards	114
7.2.1.1	Checking the Analogue Input Card (ExAe2)	114
7.2.1.2	Checking the Pulse Input Card (ExZe4)	115
7.2.1.3	Checking the Digital Output Card (DIA5)	116
7.2.1.4	Checking the Analogue Output Card (AO2/AO4)	116
 Appendices		
A	Certificates	117
A-1	Ex approvals	117
A-2	EC Declaration of Conformance	137
B	Technical data	139
B-1	Mechanical details of EK-87/S	139
B-2	Electrical data EK-87/S	141
B-2a	Serial interface (S1 interface)	143
B-2b	S1 Modem Connection (optional)	143
B-2c	Digital outputs	144
B-2d	Analogue outputs (optional)	146
B-2e	DSfG interface (optional)	147
B-2f	DCF-77 Radio Clock (optional)	147
B-3	Measurement uncertainty of complete unit	148
C	Index	149

i Safety information

The EK-87 can be supplied with mains voltage at 230 V. Take care - mains voltage can be dangerous!

 *Switch on the mains voltage only when all cables have been connected. If the connections are to be modified, it is essential to check that there is no voltage on the device and that it is secured against being switched on again.*

In the device there are modules which are approved as “associated electrical equipment” in Category “ib” according to DIN EN 50020 with intrinsically safe circuits. This means that the EK-87 is suitable for the connection of sensors and pulse generators which are located in areas subject to explosion hazards. The EK-87/S itself must be installed outside the Ex zone.

It is essential to follow the instructions below:

 *Follow the regulations in the relevant standards, in particular DIN VDE 0165.*

 *For the installation and operation of the EK-87 follow the DVGW guidelines for the construction and operation of gas measurement systems as well as the appropriate PTB guidelines.*

 *The EK-87/S must be directly connected to the potential equalisation strips via the earthing screw on the rear panel and a separate cable.*

 *Since the EK-87 connections are freely accessible during operation, it must be ensured that no electrostatic charge (ESD) is present. The operator can discharge himself, for example, by touching the connected potential equalisation strip.*

 *In order to avoid incorrect operation and to prevent problems occurring, it is essential to read the operating manual before operating the EK-87.*

Further information can be taken from the chapter “Installation” in the operating manual.

ii Included items and accessories

a.) Included items

The **EK-87** is supplied complete with pressure and temperature sensors as a calibrated volume corrector and, with exception of the user-specific modes, is parameterised ready for operation.

The following items are included with the EK-87/S:

- EK-87/S Electronic Volume Corrector in 1/2 19" cassette
- Pressure sensor with hardware parts (see packing slip)
- Temperature sensor with accessories
- Operating manual
- Short-form instructions (plastic card)
- Phoenix connector and cable housing with sealing screws for:
Analogue and pulse inputs (8-pole), pulse output (8-pole + 4-pole)
- Design data book for all EK-87 parameters

b.) Ordering information

Designation	Order number
Complete device with p/T sensors	83461810
Basic device (without sensors)	73015001
EK-87/S Operating Manual, English	73014986
Short-Form Instructions, English	73014988
Back-up Battery	04270032
Phoenix Connector, 8-pole	04115270
Phoenix Cable housing, 8 pole	04115275
Phoenix Connector, 4-pole	04115269
Phoenix Cable housing, 4-pole	04115277
Sealing Screws, M2.5 x 10 mm	03534139

c.) Accessories (available options)

Designation	Order number
Analogue Output (2 channels; 0/4-20 mA)	73015166
(4 channels; 0/4-20 mA)	73015566
DSfG Card (compl.)	73015172
Stub Cable (2m)	without ID
Bus Coupler (max. 4 devices)	without ID
DCF-77 - Radio Clock Receiver (compl.)	73015175
Expert Mouse Clock	04407024
Extension Cable (5m)	73014884
S1 Modem Connection (compl.)	73015178
19" Rack	73014809
Replacement boards	
Combination Power Supply	73014525
CPU Board	73014800
Pulse Input Card ExZe4	73013893
Analogue Input Card ExAe2	73013894
Digital Output Card DIA5	73014801
Analogue Output Card AO2	73015097
Analogue Output Card AO4	73013958

1 Brief description

1.1 Performance features

- Electronic system (state) volume corrector.
- Computation of the K value according to **S-GERG-88**, **AGA-NX-19-mod-BR.KORR.3H** or $K=\text{constant}$, selectable in the EK-87.
- LCD display (8mm high; 2x16; with background illumination) and 18-key keypad as operating controls; LED status display for mains, alarm and warning.
- 4-channel **data storage** function (DS-100) for time-referenced storage of the daily/hourly values of standard/actual volume, pressure and temperature; approved for general calibration.

Software functions:

- Ordered list structure with direct-key function for:
 V_n , V , p , T , Z value, K value, Q_n .
- Automatic monitoring of device function and logging of any disturbances that occur (in status register + log book).
- Freeze function for two sets of consumption data dependent on:
Duration (up to 999 min.), consumption (in m^3), time point and time interval.
- Characteristic correction for the pressure/temperature sensor via up to three reference points (can be recorded or entered as a table).
- Two languages selectable in device.
- Volume corrector protocol for recall and, if necessary, modification of all values via the serial interface.
- Printer protocol for outputting certain values (IDOM protocol).

Hardware functions:

Pulse inputs:

- Three **intrinsically safe NAMUR** inputs (DIN 19234): 2x HF (LF), 1x AUX connection from A1S/A1R and E1 sensors.
- Automatic determination of the type of input (HF/LF) or specification by user possible.
- Simple method of sealing.

Analogue inputs:

- Two analogue inputs - designed as intrinsically safe - for the connection of intrinsically safe or flameproof measurement sensor.
- Connection of a Pt100 temperature sensor in four-wire technology.
- Connection of a pressure sensor (absolute or relative with definition of the atmospheric pressure on site) in two-wire technology (4 - 20 mA).

Outputs:

- Five freely configurable switching/frequency outputs; 1x relay changeover contact (alarm default definition) and 4x transistor outputs (default definition as $2x V_n$, $2x V$); electrical isolation to EK-87.
- Serial interface according to RS-232 / V24 for data communications on the front panel.

Mechanical details:

- Constructed as 1/2 19" cassette, 3 height divs., depth 240 mm; ambient temperature: -10...+50°C; IP protection class 20; CE label.
- Power supply: 24 VDC and/or 230 VAC.
- Data back-up of the system settings using EEPROM; retention of the consumption data by back-up battery (service life ≥ 5 years).
- Cable connection via screw terminals; accessible from the back.
- Calibration switch on the front panel with simple method of sealing.

Options:

- Optional: Read-out interface routed to the terminal space (S1M changeover switch for modem connection).
- Optional: 2 or 4 freely programmable analogue outputs (0/4 to 20 mA); electrically isolated to the EK-87.
- Optional: DSfG interface ¹
- Optional: DCF-77 Radio Clock ¹
- 19" rack with blank panels for one or two EK-87s.

¹ either DSfG Card or DCF-77 Radio Clock

1.2 Basic formulae

Actual volume V:

$$V = \frac{N}{c_p}$$

V	=	Actual volume	m ³
N	=	Number of pulses	1
c _p	=	c _p value	1/m ³

Standard V_n:

$$V_n = V \cdot Z$$

V _n	=	Standard volume	m ³
V	=	Actual volume	m ³
Z	=	Correction factor (Z value)	1

Correction factor (Z value):

$$Z = \frac{T_n \cdot p}{T \cdot p_n \cdot K}$$

Z	=	Correction factor	1
T _n	=	Standard temperature	K (273.15 K)
p	=	Actual pressure	bar
T	=	Actual temperature	K
p _n	=	Standard pressure	bar (1.01325 bar)
K	=	Gas law deviation factor	1

Gas law deviation factor (K value):

$$K = \frac{Z}{Z_n}$$

K	=	Gas law deviation factor	1
Z	=	Correction factor	1
Z _n	=	Correction factor at standard conditions	1

According to S-GERG-88 V33, AGA-NX-19-mod-BR.Koo.3H or fixed value.

Standard and actual flow Q_n, Q:

$$Q_n = \frac{\Delta V_{nt}}{\Delta t}$$

Q _n	=	Standard flow	m ³ /h
ΔV _{nt}	=	Tot. standard vol.	m ³
Δt	=	Time interval	h

$$Q = \frac{\Delta V_t}{\Delta t}$$

Q	=	Actual flow	m ³ /h
ΔV _t	=	Tot. actual vol.	m ³
Δt	=	Time interval	h

2 Operation

2.1 Front panel

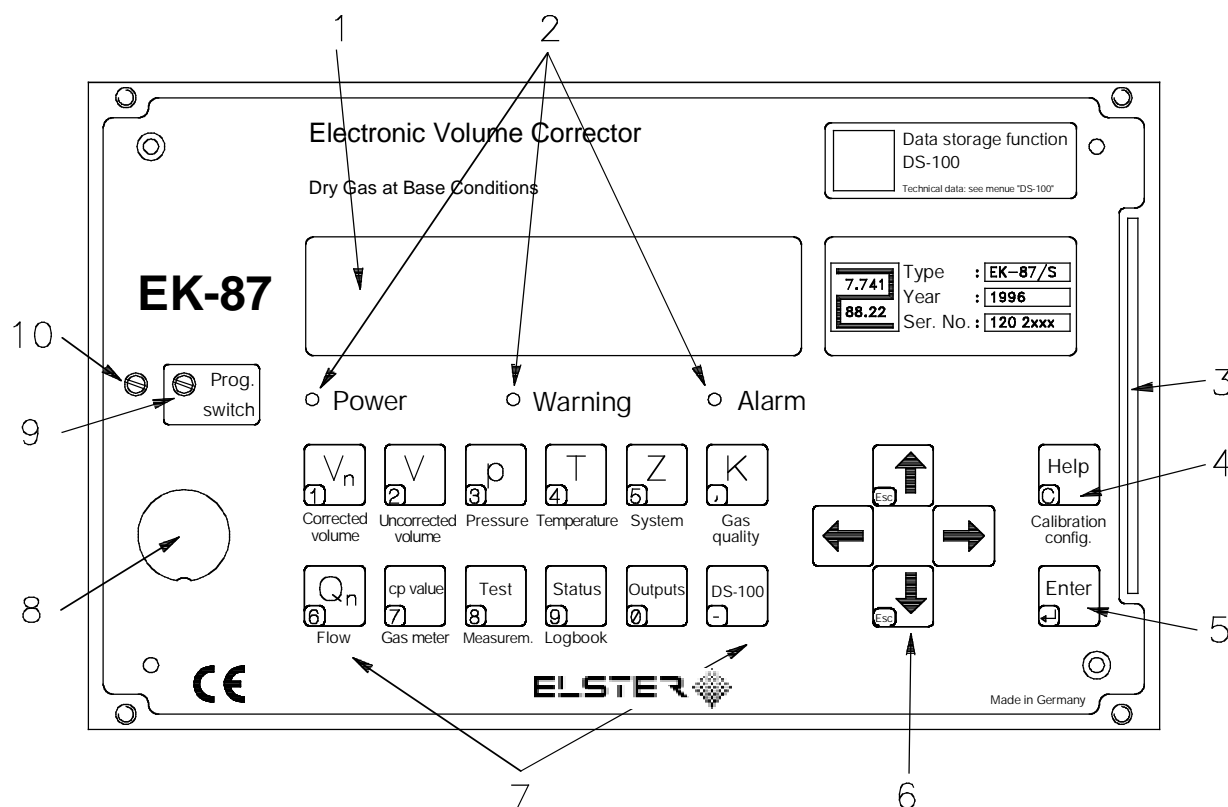

Explanation:

- 1 **LCD display**
2 lines of 16 characters with background illumination
- 2 **Status displays**
3 LEDs for function check
- 3 **Slot for plastic card** (short-form instructions)
- 4 **Help key**
- 5 **Enter key**
- 6 **Cursor keys**
- 7 **Direct selection keys**
- 8 **Read-out interface**
It is possible to read out the DS-100 function consumption data or all the EK-87 values or to set values depending on the calibration switch or user lock.
- 9 **Calibration switch (M3x8 mm capstan screw)**
- 10 **Sealing of calibration switch possible**

See next chapter
for explanation

2.2 Keypad

A membrane keypad with 18 keys is provided as the interface between the operator and the EK-87. The keys are equipped with a “direct selection function” and most of them have another function:

Function of the keys

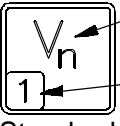
	<p>Direct keys (e.g. V_n key)</p>
<p>1: Direct selection of the value: “Standard volume, undisturbed”</p>	<p>1: Direct selection of the value: “Standard volume, undisturbed”</p>
<p>2: With cursor keys (\uparrow/\downarrow): Skip to “Standard volume list”</p>	<p>2: With cursor keys (\uparrow/\downarrow): Skip to “Standard volume list”</p>
<p>3: In enter mode: Figure “1”</p>	<p>3: In enter mode: Figure “1”</p>



Cursor keys (\uparrow/\downarrow)

Display mode:
In enter mode:

Move up/down in the list
Cancellation of entry



Cursor keys (\rightarrow/\leftarrow)

Display mode:
In enter mode:

Skip to right/left list
Text selection (e.g. selection yes/no)

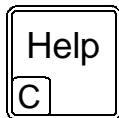

Help key

Display mode:
With cursor keys:
In enter mode:

On-line help for previously displayed value
Calibration list (future feature)
Correction key



Enter key

Display mode:
In enter mode:

Skip to enter mode
Enter termination, return to display mode

2.2.1 Calibration lock and switch

The calibration lock is used to secure parameters which are subject to calibration regulations. The calibration switch for opening and closing the calibration lock is controlled by an M3x8 mm capstan screw located on the front panel. The lock is opened by unscrewing the screw about 3 - 4 mm.

 *It is not necessary to completely unscrew the screw (otherwise there is a risk of losing it)!*

A reminder of an open calibration lock is given in the display by the message “E06 Calibration lock open”. In addition this condition can be interrogated under “Status” (“E06” flashing indicates. “Calibration switch open”) or in the list “System” by pressing “↑” three times (= Status of calibration lock - see Chap. 3.5).

If the lock is closed, the set values are displayed only. Whether a displayed value is subject to calibration regulations can be determined using the **Help** function (labelled (C)).

 *If the calibration lock is closed, the user lock is also automatically closed if the combination has been assigned.*

2.3 Displays

LCD display

Each character is arranged in a 5x7 matrix with cursor (-> alphanumeric representation). The **cursor** indicates the entry mode. It is displayed after selection of the required value and confirmation using the “Enter” key depending on the state of the calibration and user locks.

The LCD is background illuminated (with/without automatic cut-off) and the contrast can be adjusted to local conditions.

Messages are output in plain text and with the usual abbreviations. The designations are generally displayed in the top line, whereas the values are arranged right justified in the bottom line. Each value is displayed with the corresponding unit. In addition there is **on-line help** available. It can be called immediately by pressing the “Help” key in the display mode.

2.3.1 Operating and status displays

Three light emitting diodes provide a quick check of the operating status:

The **Mains** LED indicates that the power supply is working.

The **Alarm** LED indicates that a disturbance affecting the volume correction has occurred (flashing LED = disturbance present; continuous LED = disturbance passed but not yet acknowledged). The programmed substitute values are used and counting takes place in the disturbance volume counter while a disturbance is present. The limit values for an “Alarm” are generally subject to the user lock.

The **Warning** LED indicates that a user-specific quantity has been violated. Counting does not take place in the disturbance volume counter. The limits for a “warning” are subject to the user lock.

2.3.2 The list structure

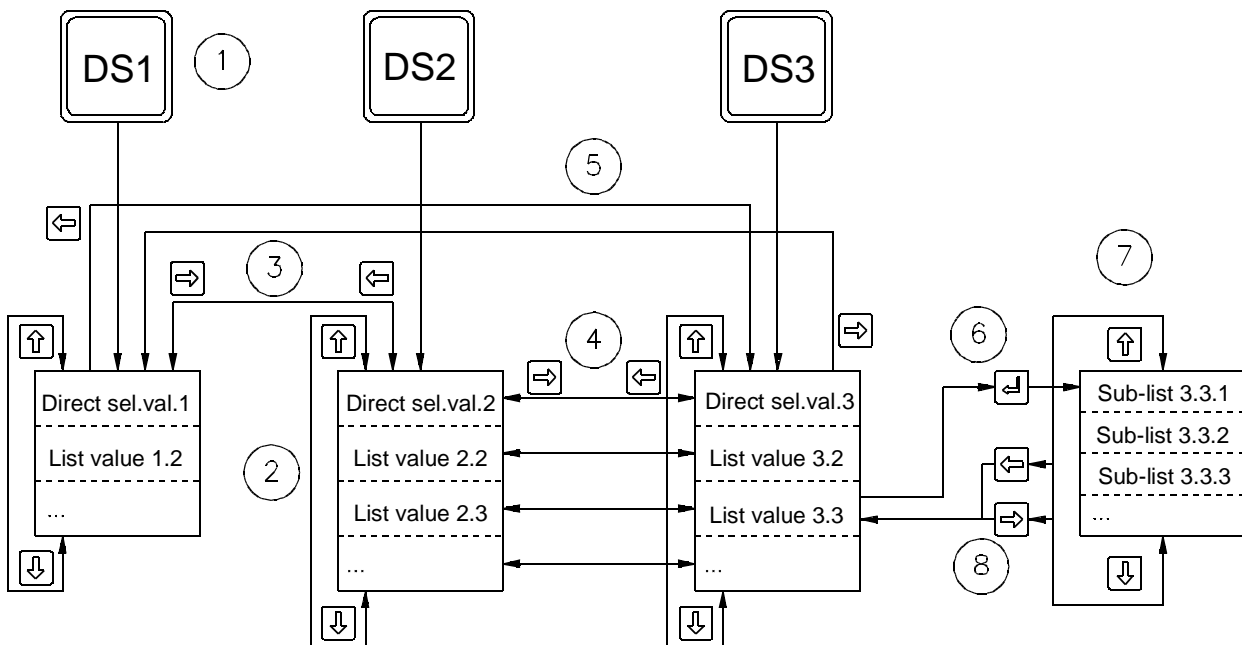

Movement within the list structure

- 1 The key value (= 1st list value) can be directly called in the display mode (without display of the cursor) using the direct keys (e.g. "V_n").
- 2 You can move downwards / upwards in the selected list (at the end of the list to the first value) by using the cursor keys "↓" / "↑".
- 3 You can move from one list to the next using the cursor keys "→" / "←". Normally, up to the first value in the list.
- 4 With directly correlated values (e.g. pressure and temperature) skipping to the corresponding values occurs using "→" / "←" (e.g. p_{max} ↔ T_{max}).
- 5 Skipping from the last list to the first list and vice versa also takes place using the cursor keys "→" / "←".
- 6 Various values are combined within a list to a "sub-list". In the display the start of this type of list is indicated by the "Enter" key (↵). Branching to the sub-list occurs when the "↵" key is pressed.
- 7 You can move within this sub-list using the cursor keys "↓" / "↑" in a manner similar to Point 2.
- 8 You return to the main list using the cursor keys "→" / "←".

2.3.3 Summary charts of EK-87 software structure

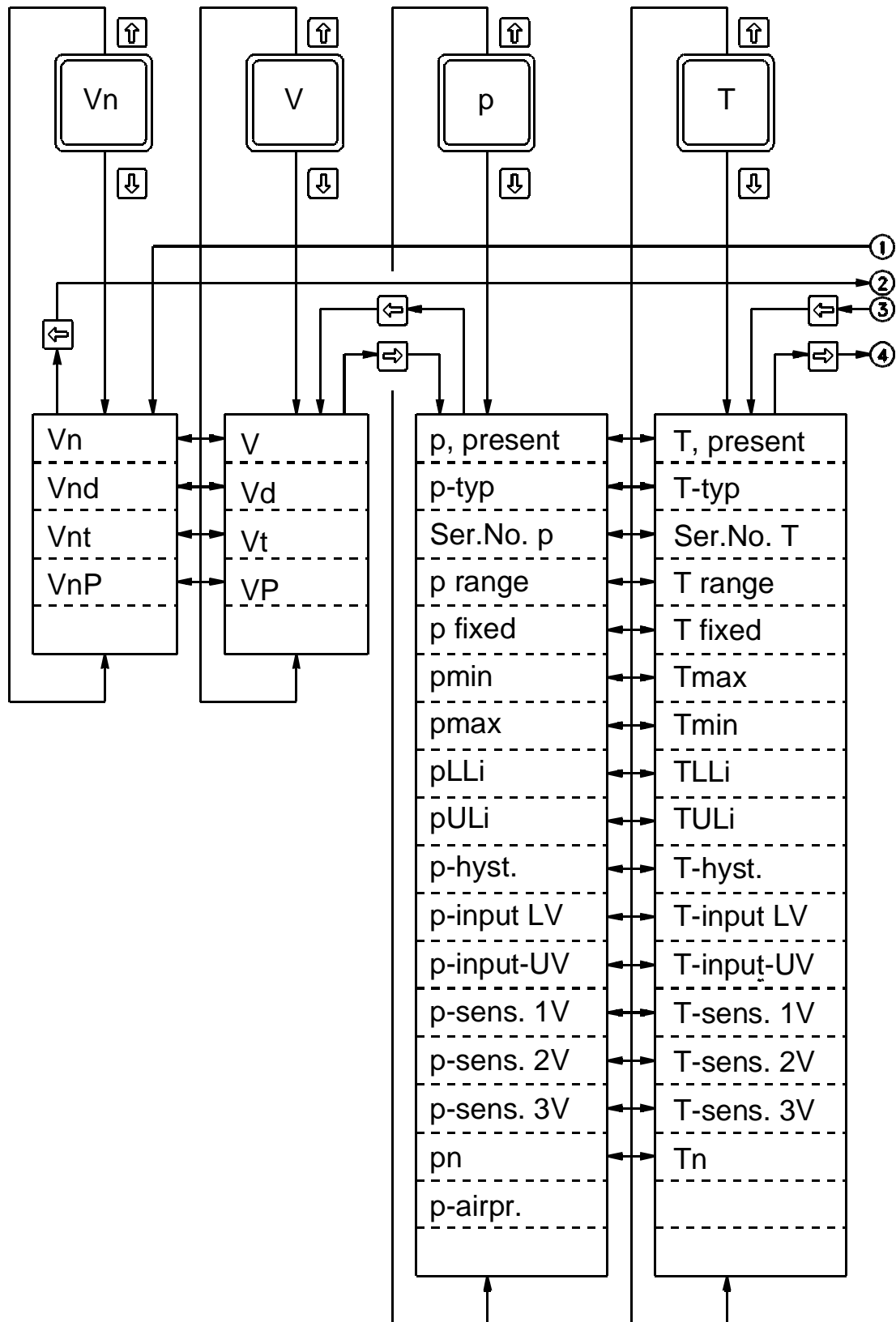

Summary charts of EK-87 software structure (continued)

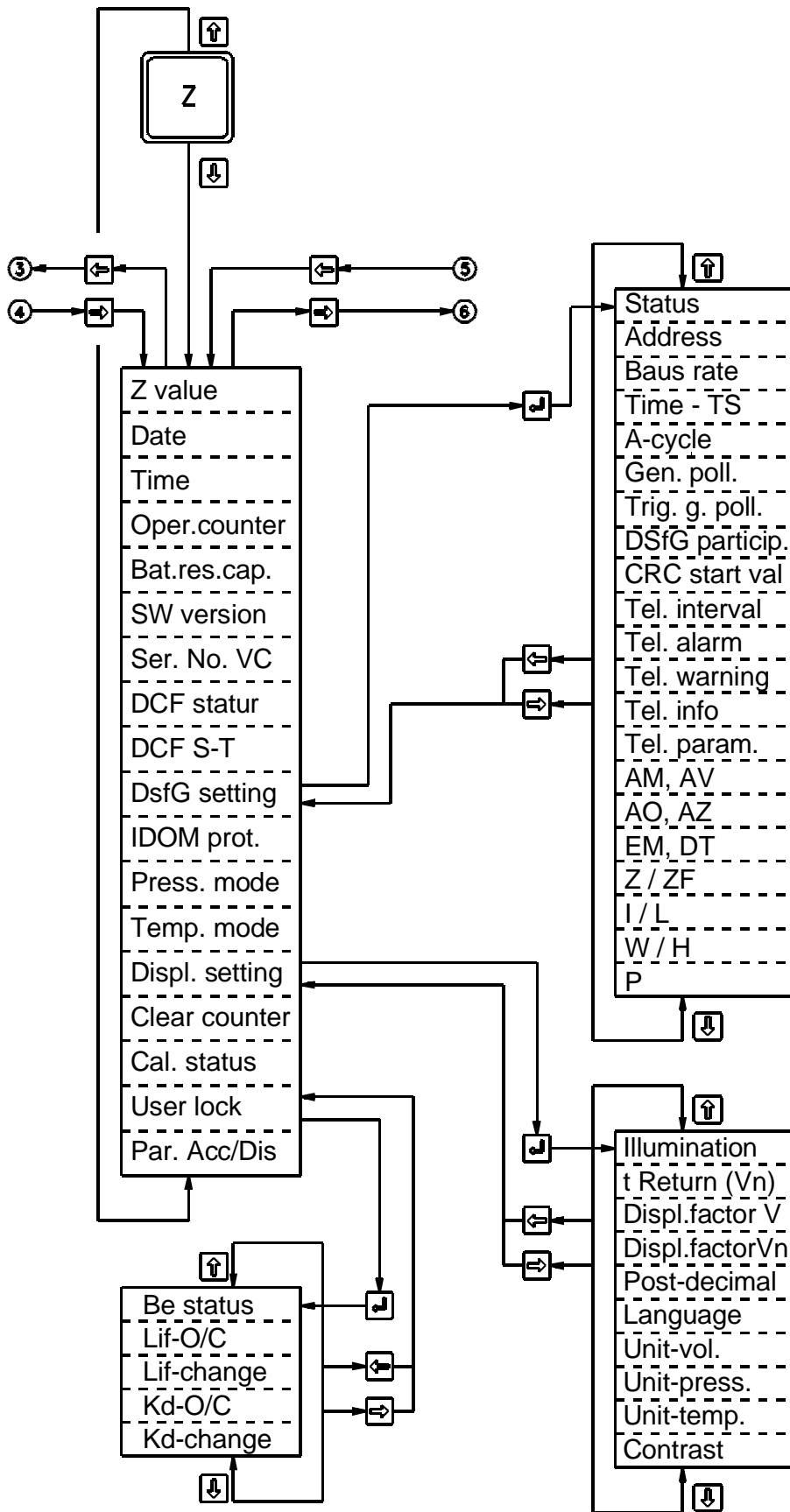

Summary charts of EK-87 software structure (continued)

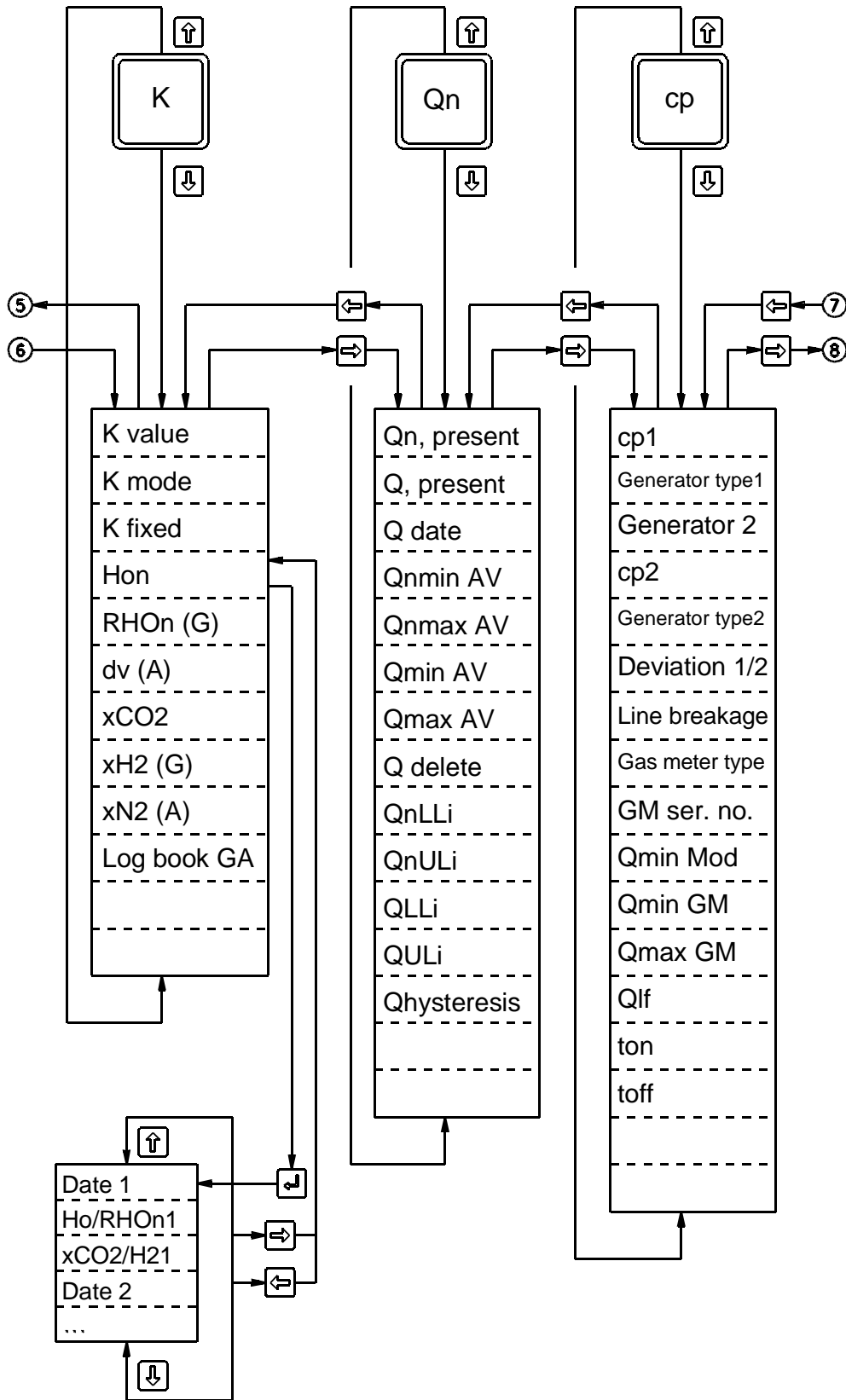

Summary charts of EK-87 software structure (continued)

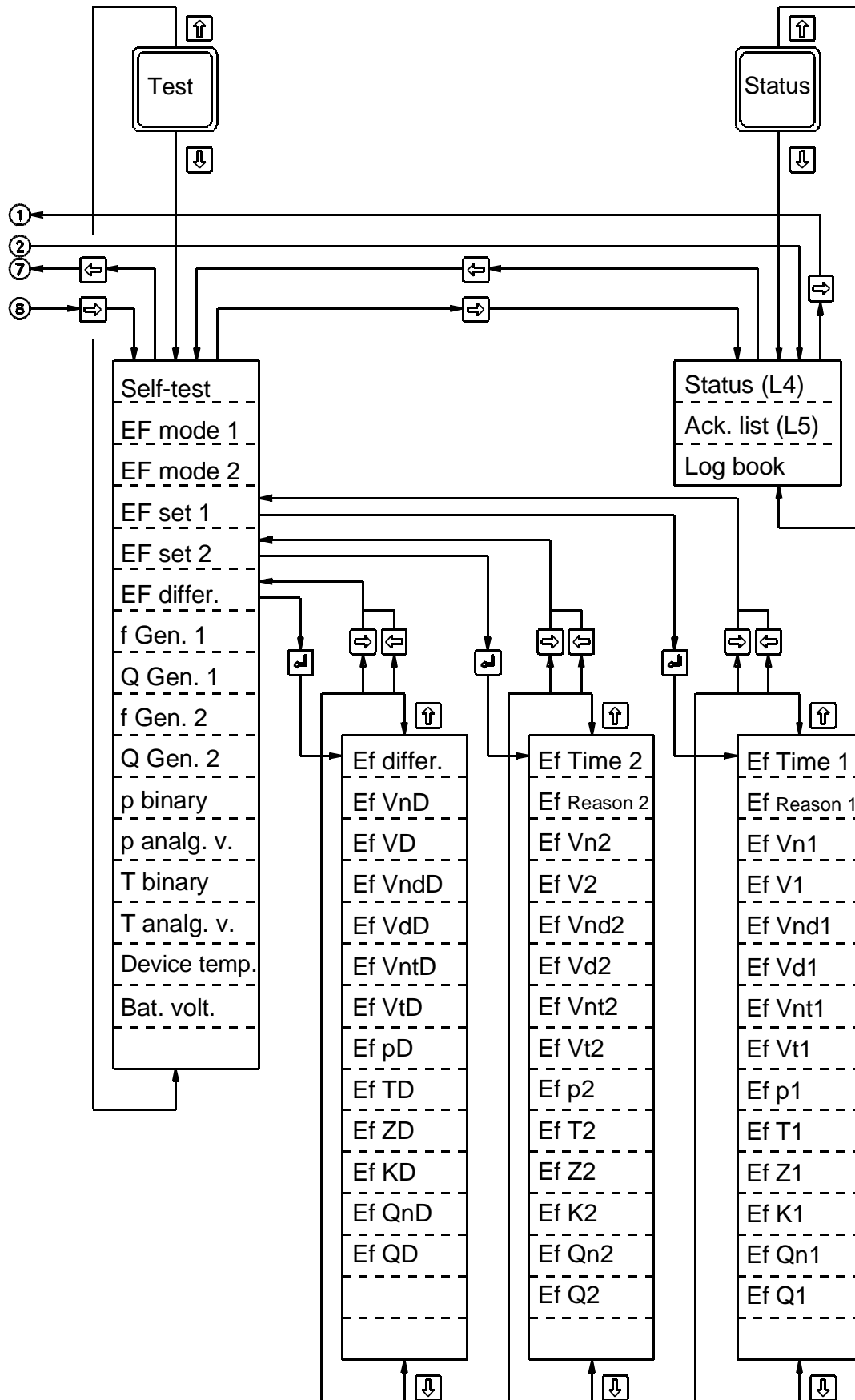

Summary charts of EK-87 software structure (continued)

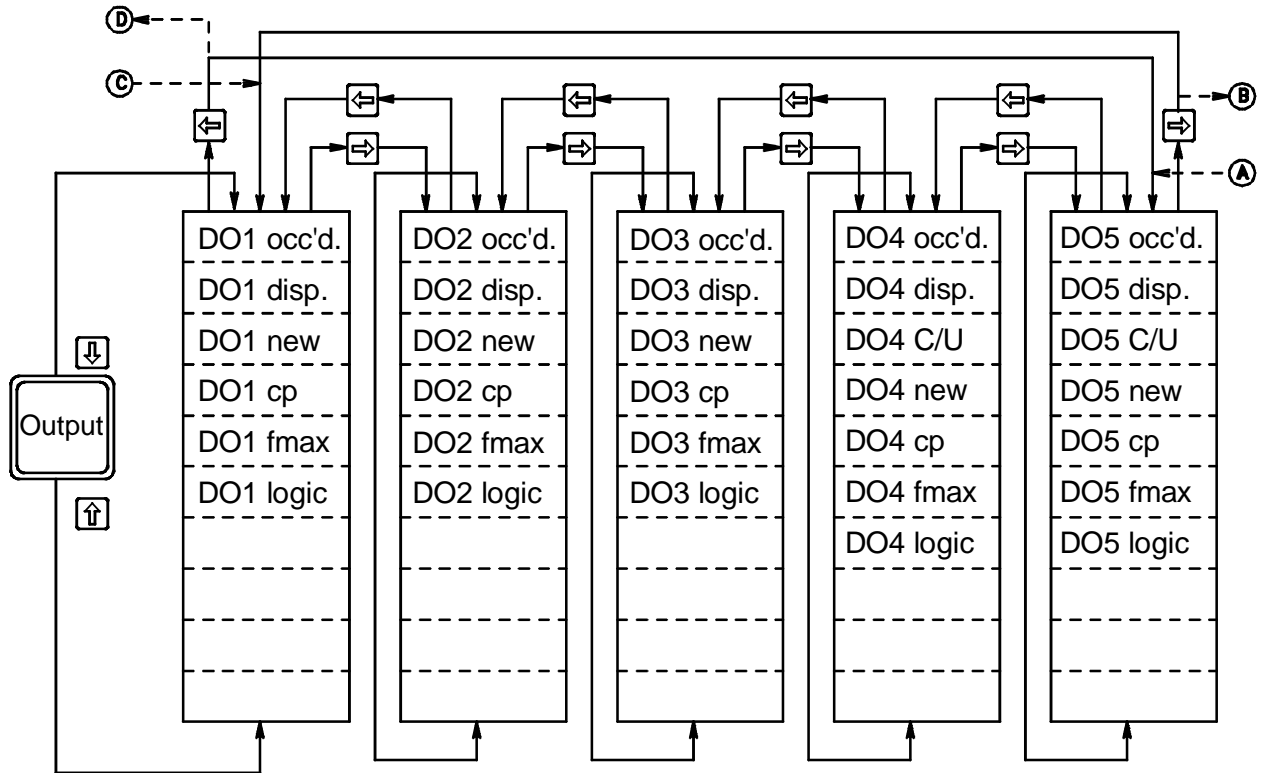

Optional, with AO2 or AO4 card:

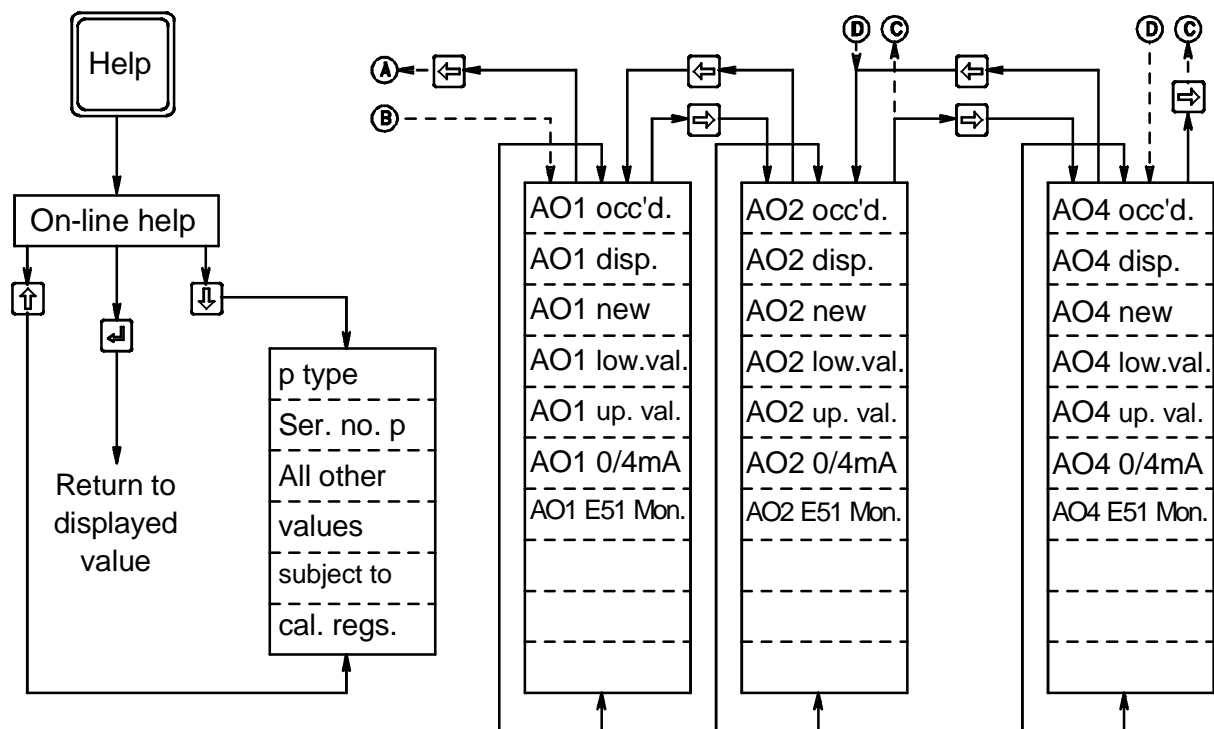

Summary charts of EK-87 software structure (continued)

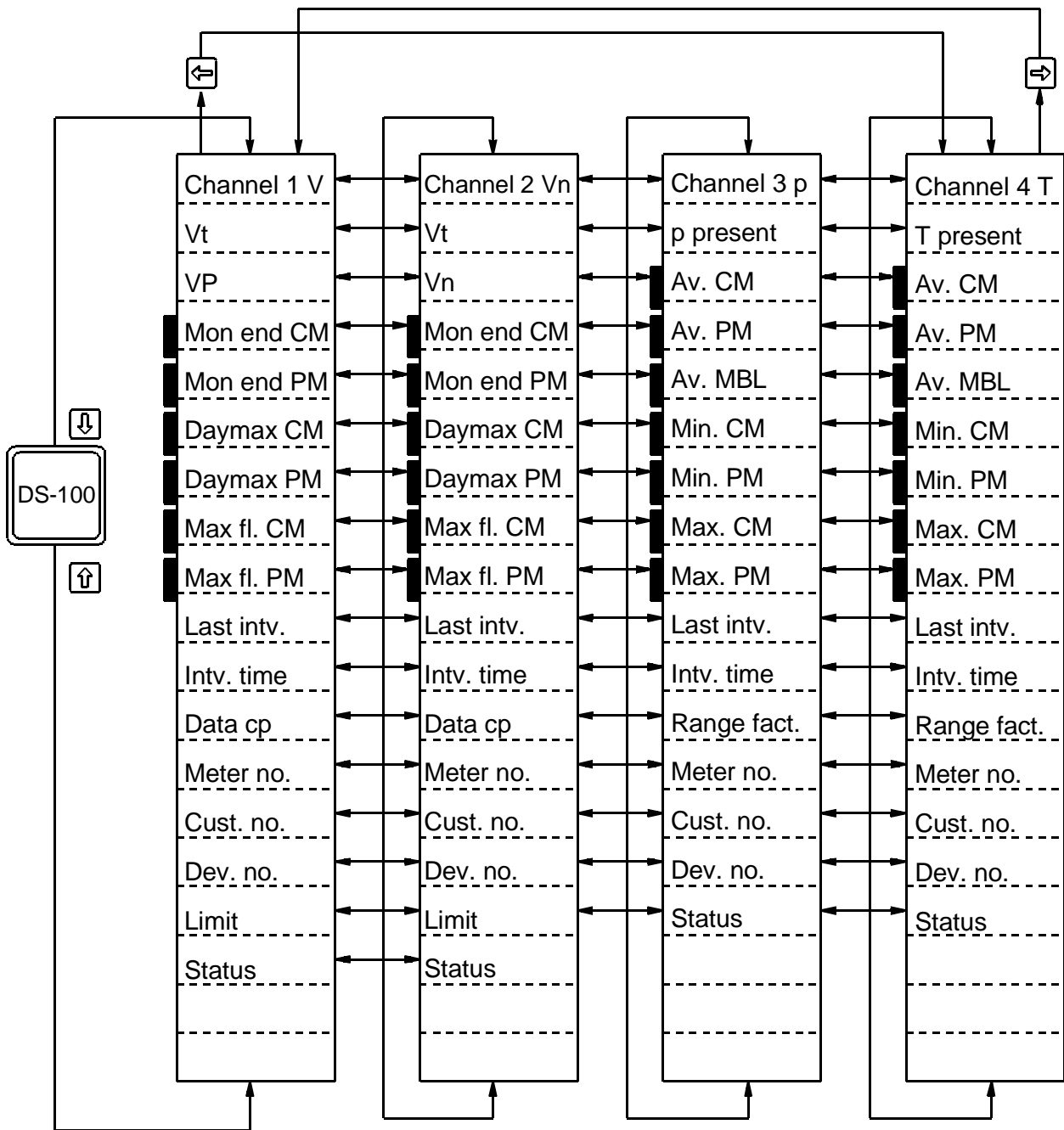

Explanation:

Mon end = Month end reading
 CM = Current month
 PM = Previous month
 Max. fl. = Maximum flow

Daymax = Daily maximum
 PM = Previous month
 MBL = Month before last
 Last intv. = Last interval

2.3.4 Procedure for changing values

The following procedure is required for changing values in the EK-87:

1. Select the required value via the direct selection keys and the cursor keys “↓”/“↑” (see previous chapter).
2. Take note of the state of the calibration and user locks. Whether the value is subject to the calibration or user locks, can be found for each value by pressing the “**Help**” key.
 - (C): Value is subject to the calibration lock.
 - (U): Value is subject to the user lock.
 - (A): Value is subject to access code AS-100 (on in DS-100 function).
3. If necessary, open lock:
 - Calibration lock: See Chap. 2.2.1 - **IMPORTANT:** Calibration official required.
 - User lock: See Chap. 3.5.3 - Supplier and, where applicable, customer are required.
 - Access code: See AS-100/AS-200 Operating Manual.
4. Once the required locks have been opened, the value can be changed. To do this, call the **enter mode** with the “Enter” key. A **cursor** appears below the value to be changed.
5. In the entry mode the direct keys have the function represented by the character shown at the lower left. The entry of figures is therefore also possible. Text (such as “yes”/“no”) or permanently defined terms such as “2088” or “1151 AP” are selected using the cursor key “→” or “←”.
6. With an incorrect entry the last figure of the input can be restored with the key “C” or the entry completely cancelled with the cursor keys “↓” / “↑”, returning to the display mode.
7. The valid value range for entries is immediately checked and acceptance denied where applicable. A correct value entry is then terminated with the “Enter” key and you are returned to the display mode.

 ***After termination of the entry, operation usually does not take place with the new values (exception e.g. time of day), but instead it is essential that the changes are “accepted”. The new and old values flash alternately in the display (new value 2 sec., old value 1 sec.) in order to indicate to the user that acceptance is required.***

 ***It should also be noted that a min. value must always be smaller than a max. value. If this condition is violated, the EK-87 automatically indicates the maximum, resp. minimum possible value. In this case the other value must first be increased or decreased appropriately:***

e.g.: old: $p_{\min} = 2.5 \text{ bar}$, $p_{\max} = 5 \text{ bar}$

new: $p_{\min} = 10 \text{ bar}$, $p_{\max} = 25 \text{ bar}$

Entering $p_{\min} = 10 \text{ bar}$ results in a flashing display:

$p_{\min} = 5 \text{ bar}$ (visible for 2 secs.) and $p_{\min} = 2.5 \text{ bar}$ (visible for 1 sec.).

After entering $p_{\max} = 25 \text{ bar}$, the value for p_{\min} can be changed to 10 bar.

8. If applicable, change the next value (procedure from Point 1). Once all values have been changed, they must still be accepted, i.e. released.
9. The acceptance is made in the system list (under the direct key "Z" and 1x "↑"). Values which have not yet been accepted can also be discarded (under direct key "Z" and 2x "↑"). One of the two is always required, otherwise after some time the warning "**E04 - Memory fault during comparison**" is given.

3 Description of functions

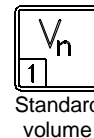

3.1 Standard volume list

AD	Designation/value	Value range	Units	Default	C/U	HLP	Ref.remark
Vn	Standard vol., undisturbed	12345678.123	m ³ / ft ³	-	C	H2	1,2,3,4,5
Vnd	Standard volume, disturbed	12345678.123	m ³ / ft ³	-	C	H4	1,2,3,4,6
Vnt	Standard vol., total amount	12345678.123	m ³ / ft ³	-	-	H6	1,2,3,4,7
VnP	Standard volume, adjustable	12345678.123	m ³ / ft ³	-	U	H24	1,2,3,4,8

AD = Abbreviated designation

C/U = Calibration/user lock

HLP = Identification in value number protocol

Remarks:

- Selection of the display factor (*1, *10 or *100) adjustable under "System - Display setting" subject to calibration regulations. Therefore, the following representations of the counter readings are possible:

Display factor *1 m ³	12345678	12345678,123
Display factor *10 m ³	12345678*10m ³	123456789,12
Display factor *100 m ³	12345678*100m ³	1234567890,1
- Display of the **post-decimal places** can be superimposed or faded out by pressing the "Enter" key during the display of the total volume (Vnt).
- Selection of the units (m³/ft³) can be set subject to calibration regulations under "System - Display setting" (future models).
- The entry of counter readings in dependence of the display factor is only possible in whole m³ or ft³.
- The time to the return to the standard display (Vn) can be set subject to calibration regulations under "System - Display setting".
- Counter reading under alarm conditions. Volume correction with appropriate substitute values.
- Sum of the undisturbed and disturbed counter readings
- Freely adjustable counter reading subject to user lock (Important: This is used in the DS-100 function under H2 in the V_n channel.)

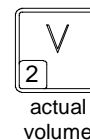

3.2 Actual volume list

AD	Designation/value	Value range	Units	Default	C/U	HLP	Ref.remark
V	Actual volume, undisturbed	12345678.123	m ³ / ft ³	-	C	H1	1,2,3,4
Vd	Actual volume, disturbed	12345678.123	m ³ / ft ³	-	C	H3	1,2,3,4,5
Vt	Actual vol., total amount	12345678.123	m ³ / ft ³	-	-	H5	1,2,3,4,6
VP	Actual volume, adjustable	12345678.123	m ³ / ft ³	-	U	H23	1,2,3,4,7

AD = Abbreviated designation

C/U = Calibration/user lock

HLP = Identification in value number protocol

Remarks:

- 1 Selection of the display factor (*1, *10 or *100) adjustable under "System - Display setting" subject to calibration regulations. Therefore, the following representations of the counter readings are possible:

Display factor *1 m³ 12345678 12345678,123

Display factor *10 m³ 12345678*10m³ 123456789,12

Display factor *100 m³ 12345678*100m³ 1234567890,1

- 2 Display of the **post-decimal places** can be superimposed or faded out by pressing the "Enter" key during the display of the total volume (Vt).
- 3 Selection of the units (m³/ft³) can be set subject to calibration regulations under "System - Display setting" (future models).
- 4 The entry of counter readings in dependence of the display factor is only possible in whole m³ or ft³.
- 5 Counter reading of actual volume counter under alarm conditions, correction occurs with appropriate substitute values.
- 6 Sum of the undisturbed and disturbed counter readings
- 7 Freely adjustable counter reading subject to user lock (e.g. adjustable to the value of the mech. meter).

3.3 Pressure sensor list

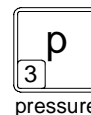

AD	Designation/value	Value range	Units	Default	C/U	HLP	Ref.remark
p	Absolute pressure, present	0.0...120.000	bar	-	-	L1	1
pTyp	Type of pressure sensor	2088	-	See DDS	C	P100	2
SN_P	Pressure sensor serial number	123456789012	-	See DDS	C	L16	-
prge	Pressure range and technique	0.0...120.000	bar	See DDS	C	L26	1,3,6
p_F	Pressure fixed value or substitute value	0.0...120.000	bar	See DDS	C/U	P2	1
pmin	Lower alarm limit, pressure	0.0...120.000	bar	See DDS	C	P24	1,4
pmax	Upper alarm limit, pressure	0.0...120.000	bar	See DDS	C	P23	1,4
pLLi	Lower warning limit, pressure	0.0...120.000	bar	See DDS	U	P102	1,5
pULi	Upper warning limit, pressure	0.0...120.000	bar	See DDS	U	P101	1,5
physt	Hysteresis pressure warning limits	0.5...99.9	%	0.5	U	P103	6
pILV	p, input lower value	3.880...4.120	mA	See DDS	C	P107	7
pIUv	p, input upper value	19.500...20.450	mA	See DDS	C	P108	7
pS1V	p sensor charact. 1st value	0...120 / 4...20	bar/mA	See DDS	C	P104	1,8
pS2V	p sensor charact. 2nd value	0...120 / 4...20	bar/mA	See DDS	C	P105	1,8
pS3V	p sensor charact. 3rd value	0...120 / 4...20	bar/mA	-	C	P106	1,8, 9
pn	Standard pressure	0.9000...1.0000	bar	1.01325	C	L156	1
pA	Air pressure (relative sensor)	0.90000...1.09999	bar	-	U	L158	1,10

AD = Abbreviated designation

C/U = Calibration/user lock

HLP = Identification in value number protocol

DDS = Design data sheet

Remarks:

- 1 Selection of the units (bar, psi, hPas, kPas) can be set under "System - Display setting" subject to calibration regulations.
- 2 The following settings are possible (selection after pressing the "Enter" key) using the cursor key "→" and "←":
3051, 2088, 1151 GP /AP, PTX-610 and S. type.
- 3 The absolute or relative method is possible (selection after pressing the "Input" key) via the cursor key "→" and "←".
- 4 Violation leads to alarm (Fault E31) and disturbance volume counting using the substitute value (p_F).
- 5 Violation leads to alarm (Fault E33 or E34) taking into account the hysteresis.
- 6 The hysteresis value refers to the upper value of the pressure range. It is only required for the warning limits. When the warning limit plus half the hysteresis

is exceeded (pULi), the warning is given and it is reset, when the warning limit minus half the hysteresis is undercut.

- 7 The linearisation values are dependent on the analogue input card and they are noted on the card (see design data sheet). The values must be re-entered when the card is replaced.
- 8 The linearisation values for the pressure sensor are set ex-works to the standard values of a pressure transducer. With recalibration on site they can be matched to the changed values of the pressure sensor. They must be completely entered, starting with the 1st value.
- 9 The third value must only be entered for a characteristic correction of the third order.
- 10 The air pressure value is only displayed for relative pressure sensors (see Remark 3).

3.3.1 Description of pressure input

The analogue input card, the inputs of which are connected to the pressure and temperature sensors, is designed as **intrinsically safe** (BVS 92.C.2046X; see also Appendix A). The card is approved as **associated electrical operating equipment for Ex Zone 1**. This means that sensors located in Ex Zone 1 can be connected to the EK-87.

 *The inputs are electrically isolated from the system, but not against one another. This means that only sensors of the same type can be used in Ex Zone 1. Mixed operation of intrinsically safe and flameproof sensors is not permitted in **Ex Zone 1**.*

The EK-87 is provided with a current output of 4.0 - 20.0 mA in two-wire technology for the connection of a pressure sensor. Both **absolute** and **relative pressure sensors** can be connected (specification of the air pressure on site is subject to the user lock).

The measured current is converted to the corresponding pressure value via a measured or entered characteristic and processed further. The correction of the sensor characteristic can be made with 2 or 3 reference points. With 2 reference points a linear characteristic is defined and with 3 reference points a quadratic line is used (better matching to the actual characteristic). The calibration procedure is described in more detail in the following chapter.

The **pressure range** characterises the limits of the pressure sensor's approval (= printed figures on name-plate), but it is only shown for display purposes.

The upper approval limit is however also required for the determination of the hysteresis for the warning limits (see below).

The pressure limits at which the alarm and disturbance volume counting is triggered are set by the **alarm limits** (without hysteresis). When the limits are violated, the programmed substitute value is used for the processing and counted in the disturbance volumes.

With the **warning limits** the procedure is different. When these limits are exceeded, a warning is given, but the incoming pulses continue to be counted normally (no disturbance volume counting). They are therefore only subject to the user lock. With the warning limits a **hysteresis** band must be considered. It refers to the upper approval value and is taken into account as follows, for example:

Approval: 14.0 - 70.0 bar; $P_{ULi} = 60$ bar; Hysteresis = 5%:

$Hyst_{(tot)} = 5\% \cdot 70 \text{ bar} = 3.5 \text{ bar}$; i.e. for each warning limit: $3.6 \text{ bar} : 2 = 1.75 \text{ bar}$

→ $P_{ULiswitch} = 60 \text{ bar} + 1.75 \text{ bar} = 61.75 \text{ bar}$

→ $P_{ULireset} = 60 \text{ bar} - 1.75 \text{ bar} = 58.25 \text{ bar}$

Therefore, when 61.75 bar is exceeded, the fault is displayed (here: E34 - Upper warning limit, pressure) and when the pressure falls below 58.25 bar the fault is then reset again.

3.3.2 Adjustment of the pressure input

The input card in the EK-87 (board **EXAE2**) does not have any setting controls for adjustment, so that the characteristic correction of the A/D converter is carried out via software. The adjustment is of course subject to the adjustment lock. The procedure for the characteristic correction takes place in two stages, both for the pressure input and for the temperature input and it is explained in more detail in the following.

The correction of the pressure sensor input normally takes place in two steps:

- 1.) Adjustment of the input card (current-current correction)
- 2.) Adjustment of the sensor characteristic (current-pressure correction)

Therefore, both the analogue input and the sensor can be set separately and very precisely.

The first correction stage relates to the transfer function of the A/D converter. The characteristic of an A/D converter channel can be described, substantially simplified, as a function of the 2nd order. With suitable conversion one would like to obtain a corrected display value which corresponds to the quantity applied at the input. For the implementation of this correction it is necessary to find the two transfer coefficients. This takes place in an adjustment procedure which is carried out with two accurately

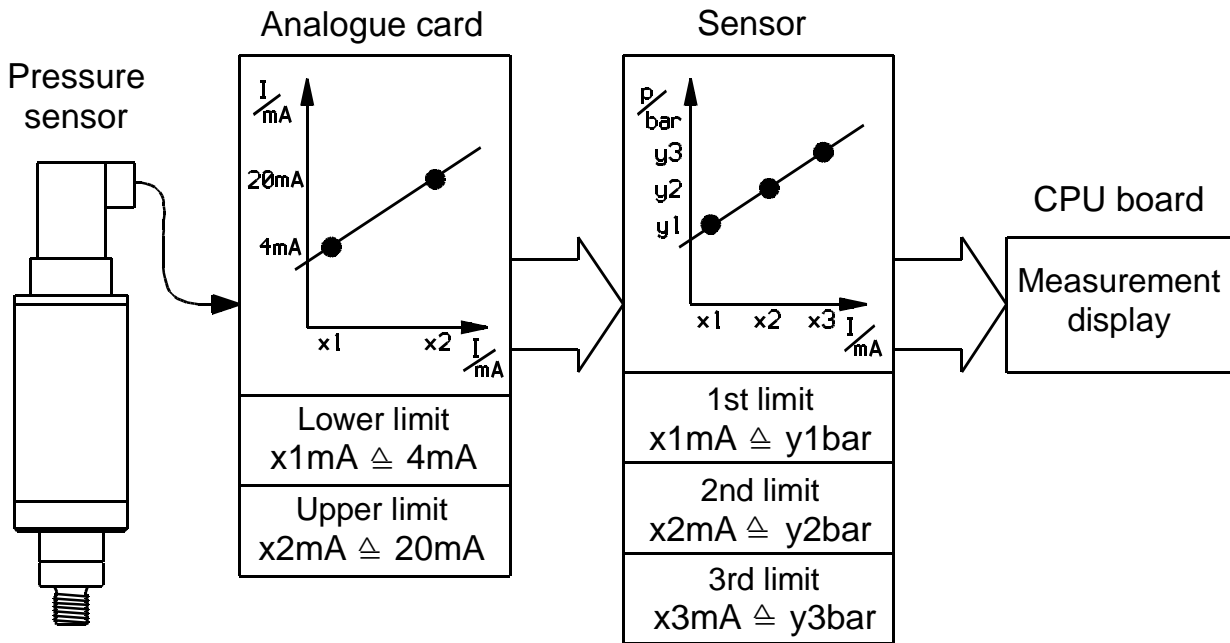

Figure: Correction of the pressure sensor characteristic.

known input quantities that are applied. The known quantities for the pressure input are **X1 = 4.000 mA** and **X2 = 20.000 mA**. The correction quantities are found in the manufacturer's test laboratory for each card and are retained on the board and on the design data sheet enclosed with each EK-87 supplied. The appropriate correction reference points have been set ex-works so that the user does not need to carry out the adjustment procedure himself.

If an analogue card is replaced on site, then the input of new parameters is unavoidable.

In order to find the characteristics of the analogue card, the point: "**Binary value, pressure input**" is called in the "**Measurement list**". The displayed value characterises the measurement quantity "before" the characteristic correction. Now exactly 4.000 mA must be set on the pressure input. The reference value is displayed as feed back. The important feature is that the displayed value must be located in the permissible range (3880...4120). The value must be divided by 1000 (since display of the binary value occurs in mA) and noted on the card and in the design data sheet. A similar procedure is used for the upper measurement limit (20 μ A) and the range (19500...20450).

Then the reference points found are entered in the "pressure list" under:

- p input lower val. (P107) for the 4 mA value and
- p input upper val. (P108) for the 20 mA value.

Attention must be paid to the release of the settings (see Chap. 2.3.4).

3.3.3 Pressure sensor adjustment

Apart from the first correction stage described above, a second correction stage is provided, enabling non-linearities from the ideal pressure sensor characteristic to be compensated. In this manner the highest possible accuracy is guaranteed for the complete measurement system.

Without sensor adjustment the EK-87 represents the set pressure range (e.g. 2 to 10 bar) over a current range from 4 to 20 mA, i.e. a linear characteristic is assumed.

In reality a sensor only supplies this characteristic in the ideal case. Therefore, a characteristic correction can also be entered via three pairs of values for pressure and current. If two pairs of values are entered, the computation takes place according to a straight-line equation and with the input of three pairs of values a quadratic function (parabola) is taken into account.

During the initial operation at Elster the reference values are set permanently to the values specified in the pressure range, since the connected pressure sensor is calibrated and therefore has the correct values. The measurement and entry of the "actual" values is only of interest during recalibration where the pressure sensor itself cannot be recalibrated.

The procedure is somewhat similar to the pressure input adjustment, but here however the measured analogue values are found and entered (under "**Measurements - Analogue values, pressure**" (L247)) for the relevant required pressure after the adjustment.

The following values give an example:

Pressure range 2 - 10 bar; 3 reference points required:

➔ Default setting: 2.000 bar ≙ 4.000 mA
 6.000 bar ≙ 12.000 mA
 10.000 bar ≙ 20.000 mA

With the recalibration the associated current values may change and must then be re-entered. (e.g. 4.005 mA for the value 2.000 bar, etc.).

 *It is essential that the entry of the reference points starts at the 1st value, even if it has not changed. If necessary, the values must be entered again. If the third reference point is not used, then it should be set to 0.000 bar and 0.000 mA.*

Attention must be paid to the release of the settings (see Chap. 2.3.4).



Temperature

3.4 Temperature sensor list

AD	Designation/value	Value range	Units	Default	C/U	HLP	Ref.remark
T	Temperature, present	-13.0...+63.00	°C	-	-	L2	1
Ttyp	Type of temperature sensor	EBL160AF/EXI	-	See DDS	E	P150	2
SN_T	Temp. sensor serial number	123456789012	-	See DDS	E	L17	
Trge	Temperature range	-13.00...+63.00	°C	See DDS	E	L27	1,5
T_F	Temperature fixed value / substitute value	-13.00...+63.00	°C	See DDS	B	P3	1
Tmin	Lower alarm limit, temperature	-13.00...+63.00	°C	See DDS	E	P22	1,3
Tmax	Upper alarm limit, temperature	-13.00...+63.00	°C	See DDS	E	P21	1,3
TLLi	Lower warning limit, temp.	-13.00...+63.00	°C	See DDS	B	P152	1,4
TULi	Upper warning limit, temp.	-13.00...+63.00	°C	See DDS	B	P151	1,4
Thyst	Hysteresis temp. warning limits	0.5...99.9	%	0.5	B	P153	5
TILV	T, input lower value	23.80...25.80	Ohm	See DDS	E	P157	6
TIUV	T, input upper value	122.000...126.000	Ohm	See DDS	E	P158	6
TS1V	T sensor charact. 1st value	-10...60 / 90...125	°C/Ohm	See DDS	E	P154	1,7
TS2V	T sensor charact. 2nd value	-10...60 / 90...125	°C/Ohm	See DDS	E	P155	1,7
TS3V	T sensor charact. 3rd value	-10...60 / 90...125	°C/Ohm	See DDS	E	P156	1,7,8
Tn	Standard temperature	270.00...299.00	°C	273.15	E	L157	1

AD = Abbreviated designation

C/U = Calibration/user lock

HLP = Identification in value number protocol

DDS = Design data sheet

Remarks:

- Selection of the units (°C, K, °F) can be set under "System - Display setting" subject to calibration regulations.
- The following settings are possible (selection after pressing the "Enter" key via the "Cursor right" key):

EBL160AF/EXD	EBL160AF/EXI	EBL160AD/EXD
EBL250AF/EXD	EBL250AF/EXI	EBL250AD/EXI
EBL140AD/EXI	EBL50AF/EXI	S. type

Explanation:

EBLxxx = Installed length; A = Connection head; F = Used in sensor pocket; D = Used directly in the gas; EXD = Flameproof; EXI = Intrinsically safe.

- Violation leads to an alarm (Fault E41) and disturbance volume counting using the substitute value (T_F).
- Violation leads to a warning (Fault E44 or E45) taking into account the hysteresis.

- 5 The hysteresis value relates to the upper value of the set temperature range. It is only needed for the warning limits. When the warning limit (TULi) plus half the hysteresis is exceeded, the warning is produced and is reset again when the warning limit minus half the hysteresis is undercut.
- 6 The linearisation values for the temperature input are dependent on the analogue input card and are noted on the card (see Design Data Sheet). They must be re-entered appropriately when the card is replaced.
- 7 The linearisation values for the temperature sensor are set ex-works to the standard values for a Pt100. During recalibration on site they can be matched to the changed values of the temperature sensor. They must be fully entered starting with the 1st value.
- 8 The third value only needs to be entered with a characteristic correction of the 2nd order.

3.4.1 Description of temperature input

The temperature sensor input is located on the same card as the pressure sensor input. It is also designed to be **intrinsically safe** (BVS 92.C.2046X; see also Appendix A). Therefore, please take note of the information in Chapter 3.3.1.

The EK-87 input is designed for the connection of a temperature sensor in four-wire technology. Using this method the resistance of the temperature sensor can be measured very accurately and the length of the leads has practically no effect on the measurement accuracy. Temperature sensors conforming to DIN IEC 751 are used with an accuracy of 1/3 DIN Class B ($= 0.1 \text{ K} + 0.005 \cdot t \text{ [}^\circ\text{C]}$).

The measured resistance is converted via a measured or entered characteristic to the corresponding temperature value and processed. The correction of the sensor characteristic can take place using 2 or 3 reference points. With 2 reference points a linear characteristic and with 3 reference points a quadratic characteristic is defined. The latter provides better matching to a real characteristic.

The description of the parameters in the temperature sensor list corresponds to that for the pressure sensor (see Chap. 3.3.1).

3.4.2 Temperature input adjustment

To a large extent, the correction of the temperature input corresponds to the description for the pressure sensor input (see Chap. 3.3.2). The difference is that the temperature characteristic needs resistances instead of currents. It is also carried out in two stages:

- 1.) Input card characteristic
- 2.) Temperature sensor characteristic

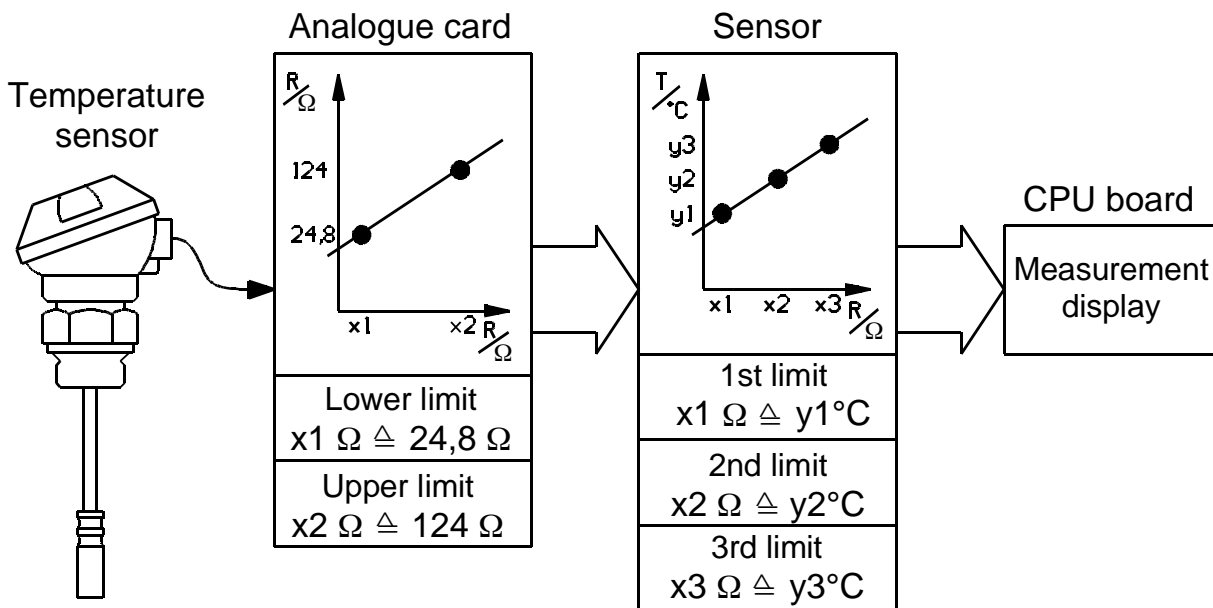

Figure: Correction of the temperature sensor characteristic.

The two reference values for the temperature input are **X1=24.8 ohm** and **X2=124.00 ohm**. Therefore the relevant exact adjustment resistances must be connected instead of the currents. In order to define the characteristic of the analogue card, the point: “**Binary value, temperature input**” is called in the “**Measurement list**”. The displayed value again identifies the measurement quantity “before” the characteristic correction. Now exactly 24.8 ohm must be connected to the temperature input. The resistance must be connected between I+/U+ and I-/U- (connect I+ to U+ and I- to U-). It is important that the displayed value is located in the permissible range (2380...2580). The value must be divided by 100 and noted on the card and on the design data sheet. Similarly, the upper measurement limit (124 ohm) and the range (12200...12600) must be defined. Then the defined reference points are entered in the “Temperature list” under:

- T input Lower val. (P157) for the 24.8 R value and
- T input Upper val. (P158) for the 124 R value.

Attention must be paid to the release of the settings (see Chap. 2.3.4).

3.4.3 Temperature sensor adjustment

The procedure for the temperature sensor adjustment is also similar to that for the pressure sensor (see Chap. 3.3.3).

Here the measured analogue values are determined after adjustment (under “**Measurements - Analogue value, temperature**” (L248)) for the relevant desired temperature and entered in the temperature list under the values: “**Temperature - T sensor characteristic 1 - 3V**” (P154-156).

During recalibration the associated resistance values may also change, requiring re-entry (e.g. 96.10 ohm for the value -10.00°C etc.).

 *It is essential that the entry of the reference points takes place from the 1st value even if it has not changed. If necessary, the values must be entered again. If the third reference point is not used, then it must be set to 0.00°C and 0.00 ohm.*

Attention must be paid to the release of the settings (see Chap. 2.3.4).

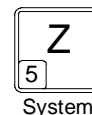

3.5 System list

AD	Designation/value	Value range	Units	Default	C/U	HLP	Ref.remark
Z	Correction factor, present	0...130.00000	1	-	-	L3	
Date	System date	12.12.12	-	-	C	L7	
Time	System time	12:12:12	-	-	C	L8	1,2
hum	Operating hours counter	123456	h	-	-	L9	
BATT	Residual back-up battery capacity	123456	h	45'000	C	L35	3
VERS	Software version + checksum	V1.12 / \$1234	- / hex	See DDS	-	L34	4
SN_V	Ser. no., vol. corrector	12345678	-	See DDS	C	L18	
DCF-S	DCF-77 Radio Clock status	Text display	-	-	-	-	5
DCF-Z	DCF-77 Radio Clock summer time	yes/no	-	no	U	P79	6
DSfG setting - main menu		see Chap. 3.5.1					
IDOM setting - main menu		see Chap. 3.5.2					
p-Mod	Pressure mode	Measurement/ fixed value		Measure- ment	C	P12	7
T-Mod	Temperature mode	Measurement/ fixed value		Measure- ment	C	P13	7
Display setting - main menu		see Chap. 3.5.3					
Co-Clr	Reset all counter readings	-	-	-	C	P48	
Cal-St	Display calibration lock status	open/ close	-	-	-	P90	
User lock - main menu		see Chap. 3.5.4					
PA-AD	Parameter accept / discard		-	-	-	P99	8

AD = Abbreviated designation

C/U = Calibration/user lock

HLP = Identification in value number protocol

DDS = Design data sheet

Remarks:

- 1 With the calibration switch closed the time can only be set by ± 20 sec.
- 2 With the DCF-77 Radio Clock connected and for correct operation the message "CET" (winter time - preferred standard) or "CEST" (summer time) is displayed.
- 3 Guaranteed period for which the EK-87 can safely save data using the back-up battery.
- 4 Software version number and automatically determined checksum of the program memory (EPROM).
- 5 With connected DCF-77 Radio Clock the momentary status of reception is displayed (see Chap. 3.5.5 for explanation of radio clock).
- 7 Essential to maintain as "no", otherwise the correct allocation of the consumption data in the DS-100 function is not possible.
- 7 Correction with fixed or measured values for p and T.
- 8 For "accepting / discarding" parameters, see Chap. 3.5.5.

3.5.1 DSfG sub-list

AD	Designation/value	Value range	Units	Default	C/U	HLP	Ref.remark
Stat	DSfG interface status	Text display	-	-	-	-	1
Addr	EK-87 address on DSfG bus	A-Z, Ä, Ü, Ö, ^, _	-	U	C	P600	1
Bd	Baud rate on DSfG bus	9600 / 19200	Bd	9600	C	P601	1
TS	Bus time TS	100000...400000	Bit times	240000	C	P602	1
A-cyc	Archiving cycle (interval size)	1, 2, 3, 4, 5, 6, 10, 15, 20, 30 und 60	min	60	C	P603	1
GeTim	General polling time	1...60	min	6	C	P604	1,2
Trig.gen	Trigger general polling	-	-	-	-	P605	1,2
User	List of bus participants	1-31	Particip.	-	-	L405	1
CRC	Start value for CRC checksum	0...65535	-	0	C	P606	1,3
Tel-I	Interval end telegram	yes / no	-	yes	C	P610	
Tel-L	Alarm telegram	yes / no	-	yes	C	P611	
Tel-W	Warning telegram	yes / no	-	no	C	P612	
Tel-H	Information telegram	yes / no	-	no	C	P613	
Tel-P	Telegram for changed param.	yes / no	-	yes	C	P614	
A/M	Interrog. tel. for indiv. data elements	0...999	-	-	-	-	
A/V	Interr. tel. for DE ranges	0...999	-	-	-	-	
A/O	Interr. tel. DE about allocation no.	0...999	-	-	-	-	
A/Z	Interr. tel. DE about time ranges	0...999	-	-	-	-	
E/M	No. of sett. tel. about indiv. DE	0...999	-	-	-	-	
D/T	No. of data trans. via text strings	0...999	-	-	-	-	
Z	No. of rec. time-synch. telegr.	0...999	-	-	-	-	
F	No. of rec. freeze requests	0...999	-	-	-	-	
T-I	No. of dep. I telegr.	0...999	-	-	-	-	
T-L	No. of dep. L telegr.	0...999	-	-	-	-	
T-W	No. of dep. W telegr.	0...999	-	-	-	-	
T-H	No. of dep. H telegr.	0...999	-	-	-	-	
T-P	No. of dep. P telegr.	0...999	-	-	-	-	

AD = Abbreviated designation

C/U = Calibration/user lock

HLP = Identification in value number protocol

DDS = Design data sheet

Remarks:

- 1 See Chapter 3.5.1.2 for a description of the values.
- 2 Only when the EK-87 is set as bus master (address:"_")
- 3 CRC start value "0" = No signature during data transmission

3.5.1.1 The DSfG interface

The EK-87 supports as an option the DSfG (*Digital Interface for Gas Measurement Devices*). This interface is based on the DVGW Working Sheet **G485** and is used for interrogating measurements (e.g. pressure and temperature) and counter readings (e.g. V_n , V , etc.) for processing, for example in DSfG-compatible recording equipment.

The following explanations of the DSfG interface in the EK-87 are not claimed to be complete and further details should be taken from the official DSfG documents.

The DSfG is based on the 1-to-1 connection (the *DSfG bus*) of all connected device interfaces. Each DSfG bus must be precisely planned for in setting up in order to ensure trouble-free operation. This is provided by mainly two parameters (subject to the **calibration lock**):

- the **bus address**

Each DSfG device must be able to be identified by an unambiguous bus address. Up to 31 different bus addresses, i.e. DSfG bus devices, can be present on a DSfG bus; valid bus addresses are all capital letters (A...Z) and a few special characters including the “_” character. The device with this address implements the bus management, i.e. the control, of which device at which time can send its data (-> **bus master**). It must be present on each DSfG bus. The EK-87 can also be employed as the bus master.

- the **transmission speed**

All devices on the DSfG know how quickly data is to be sent and received. This transmission speed or *baud rate* is measured in bits per second and is adjustable in two steps: 9600 Bd and 19200 Bd.

- the **start value for CRC checksum formation**

An appropriately secure transmission method is required for the transfer of messages subject to official calibration regulations between the EK-87 and other DSfG bus participants (e.g. recording equipment). This is achieved with a so-called CRC-12 procedure. It is then certain that the occurrence of two errors is detected. In order to be able to evaluate this type of message, the same start value must be entered for both participants.

A feature of the DSfG is the event orientated recording of billing data. A regularly occurring event is the end of the set recording interval (end of interval); further events are faults that occur which can be classified in the volume corrector in the types *alarm*, *warning* and *information*. With each event that occurs the EK-87 notes its momentary meter readings for V and V_n , the averages of corrector pressure and temperature and the alarm status. In addition it informs the other devices about the new data by sending an *attention telegram*. This attention telegram causes the recording unit(s) connected

to the DSfG bus to fetch the new data. The transmission of attention telegrams by the EK-87 can be set during set-up subject to the **calibration lock**.

The “time synchronisation” and the command “freeze values” are included in the executable commands. These are sent via the bus master to the EK-87. Also, a modification of the gas analysis values can be carried out over the DSfG bus. A change is saved with a time stamp in the list “**Gas analysis - Log book**”.

3.5.1.2 Description of the values in the DSfG sub-list

In the “**DSfG setting**” sub-list (under the list “**System**”) the required settings can be made for the “*Digital Interface for Gas Measurement Devices*” (DSfG).

The momentary status of the EK-87 and its interface card in relation to the connected DSfG bus is displayed under the point “**Status**”:

Display	Meaning
Reset	Basic status after setting up or when changing DSfG parameters.
No card found	The initialisation of the DSfG card has not been successful. The card is not present or is defective.
Initialisation	The initialisation of the DSfG interface card is currently running.
Awaiting G poll	The DSfG card initialisation is complete. It is waiting for <i>general polling</i> by the bus master which includes it in the bus traffic.
On bus!	The EK-87 participates in the bus traffic or the address “_” (bus master) is set.

The possible settings on the DSfG interface are:

Setting	Meaning	Value range
Bus address	Device address under which the EK-87 responds on the DSfG bus.	A-Z Ä Ö Ü ^ _
Baud rate	Data transmission speed on the DSfG bus.	9600, 19200
Bus time TS	G485 transport monitoring time.	240000/480000
Archiving cycle	Time in minutes after which an interval end occurs.	1, 2, 3, 4, 5, 6, 10, 15, 20, 30, 60
Gen. poll. time	Time for all bus participants to respond (general polling)	1...60 min. *1
Trigger gen. poll	Manually trigger general polling	- *1
Bus participant	Display addresses of all connected bus participants	A-Z Ä Ö Ü ^ _ *1
CRC start value	Start value for secure transfer ("0" = No CRC-12 check)	0...65535
I telegrams	Production of an attention telegram Type I after each interval end.	Yes/no
L telegrams	Production of an attention telegram Type L with each alarm.	Yes/no
W telegrams	Production of an attention telegram Type W for each warning.	Yes/no
H telegrams	Production of an attention telegram Type H for any information.	Yes/no
P telegrams	Production of an attention telegram Type P for each change of parameters	Yes/no

Then follow the displays of the received and transmitted telegrams. All telegram counters are three-figure decimal numbers and are incremented by one for each detected telegram. They reset to 0 on reaching 999 as with a three-digit mechanical counter.

The abbreviations mean:

Abbreviation	Meaning
A/M	Interrogation telegrams for single data elements
A/V	Interrogation telegrams for data element blocks
A/O	Interrogation telegrams for data element blocks regarding allocation number
A/Z	Interrogation telegrams for data element blocks regarding time ranges
E/M	Setting telegrams for single data elements
D/T	Data transmissions using text strings
NUAs	Number of unscheduled responses from EK-87
Z	Received attention telegrams Type Z (time synchronisation)
F	Received attention telegrams Type F (freeze request)
I	Sent attention telegrams of Type I (interval end)
L	Sent attention telegrams of Type L (alarm)
W	Sent attention telegrams of Type W (warning)
H	Sent attention telegrams of Type H (information)
P	Sent attention telegrams of Type P (changed parameter)

3.5.1.3 Setting up the DSfG interface

To operate the DSfG card the jumpers on the card must first be set according to the on-site requirements (see Chap. 4.5.2 and “*Technical Specification for DSfG realisation*”). Then, the EK-87 address on the bus and the required baud rate must be programmed (see previous chapter). The setting of the interval time (archiving cycle) or the release of “*attention*” telegrams can then be carried out. Once this is done, the card is ready for operation.

A correct card configuration is indicated in the menu “**DSfG status**” after some time with the message “*On bus!*”, showing that the DSfG card is ready for operation.

3.5.1.4 DSfG data element list

The following data elements can be called by the EK-87 via the DSfG interface (see DVGW Working Sheet G485 for further details):

Command	Meaning	Command	Meaning
aaa	Own entity type	bba	Standard flow
aac	SW version of DSfG SW	bbc	Actual flow
aba	Manufacturer	bcaaa	Mode, volume inputs
abb	Device type	bcaab	cp A1S
abc	Serial number	bcaac	cp A1R
abe	SW version entity	bcaba	Upper warning limit Q
abf	Last parameterisation	bcabb	Lower warning limit Q
aca	Date / time	bcabc	Upper alarm limit Q
acb	Time zone	bcabf	Permiss. dev. A1S/A1R in %
acc	Last time-zone adjustment	bcabh	Permiss. time, meter run-up
ace	Last calibration	bcabi	Permiss. time, meter run-down
add	Access Code 1	bcdaa	Mode, absolute pressure
ade	Access Code 2	bcdba	Substitute value
adf	Calibration switch	bcdbb	Lower warning limit
aea	Last event	bcdbc	Upper warning limit
aeb	Date of last event	bcdbd	Lower alarm limit
afa	Pressure unit	bcdbe	Upper alarm limit
afb	Temperature unit	bceaa	Mode, gauge pressure
afc	Flow unit	bceba	Substitute value
aff	Calorific value unit	bcebb	Lower warning limit
baaa	Standard volume	bcebb	Upper warning limit
baab	Residual volume Vn	bcebd	Lower alarm limit
baae	Actual volume	bcebe	Upper alarm limit
baaf	Residual volume V	bcfaa	Mode, temperature
baca	Disturbance volume Vn	bcfba	Substitute value
bacb	Disturbance residual vol. Vn	bcfbb	Lower warning limit
bace	Disturbance volume V	bcfbc	Upper warning limit
bacf	Disturbance residual vol. V	bcfbd	Lower alarm limit
baga	Froz. 1: Standard volume	bcfbe	Upper alarm limit
bagb	Froz. 1: Residual vol. Vn		
bage	Froz. 1: Actual volume		
bagf	Froz. 1: Residual volume V		

Command	Meaning
bdaa	Frequency, Vol. Input 1
bdab	Frequency, Vol. Input 2
bdda	Pressure, abs. meas. quantity
bddd	Pressure, abs. average
bdde	Pressure, abs. momentary value
bdea	Pressure, rel. meas. quantity
bded	Pressure, rel. average
bdee	Pressure, rel. momentary value
bdfa	Temp., meas. quantity
bdfd	Temp., average
bdfc	Temp., momentary value
beaaa	Mode, correction method
beaab	Standard pressure
beaac	Standard temperature
beaad	k fixed value
beba	Calorific value
bebb	Standard density
becb	Density ratio
bebd	CO2
bebe	N2
bebf	H2

Command	Meaning
bfa	Z value
bfd	K value
bhaa	Length of meas. period
bhac	Operating time
bhfa	Last event
bhfb	Date of last event
bhfc	Corrector status
bia	Standard Interrogation 1
bib	Standard Interrogation 2
biba	Standard Interrogation 2 from allocation number
bibb	Standard Interrogation 2 to allocation number
bie	Standard Interrogation 5
biea	Standard Interrogation 5 from allocation number
bieb	Standard Interrogation 5 to allocation number
bif	Standard Interrogation 6
bifa	Standard Interrogation 6 from allocation number
bifb	Standard Interrogation 6 to allocation number

3.5.2 IDOM protocol sub-list

AD	Designation / value	Value range	Units	Default	C/U	HLP	Ref.remark
ID-imm	IDOM protocol immediately	-	-	-	-	P56	1,2
ID-min	IDOM protocol every xx mins.	0...60	min	0	-	P57	2
ID-time	IDOM protocol at xx hrs.	0...24	hrs.	0	-	P58	3

AD = Abbreviated designation

C/U = Calibration/user lock

HLP = Identification in value number protocol

DDS = Design data sheet

A more precise description of the IDOM protocol is given in Chapter 3.15.

3.5.3 Display setting sub-list

AD	Designation/value	Value range	Units	Default	C/U	HLP	Ref.remark
BgIII	Background illumination	on/off/ auto.		autom. off	U	P95	1,2
tRet	Time to return to V _n	0...999	min	3	C	P91	2
DFV	Display factor for V	*1 / *10 / *100	-	*1	C	L101	3
DFV _n	Display factor for V _n	*1 / *10 / *100	-	*1	C	L102	3
V _n /b+	Display post-dec. pl. V/V _n	yes/no	-	no	-	P94	4
Lang	Language used	German/English	-	English	U	P70	5
U-Vol	Unit for volume measurement	m ³ / ft ³	-	m ³	C	P71	6
U-p	Unit for pressure display	bar / psi / h + kPas	-	bar	C	P72	6
U-T	Unit for temperature display	°C / K / °F	-	°C	C	P73	6
Contr	Contrast setting LCD display	-	-	-	-	-	7

AD = Abbreviated designation

C/U = Calibration/user lock

HLP = Identification in value number protocol

DDS = Design data sheet

Remarks:

- 1 Since the background illumination has a "service life" of about 50,000 hrs, the mode "always on" should not be used. Otherwise the intensity will fade with time. With the mode "autom. off" the background illumination switches on immediately when a key is pressed.
- 2 The background illumination is also switched off with the set time for returning to the standard display (V_n).
- 3 The following representation of the counter readings are possible:

Display factor *1 m ³	12345678	12345678,123
Display factor *10 m ³	12345678*10m ³	123456789,12
Display factor *100 m ³	12345678*100m ³	1234567890,1
- 4 Display of the post-decimal places for the counter readings.

- 5 Changeover between 2 languages (standard: German/English).
- 6 In future the units for volumes, pressure and temperature will be able to be adapted to the requirements specific to the country.
- 7 Setting of the LCD contrast (with user guidance) and automatic control depending on the device temperature.

3.5.4 User lock sub-list

AD	Designation/value	Value range	Units	Default	C/U	HLP	Ref.remark
U-St	User lock status	open / closed	-	open	-	-	1
SuL	Supplier combination, open / close	6-figure /-	-	000000	U	P0	2
SuL-ch	Change supplier combination	6-fig.+ check	-	-	U	P9	3
CuL	Customer combination, open/close	6-figure /-	-	000000	U	P10	2
CuL-ch	Change customer combination	6-fig.+ check	-	-	U	P11	3

AD = Abbreviated designation

C/U = Calibration/user lock

HLP = Identification in value number protocol

DDS = Design data sheet

Remarks:

- 1 Displays the present status of the user lock. The ex-works setting is with both locks open, i.e. all locks have "000000" as default combination.
- 2 The functions "close" and "open" are displayed to the user depending on the status of the relevant lock.
- 3 The function "change" is only displayed with an open lock.

3.5.4.1 The user lock

The user lock is used for securing all data which is not relevant for calibration regulations, but which is not to be changed without proper authorisation. The **user lock** consists of a **supplier's combination** and a **customer's combination**, each of which must be entered as a 6-figure number. Both combinations are completely independent of one another. This subdivision enables a mutual control between the gas utility and the consumer. The **supplier** and **customer combinations** can both be changed when the **user lock** or the **calibration lock** is open. The calibration lock however has the higher priority. Therefore, with the calibration lock open, the parameters which are subject to the user lock can also be changed.



If the calibration lock is closed, the user lock is automatically closed if the combinations have been allocated.

As supplied ex-works, the user lock is open and both combinations are set to "000000". This default setting means that the relevant lock has no function.

Allocation of the user combination

First during set-up, the default setting ("000000" \equiv *Combinations not allocated*) must be changed for the required lock. To do this, the point "**Change supplier combination**" or "**Change customer combination**" is called in the sub-list "User lock".

The desired combinations can be entered after pressing the "Enter" key. It is **essential** to enter a 6-figure number. Only "?" is displayed as acknowledgement. After confirmation with the "Enter" key, the combination must be entered again as a check. A change is only accepted and appropriately displayed with the entry of two identical combinations.

 *It is important to note the combination number in your own documentation, since the user lock will not be able to be opened if the combination is lost. The only way out is then to open the calibration lock with corresponding costs for the calibration official!*

Locking the user lock

A lock can only be closed if both combinations have been correctly entered. A prerequisite is that the calibration lock is closed. If this is not the case, it is noted in the display and the lock closed when the calibration lock is closed. Otherwise the lock is closed immediately and only the option "open" is presented in the display.

Opening the user lock

If the user and the calibration locks are closed, only "open" options are presented in the sub-list.

To open the user lock the previously allocated combinations must be entered. Only "?" is displayed as acknowledgement. If the combination is correct, the corresponding lock is labelled as "open" and the options "close" and "change" presented. Otherwise the lock remains closed, only the option "open" is presented and the relevant combination must be entered again.

 *If both combinations have been allocated (\neq "000000"), then both combinations must also be entered to open the user lock.*

3.5.5 Accepting parameters

AD	Designation/value	Value range	Units	Default	C/U	HLP	Ref.remark
PA-AD	Discard params. not accepted	-	-	-	-	-	
PA-AD	Accept all changed params.	-	-	-	-	P99	

AD = Abbreviated designation

C/U = Calibration/user lock

HLP = Identification in value number protocol

DDS = Design data sheet

In this sub-list of the “**System**” changed parameters must either be accepted or discarded. The purpose of accepting them together is so that where a number of parameters are changed, they are all accepted and become valid at the same point in time.

 *The possibility of “accepting” or “discarding” parameters is only offered if parameters have been changed. With each changed parameter the new value is written for 2s in the display and the old value for 1s. This shows that the EK-87 is still operating with the old value and that the new value will be used after the next acceptance is made.*

 *The function can be simply obtained by pressing “↑” once after pressing the “Z” key.*

 *Acceptance is required for almost all parameters and should therefore should always be carried out. If it is forgotten, the fault E04 - “Memory fault during comparison” appears after some time. Acceptance is also independent of the state of the calibration and user locks. However, changes to the parameters are only possible with the lock open.*

Discard parameters

If the “↑” key is pressed twice after pressing the “Z” key and when parameters have been changed, the point “Discard parameters” is obtained. The original status can be established again by selecting “discard”. Only the parameters that have not been accepted can be reset.

 *Parameters released by “accept” cannot be reverted using “discard”.*

3.5.6 DCF-77 Radio Clock

The EK-87 can receive and evaluate the signals from a DCF-77 Radio Clock. This means that it has access to one of the most accurate atomic clocks in the world. It is operated by the PTB in Braunschweig. The maximum deviation of the clock is less than one second in 300,000 years.

The time signal is transmitted via the DCF-77 transmitter at Mainflingen near Frankfurt. The time and the date are transmitted 1x per minute in a defined telegram. This is registered by the receiver module (**Expert mouse CLOCK**) and transferred via the serial interface to the EK-87.

With operation of the DCF-77 Radio Clock, the time in the EK-87 is kept automatically and independent of the status of the calibration lock. This signal can be transferred to following equipment using the switching outputs.

The corresponding status is also shown in brackets next to the PTB time in the display of the system time (M = CET; S = CEST).

Under "**Summer time: Yes/no**" it is possible to enable the clock to change automatically at the changeover summer/winter time. This function is only possible if the DCF-77 Radio Clock receiver has been installed.

 *This function should however not be used since the integrated DS-100 function (high-flow recording device), and following equipment storing the data would experience problems. For example, too many interval values would be recorded (CEST -> CET) or interval values would be missing (CET -> CEST).*

The status of the radio clock is displayed under "**DCF-77 status**" in the list "System". The following possibilities are displayed:

Display text	Meaning
No reception!	No DCF-77 Radio Clock receiver present or badly installed (see Chap. 4.5.3).
Reception level OK	Receiver positioned correctly; searching for minutes gap in DCF-77 telegram.
Synchronisation	Evaluation of the telegrams; after 2 minute-telegrams have been fully and error-free evaluated, the PTB time is displayed.

Setting up the DCF-77 Radio Clock

First of all the jumpers for the operation of the EK-87/S must be set (see Chap. 4.5.3) in order to operate the DCF-77 Radio Clock.

☞ *Since the reception of the Expert-mouse CLOCK is very dependent on the installation conditions, it is essential to follow the installation instructions (Chap. 4.5.3).*

After switching on, the LED on the Expert mouse CLOCK must indicate green and flash red in one-second cycles. The text “**Reception level OK**”, then “**Synchronisation**” and then the valid PTB time should appear in the “System “ list in the display “DCF-77 status”. The desired mode can be set via “**Summer time: Yes/no**” (see remarks in the previous chapter). The DCF-77 Radio Clock is then ready for operation.

3.6 Gas analysis list

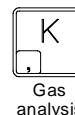

AD	Designation/value	Value range	Units	Default	C/U	HLP	Ref.remark
K	Present K value	0.5...1.50000	-	-	-	L6	
KMod	Mode, K value computation	GERG-88 V33	-	GERG-88	C	P8	1
K_F	K-value fixed /substitute value	0.5...1.50000	-	1.00000	C/U	P1	2
Hon	Calorific value	6.000...13.000	kWh/m ³	10.3000	U	L145	3
RHon	Standard density	0.7100...1.1600	kg/m ³	0.8301	U	L146	4
dv	Density ratio	0.554...0.75	-	-	U	L168	5
xCO2	Molar content of carbon dioxide	0.00...30.00	%	1.29	U	L148	6
xH2	Molar content of hydrogen	0.00...10.00	%	0.00	U	L147	4,6
xN2	Molar content of nitrogen	0.00...15.00	%	-	U	L178	5,6
Log book, gas analysis		see Chapter 3.6.1					

AD = Abbreviated designation

C/U = Calibration/user lock

HLP = Identification in value number protocol

DDS = Design data sheet

Remarks:

- The computation of the K value can be carried out using the following methods:
 - **Standard GERG-88 V33**
 - **AGA-NX-19-mod-BR.KORR.3H**
 - **K=constant** ($0.5 \leq K \leq 1.50000$)

With a change of the K value mode, the permissible limits of the computation method and the gas analysis values must be checked.

- 2 The fixed/substitute value is only displayed with the K-value mode: "Fixed value" (under "C") or with the mode: "AGA-NX-19" (under "U") as substitute value.
- 3 Calorific value referred to standard temperature (fixed at 273.15 K) and standard pressure (fixed at 1.01325 bar).
- 4 Only with the K-value mode: GERG-88 (Remark: see below).
- 5 Only with K-value mode: AGA-NX-19 (Remark: see below).
- 6 Entry as molar content; expressed in percent.

Range limits for GERG-88:

Calorific value	$H_{o,n}$	(Hon)	$6.0 \leq H_{o,n} \leq 13.0$	kWh/m ³
Standard density	Rho_n	(RHon)	$0.71 \leq Rho_n \leq 1.16$	kg/m ³
H₂ content	H_2	(xH2)	$0 \leq H_2 \leq 10.0$	Mol-%
CO₂ content	CO_2	(xCO2)	$0 \leq CO_2 \leq 30.0$	Mol-%

 Mol-% = Molar content expressed in percent (0-100%)

 The entry of the standard density Rho_n must be referenced to the standard temperature of 273.15 K and the standard pressure of 1.01325 bar. With a change of the standard temperature or of the standard pressure (in the menu: Reference quantities DS: 135) the standard density to be entered must be converted.

Furthermore the following limits must be ensured by the operator:

Methane	CH_4	50-100%	Propane	C_3H_8	0-5%
Nitrogen	N_2	0-50%	Butane	C_4H_{10}	0-1%
Ethane	C_2H_6	0-20%	Pentane	C_5H_{12}	0-0.5%

Range limits for AGA-NX-19:

In the case of computation using **AGA-NX-19** the content xN2 is displayed instead of the xH2 and instead of the standard density Rho_n , the density ratio dv.

For natural gases with a **low calorific value** the following limits apply:

Calorific value	$H_{o,n}$	(Hon)	$8.833 \leq H_{o,n} \leq 11.055$	kWh/m ³
Density ratio	dv	(dv)	$0.5540 \leq dv \leq 0.7500$	1
CO₂ content	CO_2	(xCO2)	$0 \leq CO_2 \leq 15.00$	Mol-%
N₂ content	N_2	(xN2)	$0 \leq N_2 \leq 15.00$	Mol-%

For natural gases with a **high calorific value** the following limits apply:

Calorific value	$H_{o,n}$	(Hon)	$11.055 < H_{o,n} \leq 12.833$	kWh/m ³
Pressure	p		$0 \leq p \leq 80$	bar
Temperature	T		$-5.0 \leq T \leq 35$	°C
Density ratio	dv	(dv)	$0.5540 \leq dv \leq 0.6910$	1
CO₂ content	CO_2	(xCO2)	$0 \leq CO_2 \leq 2.50$	Mol-%
N₂ content	N_2	(xN2)	$0 \leq N_2 \leq 7.00$	Mol-%

 *With the density ratio dv the entry is independent of the standard temperature and pressure.*

Furthermore the following limits for natural gases with a high calorific value must be ensured by the operator:

Methane	CH_4	>82%	Propane	C_3H_8	0-4.5%
Ethane	C_2H_6	0-12%	Hydrogen	H_2	0-4%

With temperatures from -5°C...0°C and 30°C...35°C the warning “E43 - Correction: Temperature value warning limit” is output. Below -5°C and above 35°C the alarm “E42 - Correction: Impermissible temperature value” is output, correction takes place using the substitute K value and counting occurs in the disturbance volumes. If 80 bar is exceeded, the fault “E32 - Correction: Impermissible pressure value” is output and counting also takes place in the disturbance volumes.

3.6.1 Gas analysis log book

In the sub-list “**Gas analysis log book**” earlier valid values of the gas quality can be checked (so-called Gas Analysis Log Book). This is particularly important with remote adjustment of the gas analysis values, e.g. via the DSfG bus, because it is only then that tracing of the values is possible. The last 16 changes with time notation of the change are always retained.

After calling the log book, the dates, beginning with the last change, can be called up consecutively with the arrow key “↓”. The corresponding values are called with the “Enter” key.

 *The changed values must then be entered in the design data book from time to time.*

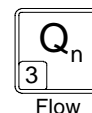

3.7 Flow list

AD	Designation/value	Value range	Units	Default	C/U	HLP	Ref.remark
Qn	Standard flow	999'999.9	m ³ /h	-	-	H13	
Q	Actual flow	99'999.9	m ³ /h	-	-	H12	
Q-Dat	Time of min/max measurement	12.12.12 / 12:12	-	-	-	-	1
Qnmin	Minimum measurement of Qn	99'999.9	m ³ /h	-	-	H17	2
Qnmax	Maximum measurement of Qn	999'999.9	m ³ /h	-	-	H15	2
Qmin	Minimum measurement of Q	9'999.9	m ³ /h	-	-	H16	2
Qmax	Maximum measurement of Q	99'999.9	m ³ /h	-	-	H14	2
Q-Clr	Reset measurement acquisition	-	-	-	-	-	3
QnLLi	Lower warning limit for Qn	0...99'999.9	m ³ /h	0,0	U	P16	4
QnULi	Upper warning limit for Qn	0...999'999.9	m ³ /h	25'000.0	U	P15	4
QLLi	Lower warning limit for Q	0...9'999.9	m ³ /h	0,0	U	P20	4
QULi	Upper warning limit for Q	0...99'999.9	m ³ /h	2'500.0	U	P19	4
QHyst	Hysteresis warning limits Qx	0.5...99.9	%	0.5	U	P204	5

AD = Abbreviated designation

C/U = Calibration/user lock

HLP = Identification in value number protocol

DDS = Design data sheet

Remarks:

- 1 Start of acquisition of the following listed min/max measurements for the standard and actual flows.
- 2 The standard and actual flows are continuously monitored and their minima and maxima are saved with a time stamp.
- 3 The measurements can be reset via this point and the acquisition restarted.
- 4 Violation results in a warning (faults E52 - E55) taking the hysteresis into account.
- 5 With Q_{ULi}/Q_{LLi} the hysteresis refers to x% of Q_{max} and with Q_{nULi}/Q_{nLLi} it refers to x% of the product of $Q_{max} \cdot p_{max}$. It is only required for the warning limits. The warning is given when the warning limit ($QxULi$) plus half the hysteresis is exceeded and it is reset when the warning limit minus half the hysteresis is undercut.

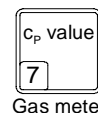

3.8 Gas meter list

AD	Designation/value	Value range	Units	Default	C/U	HLP	Ref.remark
cp1	cp value, Pulse Gen. 1	0.0001..99999.999	1/m ³	1764.0	C	P4	1
GTyp1	Mode, Pulse Gen. 1	AUTO / HF / LF	-	AUTO	C	P202	2
Gen2	Gen. 2 connected	yes / no	-	yes	C	P37	
cp2	cp value, Pulse Gen. 2	0.0001..99999.999	1/m ³	1764.0	C	P5	1
GTyp2	Mode, Pulse Gen. 2	AUTO / HF / LF	-	AUTO	C	P203	2
Dev12	Permissible gen. deviation	0.5...99.9	%	5	U	P201	3
LineB	Line breakage monitoring 1/2	2x yes/ no	-	no/no	C	P36	4
GTyp	Gas meter size	G16...G16000	-	G1600	C	P200	5
SN-M	Gas meter ser. no.	123456789012	-	-	C	L124	
QMod	Mode for Qmin monitoring	Alarm/Info	-	Info	C	P41	6
Qmin	Lower alarm/info limit for Q	0...9'999.9	m ³ /h	125.0	C/U	P7	6,7
Qmax	Upper alarm limit for Q	0...99'999.9	m ³ /h	2'500.0	C	P6	7
Qlf	Q limit for run-up and run-down times	0...9'999.9	m ³ /h	0,0	C/U	P207	8
ton	Gas meter run-up time	000...999	min	0	C/U	P205	8,9
toff	Gas meter run-down time	000...999	min	0	C/U	P206	8,9

AD = Abbreviated designation

C/U = Calibration/user lock

HLP = Identification in value number protocol

DDS = Design data sheet

Remarks:

1 The entry of the c_p value occurs in various formats:

xxx,yyyyy min: 0.00001 1/m³

xxxx,yyyy

xxxxx,yyy max: 99999,999 1/m³

2 With the setting "**AUTO**" in the EK-87, the definition of the cut-off frequency and the differentiation of whether a high frequency generator (HF) or a low frequency generator (LF) is involved occurs automatically (see Chap. 3.8.1).

 For normal applications (without special supplementary equipment) the setting should be left on **AUTO**.

3 Only possible with the connection of two pulse generators; the deviation should not be set less than 5% (fracture of a vane); exceeding the limit produces faults E15 and E16.

- 4 Line breakage monitoring for Generators 1 and 2. Activation (= "yes") is only practicable for NAMUR generators.
- 5 Possible settings for gas meter type: G16, G25, G40, G65, G100, G160, G250, G400, G650, G1000, G1600, G2500, G4000, G6500, G10000, G16000 or S Type. The selection of the required approval type is made in the entry mode using the cursor key "→".
- 6 Settings are possible, subject to calibration regulations, of whether undercutting of Q_{min} leads to disturbance volume counting (alarm) or whether it is just treated as information.
- 7 Gas meter parameters.
- 8 The lower flow limit Q_{lf} (in the display: Q_{min} run up/down) indicates the end of the run-up time or the start of the run-down time. It is shorter or equal to the minimum flow Q_{min} and the actual threshold for the monitoring of Q_{min} . When operated with low frequency, the lower flow limit is automatically set to "0". "0" means that monitoring of the run-up/down time does not occur.
- 9 The entry "0" for the run-up **or** run-down time switches off the run-up **and** run-down control. This is an essential requirement for LF generators (E1 generators). Exceeding the run-up time is signalled as warning E22 and exceeding the run-down time produces warning E23. In addition, information E18 or the alarm E19 is output with the undercutting of Q_{min} .

3.8.1 Pulse input description

The pulse input card is designed according to **NAMUR specifications** and to be **intrinsically safe** (BVS 92.C.2039 X see Appendix A-1). The card is approved as **associated electrical operating equipment for Ex Zone 1**. This also means that generators located in Ex Zone 1 can be connected to the EK-87. The inputs are electrically isolated from the system, but not from one another.

Setting the operating mode

The EK-87 has two counter inputs (channels) for the connection of a maximum of two pulse generators from a gas meter. The inputs are designed both for high frequency pulses (HF generators) as well as for low frequency pulses (LF generators) and also for mixed operation of an HF and an LF generator. With mixed operation the HF generator must be connected to the "**2+**"/"**2-**" input. In the operating mode with only one generator (HF or LF), it must be connected to the input "**1+**"/"**1-**". In addition Generator 2 must be removed from the "**Gas meter**" list.

Definition of the type of input and setting of the cut-off frequency

Since an HF or an LF generator can be connected to the inputs, different cut-off frequencies must be provided depending on the operating mode in order to prevent possible interference (e.g. contact bounce). With the setting of the input type to **AUTO** (default setting), these limits are determined directly and set by the EK-87. Differentiation is made according to the following conditions:

$$cp \cdot 1.8 \cdot Q_{\max} + 1 < 10 \text{ Hz} \quad \rightarrow \quad \text{LF generator; cut-off frequency} = 10 \text{ Hz}$$

$$cp \cdot 1.8 \cdot Q_{\max} + 1 \geq 10 \text{ Hz} \quad \rightarrow \quad \text{HF generator; cut-off frequency} = 3000 \text{ Hz}$$

e.g.: G40 E300); cp value = 200 pulses/m³; Q_{max} = 65m³/h

$$f = 200 \text{ pulses/m}^3 \cdot 1.8 \cdot 65 \text{ m}^3/\text{h}/3600 \text{ s/h} + 1 = 7.5 \text{ Hz} \quad \rightarrow \quad \text{LF generator}$$

The output of the warning “E11” or “E12” occurs if the frequency is higher than the frequency at $1.8 \cdot Q_{\max}$:

e.g.: Q_{max} = 65 m³/h (G40); cp value = 200 pulses/m³;

$$\rightarrow f_{(Q_{\max})} = 65 \text{ m}^3/\text{h} \cdot 200 \text{ pulses/m}^3 : 3600 \text{ s/h} = 3.611 \text{ Hz}$$

$$\rightarrow f_{(\text{warning})} = 1.8 \cdot f_{(Q_{\max})} = 1.8 \cdot 3.611 \text{ Hz} = 6.5 \text{ Hz}$$

This means that the warning is output at an input frequency of greater than 6.5 Hz.

In addition, there is the possibility in the EK-87 of being able to set the input type for each generator subject to the calibration lock to “**HF**” or “**LF**” for supplementary equipment located between the EK-87 and the generator (e.g. pulse summing devices) or for pulse generators which exhibit a very unfavourable mark-space ratio. In these cases the inputs can be set fixed as **HF** inputs (upper cut-off frequency = 3 kHz) and *all* pulses are counted) or as **LF** inputs (upper cut-off frequency = 10 Hz and disturbance pulses are *not* counted).

 *In normal applications (without supplementary equipment) it is essential to leave the setting at **AUTO**.*

Monitoring the generator deviation

With the connection of two generators monitoring of the deviation of the generator pulses occurs. This takes place irrespective of whether the same or different generators are used. Since the monitoring is weighted according to volume (enabling any cp values), a very long time may pass with a low permissible deviation and mixed operating mode before the fault message is output (e.g.: 10 pulses are needed at 10% and 100 pulses at 1% permissible deviation, producing long periods with LF

generators). With mixed operation and the failure of the HF generator it must be noted that the gas volume passed up to switching to the LF generator is lost (but with no loss of pulses).

Monitoring for the generator deviation is carried out up to the flow which corresponds to 1/50th of Q_{\max} .

 *With very low permissible deviations or the combination of HF/LF generators very long counting periods can occur under some circumstances until a fault message is produced (400 pulses for 0.4% deviation). With the combination of HF and LF generators **volume losses** can arise with the deviation of the HF generator until the fault detection switches over to the second channel.*

 *Normally the maximum deviation should not be less than 5% (-> loss of a vane is detected) so that small deviations in the flow computation do not already trigger fault detection.*

Line breakage monitoring

Each connected generator can be monitored for cable breakage. To do this, the line breakage monitoring for Generator 1 and, where necessary, Generator 2 must be set to “**yes**”. The EK-87 then checks from time to time whether a current greater than 0 mA flows in the pulse generator line. If this is not the case, the warning “E13 - Counter Input 1 failed” or “E14 - Counter Input 2 failed” is output.

With **NAMUR** generators this monitoring is important and should also be switched in. As supplied ex-works, the line breakage monitoring is switched off.

 *With switching contacts (reed contacts (E1 generators) and transistor switches) the line breakage monitoring should be switched off, because continual warnings would otherwise be produced (fault E13 and E14).*

Monitoring of run-up and run-down time

The **run-up time** is defined as the time from the turbine-wheel at rest to it exceeding the lower flow limit Q_{lf} (in the display: Q_{\min} run-up/-down) and the **run-down time** from undercutting the lower flow limit Q_{lf} to the turbine-wheel coming to rest. The entry “0” for the run-up **or** run-down time switches off the run-up **and** run-down time monitoring. This is essential with LF generators (E1 generators). Exceeding the run-up time is signalled as warning E22 and exceeding the run-down time as E23.

In addition, the information E18 or the alarm E19 (depending on the Q_{\min} mode) is output to signal the undercutting of Q_{\min} .

3.9 Measurement list

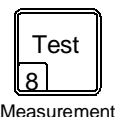

AD	Designation/value	Value range	Units	Default	C/U	HLP	Ref.remark
Test	Call of self-test function	-	-	-	-	P88	1
FR-M1	Set freeze mode Set 1	immediate	-	immediate	U	H162	2
FR-M2	Set freeze mode Set 2	immediate	-	immediate	U	H163	2
FR-A1	Display freeze values Set 1	H100 - H113	-	-	-	see l.	3
FR-A2	Display freeze values Set 2	H120 - H133	-	-	-	see l.	3
FR-Dif	Displ. freeze difference Set 1/2	H140 - H151	-	-	-	see l.	3
fG1	Input frequency Generator 1	0...3000 / 0...10	Hz	-	-	L23	
QG1	Moment. flow Generator 1	99'999,9	m ³ /h	-	-	L245	4
fG2	Input frequency Generator 2	0...3000 / 0...10	Hz	-	-	L24	
QG2	Moment. flow Generator 2	99'999,9	m ³ /h	-	-	L246	4
pBin	Binary value, pressure (before calibration)	approx. 3900...20500	-	-	-	L47	4
pAna	Analogue value, pressure (after calibr.)	approx. 3.9... 20.5	mA	-	-	L247	5
TBin	Binary value, temp. (before calibr.)	approx. 1000...12500	-	-	-	L48	4
TAna	Analogue value, temp. (after calibr.)	approx. 10... 125.00	ohm	-	-	L248	5
TDBin	Binary value, device temp.	00...150	-	-	-	L46	6
BaBin	Binary value, battery voltage	100...175	-	-	-	L56	6

AD = Abbreviated designation

C/U = Calibration/user lock

HLP = Identification in value number protocol

DDS = Design data sheet

Remarks:

- 1 Call of LCD test function and EK-87 self-test.
- 2 Settings for freezing the values (see Chap. 3.9.1 for description).
- 3 Display of the frozen values (Vn, V, Vnd, Vd, Vnt, Vt, p, T, Z, K, Qn, Q, date, time, reason for freezing).
- 4 Display of the corrected flow from the generator based on the input frequency and the cp value.
- 5 Binary values of A/D converter before calibration of the analogue card (see also Chap. 3.3.2/3.4.2).
- 6 Calibrated analogue values for the pressure/temperature input.
- 7 Binary values of A/D converter for service purposes.

3.9.1 Freeze function

3.9.1.1 Displaying the frozen values

Two sets of consumption data (with the difference between the two sets) can be retained separately or in dependence of one another using the freeze function. This function is intended, for example, for a check of the working point. The following values are frozen in each frozen set (sub-list “**Display frozen values Set 1/2**” or “**Display frozen difference values**”):

- Freeze mode and time
- Standard volume (V_n), disturbance standard volume (V_{nd}), total standard volume (V_{nt}),
- Actual volume (V), disturbance actual volume (V_d), total actual volume (V_t),
- Pressure (p), temperature (T), Z value (Z), K value (K),
- Standard flow (Q_n) and actual flow (Q).

3.9.1.2 Freeze conditions

There are numerous ways of freezing consumption values and these are selected in the points: “**Freeze mode Set 1**” or “**Freeze mode Set 2**”. By pressing the Enter key branching to the enter mode (cursor display) can occur to set the mode. Below the various methods are described (first with the same freezing conditions for Set 1 and Set 2):

a.) Immediate freezing:

If the condition “**immediate**” is active, then Set 1 or Set 2 can be frozen directly in the entry mode (cursor display) using the Enter key. This is then also the trigger, for example, to freeze Set 2 after a defined period of time.

b.) Cyclic freezing at a defined time:

After pressing the cursor key “→” in the entry mode, it is possible to execute the freeze function at a defined point in time. The possibilities for the cyclic freezing of Set 1 or Set 2 are as follows:

- “each year” on the date xx.xx at yy.yy hrs.
- “each month” on the xxth day at yy.yy hrs.
- “each day” at xx.xx hrs.
- “each hour” at the xxth minute.
- “every x hours” cycle (every 1, 2, 3, 4, 6, 8, 12 hours).
- “every x minutes” cycle (every 1, 2, 3, 4, 5, 6, 10, 12, 15, 20, 30 minutes).

After the selection of the mode using the cursor key “→”, the exact date and time can be defined by pressing Enter key. Therefore, it is possible, for example, to trigger freezing on the 1st of each month at 6.30am.

c.) Time-dependent freezing (in addition for Set 2):

In Data Set 2 there is also the possibility of triggering the freeze function in dependence of Data Set 1. Therefore, there are two additional selections in the freeze condition for Set 2:

- x hours after Set 1
- x minutes after Set 1

The procedure is as follows:

Data Set 2 is to be frozen, for example, 2 hours after Data Set 1. To do this, the required settings in Freeze Set 2 are first carried out:

- 02 hours after Set 1.

Then the freeze condition for Set 1 must, for example, be set to “**immediate**”. Set 1 is frozen with the Enter key and the condition for Set 2 is “armed”. After 2 hours Set 2 is also frozen. Until the freeze condition for Set 2 is fulfilled, the values of an earlier freezing are displayed in the sub-list: “Display Frozen Set 2”.

d.) Volume-dependent freezing (in addition for Set 2):

In Freeze Set 2 there is the possibility of freezing in dependence of a volume increase in the actual volume counter V (test volume). The procedure is similar as described in the previous section, except that here a certain “**test volume**” is entered instead of the time. Freeze Set 2 is then frozen when, for example, 50 m³ of gas have passed since the freezing of Set 1 which must be triggered via the “**immediate**” setting.

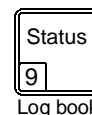

3.10 Disturbances / log book

AD	Designation/value	Value range	Units	Default	C/U	HLP	Ref.remark
ST-L4	Present status register	F:xxDate/time	-	-	-	L4	1
ST-L5	Acknowledgement list	F:xxDate/time	-	-	-	L5	2
Logb	Log book (approx. 200 entries)	F:xxDate/time	-	-	-	-	3

AD = Abbreviated designation

C/U = Calibration/user lock

HLP = Identification in value number protocol

DDS = Design data sheet

Remarks:

- 1 Present status register (Fxx flashing: Disturbance present; illuminated: Disturbance has passed, but has not yet been acknowledged).
- 2 All acknowledged faults in the sequence of their acknowledgement (summary of “start”, “finish” and “acknowledgement” of a fault).
- 3 Timed registration of past events (independent of error). Can be called via the value number protocol from value number L500 to L699.

3.10.1 EK-87 disturbances

The EK-87 is fitted with an automatic monitoring function. This includes the monitoring of the generator lines for line breakage, monitoring of measurements exceeding or undercutting levels and the checking of its own processor functions via various internal routines.

Difference between alarm, warning and information

An **alarm** is released when a fault has occurred which affects the volume correction. In this case, where applicable, the substitute value for the correction is used and the volumes determined counted in the disturbance volumes.

A **warning** is output when a user-specified quantity is violated (e.g. the maximum value for the current output). No disturbance volume counting occurs.

A further fault message is **information**. This fault has still less effect than a warning. It is not indicated via LEDs, but is only recorded in the disturbance register and log book as well as being output via a suitably programmed output. It is automatically deleted from the disturbance list when it is no longer active (without acknowledgement). It can then be called via the list: “Log book”.

If an error in operation occurs, the user is clearly informed of it via various forms of display:

- **Indicators in the display**

In the case of a fault it is indicated in the standard display (V_n). The display is overwritten until the fault is passed or a key for calling any value is pressed. The fault is displayed in the order of its consecutive number in the sequence.

- **Indication by light emitting diodes**

Two light emitting diodes on the front panel are used for showing direct status information; a **yellow** LED for **warnings** and a **red** LED for **alarms**. If one of the LEDs **flashes**, this means that the fault is present at the moment and a **continuous illumination** indicates that the fault has passed in the meantime (e.g.: if the flow has only been briefly exceeded).

As a further indication a **green** LED is used as a **mains** check, showing that the volume corrector is connected to the power supply.

- **Setting the warning / alarm output**

By appropriate configuration of the digital outputs messages can be passed to external devices (e.g. control station). As default, Output 1 on the EK-87 is configured as an alarm output (relay changeover contact). In addition, all other digital outputs can be configured with any fault messages (see Chapter 3.11).

Calling fault messages

All present or unacknowledged fault messages can be called in the list: “**Status**”. The faults are displayed in the sequence of their consecutive numbering. If no disturbance has occurred, the message appears “No fault”.

The case of a current or past fault is different. Here the fault is indicated in the form of a fault number (flashing: Fault is currently present; illuminated: Fault is past, but not yet acknowledged). The occurrence and passing of a fault are recorded. While the fault is present, it cannot be acknowledged. Only past faults can be acknowledged and accepted in the “**Acknowledgement list**”.

All events are also recorded in the “**Log book**”. Here the chronological sequence of the statuses is retained.

Procedure for calling and acknowledging faults:

- First you must branch to the current status register via “Status”.
- After pressing the “Enter” key there is the possibility of deleting all faults no longer present or of calling them individually and acknowledging them.
- With the selection of “Single acknowledgement” each fault can be called (with “start” and “finish” and also with “acknowledge” for past disturbances). A cursor is displayed (> Entry mode) and a certain fault can be found with the cursor keys “→” or “←”.
- After pressing the “Enter” key again, the fault appears in **plain text** followed by the start and finish of the disturbance and the acknowledgement can be carried out. This deletes the fault, entering it into the acknowledgement list and in the log book.
- The next fault can be displayed and, where required, deleted.

3.10.2 Volume corrector fault messages

Status	Fault message	A/W/I
E00	No fault present	-
E01	New system start	A
E02	Power failure	A
E03	Inconsistent data	A
E04	Memory fault during comparison	W
E05	Card slot fault	I
E06	Calibration lock open	I
E07	Data error in EEPROM	A
E09	Counter input faulty	A
E10	Loss of voltage on counter input	A
E11	Counter Input 1, frequency too high	A
E12	Counter Input 2, frequency too low	A
E13	Counter Input 1, faulty	W
E14	Counter Input 2, faulty	W
E15	Counter Input 1, suspect	W
E16	Counter Input 2, suspect	
E18	Minimum flow undercut	I
E19	Minimum flow undercut	A

Status	Fault message	A/W/I
E20	Max. flow exceeded	A
E22	Meter run-up time violated	W
E23	Meter run-down time violated	W
E24	Overflow, V counter	W
E25	Overflow, interval counter (DS-100)	I
E30	Pressure measurement faulty	A
E31	Alarm limit, pressure	
E32	Volume correction: pressure value impermissible	A
E33	Lower warning limit, pressure	W
E34	Upper warning limit, pressure	W
E40	Temperature measurement faulty	A
E41	Alarm limit, temperature	A
E42	Volume correction: temperature value impermissible	A
E43	Volume correction: temperature value warning limit	W
E44	Lower warning limit, temperature	W
E45	Upper warning limit, temperature	W
E50	Pulse buffer overflow	I
E51	Info limit, current output	I
E52	Lower warning limit Q	I
E53	Upper warning limit Q	I
E54	Lower warning limit Qn	I
E55	Upper warning limit Qn	I
E56	Warning limit V DS100	W
E57	Warning limit Vn DS100	W

Note: A = Alarm; W = Warning; I = Information.

Description of fault messages

E01 New system start (ALARM)

SERVICE

The EK-87 has executed a new start with the acceptance of standard parameters (e.g. during a software update). Therefore, it is essential to check all values and the **adjustment** after this error message.

E02 Power failure (ALARM)

-

The power supply has been interrupted. If power failures occur frequently, then the procurement of an uninterruptible power supply (UPS) should be considered. All the data is retained; consumption measurement and volume correction are not however carried out.

E03 Inconsistent data (ALARM)

SERVICE

During an internal comparison process, it was found that the parameters which are retained two-fold in the EK-87 no longer match. This is a “severe fault” because the programmed settings are no longer guaranteed. The fault may be able to be corrected by changing a parameter and accepting it. Then the set parameters should be checked.

E04 Memory fault during comparison (Warning)

All counters in the EK-87 are stored threefold. If one counter differs from the two others having the same values, fault E04 is output. The memory location is then overwritten with the correct value. If none of the counters match, fault E03 is output.

The error is also output when parameters have been changed but not accepted after a longer period of time or when the maximum flow has been exceeded (Error: “E20”).

E05 Card-slot fault (Information)

SERVICE

If an input or output card can no longer be correctly addressed, fault E05 is output. If a card is defective, a number of faults are usually output. This enables the defective card to be localised:

E13 or E14 Pulse input card defective

E30 or E40 Analogue output card defective

Faulty output cards can be detected in the output list for the current status by the output of “??”.

E06 Calibration lock open (Information)**Calibration official**

Parameters subject to calibration regulations can be changed with the switch open. The switch must be closed and sealed for operation. This can only be carried out by the calibration official.

E07 Data error in EEPROM (ALARM)**SERVICE**

After parameters had been changed they were not able to be written to EEPROM (e.g. due to a power failure). Or after a power failure or a software update this data could not be read correctly. This error should be remedied by changing a value and again accepting the changed parameters. Then check all values. If this error occurs again, the EEPROM is defective (-> Service).

E09 Counter input faulty (ALARM)**SERVICE/see other messages**

This a "collective fault". It indicates that the measurement of the actual volume can no longer take place due to various reasons. The fault is output depending on the number of pulse generators used. With **one connected generator** this message is output if at least one of the following faults is present:

- E10 - Loss of voltage on counter input
- E11 - Counter Input 1, frequency too high
- E13 - Counter Input 1 faulty
- E20 - Max. flow exceeded

With **two connected generators** this message is output when at least one of the following faults is present:

- E10 - Loss of voltage on counter input
- E11 - Counter Input 1, frequency too high **and** E12 - Input 2, frequency too high
- E13 - Counter Input 1 faulty **and** E14 - Counter Input 2 faulty
- E20 - Max. flow exceeded

E10 Loss of voltage on counter input (ALARM)**SERVICE**

The NAMUR supply has failed on the pulse input card. Replacement of the card may be necessary.

E11 Counter Input 1, frequency too high (Warning)

The EK-87 computes the maximum permissible frequency from 1.8 x frequ. of the maximum flow Q_{max}. Exceeding this limit results in fault E11. If this fault could not have been produced by the system, then the pulse input card or the meter tapping point may be defective.

E12 Counter Input 2, frequency too high (Warning)

Analogous to E11 for Counter Input 2.

E13 Counter Input 1 faulty (Warning)

A line breakage has been detected on Counter Input 1. With counter inputs that are not designed according to NAMUR, this fault occurs more frequently; if required, switch off the line breakage monitoring in the gas meter list. The link must be checked for NAMUR generators.

E14 Counter Input 2 faulty (Warning)

Analogous to E13 for Counter Input 2.

E15 Counter Input 1 suspect (Warning)**E16 Counter Input 2 suspect (Warning)**

The specified deviation has been exceeded during a comparison of the two pulse inputs. That input which has counted the lowest volume is designated as being suspect. The second input is then used for the volume measurement.

IMPORTANT: The partial volume that has entered up to the switchover to the second generator is lower than the actual volume (but no loss of pulses). This applies particularly for mixed generators (HF and LF). The meter sensor system should be checked.

E18 Minimum flow undercut (Info)

If the setting of the Qmin monitoring mode is "Info", the info is output when $Q_{\min \text{ run up/down}}$ and not $Q_{\min} (!)$ is undercut after the set run-up respectively run-down time.

E19 Minimum flow undercut (ALARM)

When set as "Alarm", the alarm is output directly (with disturbance volume counting) if $Q_{\min} (!)$ is undercut.

E20 Maximum flow exceeded (ALARM)

A flow has been measured that is higher than $1.1 \times Q_{\max}$.

E22 Run-up time counter violated (Warning)

The period t_{on} , which is specified for run-up from a flow of $Q = 0$ to the set lower flow limit $Q_{\min \text{ run up/down}}$ has been exceeded. E18 or E19 is also output.

E23 Run-down time counter violated (Warning)

The period t_{off} , which is specified for run-down from undercutting the lower flow limit $Q_{\text{min run up/down}}$ to turbine standstill, has been exceeded. E18 or E19 is also output.

E24 Overflow, V counter (Warning)

The 8-figure counter for the actual volume (V) has produced an overflow (from 99,999,999 to 00,000,000).

E25 Overflow, interval counter (Warning)

In the data storage function an interval counter has overflowed. The interval value found is incorrect. The measurement period (interval period) or the data cp value should be corrected in order to avoid an overflow.

E30 Pressure measurement faulty (ALARM)**SERVICE**

This fault occurs when the measured current to the pressure sensor is lower than 3 mA or higher than 20.2 mA or if the voltage supplied to the pressure sensor is outside its tolerance. The substitute value for pressure is used for processing. Possible causes are: Input card defective, line breakage, short circuit in pressure sensor or defective pressure sensor.

The fault due to the current limits is not output when the calibration lock is open, but there is still a defective power supply.

E31 Alarm limit, pressure (ALARM)

The measured pressure is outside the alarm limits specified for the pressure sensor. The substitute value for pressure is used for processing. The fault is not output when the calibration lock is open.

E32 Volume correction, pressure value impermissible (ALARM)

The measured pressure exceeds 120 bar where computation of the K factor is carried out according to GERG-88 or 80 bar where AGA-NX-19 (H gas) is used. The fault is only output for a flow not equal to zero. -> Substitute K value.

E33 Lower warning limit, pressure (Warning)**E34 Upper warning limit, pressure (Warning)**

The measured pressure is lower than the lower warning limit specified in the pressure sensor list minus half the hysteresis, or respectively, it exceeds the spec. upper warning limit plus half the hysteresis.

E40 Temperature measurement faulty (ALARM)

This fault occurs when the measured resistance of the temperature sensor is lower than 18.6 ohm or higher than 125.24 ohm or if the voltage of the supply to the temperature sensor is outside its tolerance. The substitute value for the temperature is used for processing. Possible causes are: Input card defective, line breakage, short circuit in temperature sensor or defective temperature sensor.

The fault due to the limits is not output when the calibration lock is open, but there is still a defective power supply.

E41 Alarm limit, temperature (ALARM)

The measured temperature is outside of the limits specified for the temperature sensor without taking into account any hysteresis. The substitute value for temperature is used for processing.

The fault is not output when the calibration switch is open.

E42 Volume corrector, temperature value impermissible (ALARM)

The measured temperature is lower than -10.0°C where computation of the K value is carried out according to GERG-88 or lower than -5.0°C where AGA-NX-19 (H gas) is used or it exceeds 62.0°C for GERG-88 or 35°C for AGA-NX-19 (H gas). The fault is only output for a flow not equal to zero. The substitute K value is used for the further computation.

E43 Volume corrector, temperature value warning (Warning)

The measured temperature is lower than 0.0°C for AGA-NX-19 (H gas) or higher than 30.0°C for AGA-NX-19 (H gas). The fault is only output for a flow not equal to zero. The fault has no effect on the processing.

E44 Lower warning limit, temperature (Warning)**E45 Upper warning limit, temperature (Warning)**

The measured temperature is lower than the lower specified warning limit minus half the hysteresis, or respectively, it is higher than the upper warning limit plus half the hysteresis.

E50 Pulse buffer overflow (Information)

A maximum output frequency is specified for the output of pulses. If all pulses cannot be output at a certain point in time, they are stored temporarily and, if necessary, output later. If one of these output counters reaches the value of

1000, then fault E50 is output. This fault can be prevented by correction of the relevant output scaling or by increasing the maximum frequency.

E51 Info limit, current output (Information)

This fault is output if, due to the programmed scaling, a current lower than 0 or 4 mA or greater than 20 mA would have had to be output on one of the analogue outputs. The output, however, remains at its physical limit. The fault can be also be avoided here by correcting the relevant output scaling. The output of the message can be suppressed when assigning the analogue output (e.g. practicable with changeover systems since one line is always not operating and the standard display would be overwritten).

E52 Lower warning limit, Q (Warning)

E53 Upper warning limit, Q (Warning)

The actual flow Q is lower than the lower specified warning limit minus half the hysteresis, or respectively, it exceeds the spec. upper warning limit plus half the hysteresis.

E54 Lower warning limit, Qn (Warning)

E55 Upper warning limit, Qn (Warning)

The standard flow Qn is lower than the lower specified warning limit minus half the hysteresis, or respectively, it exceeds the spec. upper warning limit plus half the hysteresis.

E56 Warning limit V DS100 (Warning)

The alarm limit set using the AS-100 (interval or daily limit) in Channel 1 (V) has been exceeded. The flow of the interval or the day was too large.

E57 Warning limit Vn DS100 (Warning)

The alarm limit set using the AS-100 (interval or daily limit) in Channel 2 (Vn) has been exceeded. The flow of the interval or the day was too large.



3.11 Output list

AD	Designation/value	Value range	Units	Default	C/U	HLP	Ref.remark
DO1	Current assignment DO1	Switch./ pulse	-	Switch.	U	P 310	1
DO1an	Check status + output	Depends on assignment	-	-	U	P 316	1
DO1	New assignment DO1	Switch./ pulse	-	Alarm	U	P 310	1
DO1Pu	Pulse value DO1	0.001...9'999.999	m ³ /pul.	-	U	P 317	3
DO1Lo	Logic DO1	NO/NC contact	-	NO contact	U	P 314	2,4
DO1fr	Max. output frequency DO1	1...10	Hz	-	U	P 312	3,7
DO2	Current assignment DO2	Switch./ pulse	-	Pulse	U	P 320	1
DO2an	Check status + output	Depends on assignment	-	-	U	P 326	1
DO2	New assignment DO2	Switch./ pulse	-	Vnt	U	P 320	1
DO2Pu	Pulse value DO2	0.001...9'999.999	m ³ /pul.	10	U	P 327	3
DO2Lo	Logic DO2	NO/NC contact	-	-	U	P 324	2,4
DO2fr	Max. output frequency DO2	1...10	Hz	5	U	P 322	3
DO3	Current assignment DO3	Switch./ pulse	-	Pulse	U	P 330	1
DO3an	Check status + output	Depends on assignment	-	-	U	P 336	1
DO3	New assignment DO3	Switch./ pulse	-	Vnt	U	P 330	1
DO3Pu	Pulse value DO3	0.001...9'999.999	m ³ /pul.	10	U	P 337	3
DO3Lo	Logic DO3	NO/NC contact	-	-	U	P 334	2,4
DO3fr	Max. output frequency DO3	1...10	Hz	5	U	P 332	3
DO4	Current assignment DO4	Switch./ pulse	-	Pulse	U	P 340	1
DO4an	Check status + output	Depends on assignment	-	-	U	P 346	1
DO4CU	DO4 subject to calibration/ user lock	C/U	-	U	C	P 345	5
DO4	New assignment DO4	Switch./ pulse	-	Vn	U	P 340	1
DO4Pu	Pulse value DO4	0.001...9'999.999	m ³ /pul.	10	U	P 347	3
DO4Lo	Logic DO4	NO/NC contact	-	-	U	P 344	2,4
DO4fr	Max. output frequency DO4	1...10	Hz	5	U	P 342	3
DO5	Current assignment DO5	Switch./ pulse	-	Pulse	U	P 350	1
DO5an	Check status + output	Depends on assignment	-	-	U	P 356	1
DO5CU	DO5 subject to calibration/ user lock	C/U	-	U	C	P 355	5
DO5	New assignment DO5	Switch./ pulse	-	V	U	P 350	1
DO5Pu	Pulse value DO5	0.001...9'999.999	m ³ /pul.	10	U	P 357	3
DO5Lo	Logic DO5	NO/NC contact	-	-	U	P 354	2,4
DO5fr	Max. output frequency DO5	1...10	Hz	5	U	P 352	3

Continued on next page.

AD	Designation/value	Value range	Units	Default	C/U	HLP	Ref.remark
AO1	Current assignment AO1	Qn, Q, p, T	-	Qn	U	P510	
AO1an	Check status of AO1 + output	0.000...20.000	mA	-	-	P514	
AO1	New assignment AO1	Qn, Q, p, T	-	-	U	P510	
AO1LV	Lower ref. val. AO1 (0/4 mA)	See remarks	See remarks	0.0	U	P512	6
AO1UL	Upper ref. val. AO1 (20 mA)	See remarks	See remarks	25'000.0	U	P511	6
AO1Mo	Mode, lower ref. val. AO1	0/4..20	mA	0...20 mA	U	P513	
AO1E	Suppression of E51	Yes/No	-	Yes	U	P515	8
AOx	Current assignment AOx	Qn, Q, p, T	-	Q	U	P5x0	9
AOxan	Check status of AOx + output	0.000...20.000	mA	-	-	P5x4	9
AOx	New assignment AOx	Qn, Q, p, T	-	-	U	P5x0	9
AOxLV	Lower ref. val. AOx (0/4 mA)	See remarks	See remarks	0.0	U	P5x2	6,9
AOxUL	Upper ref. val. AOx (20 mA)	See remarks	See remarks	2'500.0	U	P5x1	6,9
AOxMo	Mode, lower ref. val. AOx	0/4..20	mA	0...20 mA	U	P5x3	9
AOxE	Suppression of E51	Yes/No	-	Yes	U	P5x5	8,9

AD = Abbreviated designation

HLP = Identification in value number protocol

C/U = Calibration/user lock

DDS = Design data sheet

Remarks:

- Possible if assigned as **switching output**:
Alarm / Warning / Information / Time synchr. output or special error;
as **pulse output**: Vn, V, Vnd, Vd, Vnt or Vt.
- Setting as normally open contact (NO) / normally closed contact (NC) and present message / unacknowledged message possible.
- Only obtained if assigned as pulse output.
- Only obtained if assigned as switching output.
- The output can be secured subject to the calibration lock for pulse outputs under calibration regulations.
- Ranges and units of analogue outputs:
Qn: 0...999,999.9 m³/h Q: 0...99,999.9 m³/h
p: 0...120.000 bar T: -12...+60°C
- Relay output, maximum frequency: 1 Hz
- Option of suppressing the message: Information limit, current output (E51)
- Depending on the analogue output card: x = 2; resp. x = 2 to 43.11.1
Switching and pulse outputs

3.11.1 Switching and pulse outputs

The digital output card (DIA5) is used for the output of alarm, warning or limit messages or as a pulse output for following devices. The outputs are electrically isolated from the system and separated from one another and can be wired in parallel if required. Each output can be programmed as required.

Relay output (DO1)

The output DO1 has a special feature: It is a **relay changeover contact** and therefore offers the possibility of permitting a larger current flow, connecting alternating voltage and of giving a signal for voltage failure.

It must be noted that the relays have a limited speed and have a maximum output frequency of less than 1.0 Hz.

The terminals are labelled as 1O (normally closed), 1S (normally open) and 1W (changeover contact).

Transistor outputs (DO2 - DO5)

The **transistor outputs** on the digital pulse output card are electrically isolated via optocouplers to the system and to one another. They are intended as switching outputs (e.g. for limit signals), error outputs (for general or certain error signals) and as pulse outputs (e.g. for the standard volume). As supplied ex-works, they are assigned 2 x **standard volume V_n (DO2 and DO4)** and 2x **actual volume V (DO3 and DO5)**. Also here it is possible to assign each output to a certain value and to wire outputs in parallel.

The terminals are labelled 2+/2- to 5+/5-. The outputs DO4 and DO5 also have the possibility of setting the assignment and scaling subject to calibration regulations, for example, in order to obtain pulse outputs for applications where calibration is required. In addition, they are brought out to a separate connector.

It should be noted that these outputs are only designed for direct voltage (max. 28.8 VDC) and a maximum current of 50 mA. The maximum frequency of the transistor outputs is 10 Hz.

Designation of an output as a switching output

The current designation of the output (here: switching output) is displayed first in the output list and then after pressing the cursor key “↓” once, also the associated value.

Then the current status (open, closed) is displayed and there is the possibility, with the user lock open (with DO4 and DO5, where applicable, the calibration lock), of switching the outputs on or off (→ Test function). On leaving the menu, the output returns to its original status.

The output can then be reassigned if required.

With the value “**Digital output x - new**”, if the output is defined as a switching output, the output can be assigned with the following values:

- **Any alarm**
- **Any warning**
- **Any information**
- **As time-synchronous output**
- **A certain fault signal**

With the designation as time synchronous output, the output produces a pulse of one second duration every xx min. (selectable between: 5, 10, 15, 20, 30 or 60 min). It switches over, for example, at 12:15:00 and back again at 12:15:01.

The possible faults which can be assigned to the output are described in Chapter 3.10.2.

Whether a positive edge or a negative edge is required or if the signal is output, can be set using “**Dig. output x logic**” (NO = pos. edge; NC = neg. edge):

- **NO contact with alarm present**
- **NO contact with unacknowledged contact (corresponds to ALARM LED)**
- **NC contact with alarm present**
- **NC contact with unacknowledged alarm**

Important: Various points cannot be obtained depending on the designation.

b.) Designation of an output as a pulse output

If a pulse output is defined in the output list under the current designation, the associated value is also displayed also after pressing the cursor key “↓”.

Then the current status (“**x/s buffer:xxxx**”) is displayed. The display “x/s” indicates with which frequency pulses are currently being output and the display “Buffer” shows values in the temporary store:

If a larger number of pulses occurs which must be output (e.g. with LF generators, if a pulse enters with high pressure) - the setting of the pulse output, for example, only permits a maximum of 1 Hz - the pulses must be temporarily stored and output at a point in time when less volume arises (e.g. with longer pauses between pulses). This ensures that no output pulses are lost and pulse packets are avoided as far as possible. The number of the pulses still to be output is displayed under "**Buffer: xxx**". A maximum of 999 pulses can be retained.

 *If the number of pulses still to be output becomes greater than 999, the information "E50 - Pulse buffer overflow" is entered in the log book and output at a programmed output. If this state occurs, output pulses are lost.*

This can be prevented by changing the weighting of the output or by increasing the permissible output frequency.

 *The retained pulses are reset to "0" by "Accept parameters".*

With the user lock open (with DO4 and DO5, the calibration lock where applicable), branching to the test function can be made by pressing the "Enter" key. By pressing the "Enter" key again a fixed frequency can be output via the output (up to the maximum permissible frequency - see below). Also here the original state is re-established by leaving the display.

Then the output can be re-assigned if required.

If the output is defined as a pulse output with the display "**Digital output x - new**", the output can be assigned with the following values:

- **Actual volume, undisturbed** V
- **Standard volume, undisturbed** V_n
- **Actual volume, disturbed** V_d
- **Standard volume, disturbed** V_{nd}
- **Actual volume, total** V_t
- **Standard volume, total** V_{nt}

The pulse value with which the volume is output is defined under "**Dig. output x pulse val.**".

Then the maximum output frequency is set. This also sets the pulse length (T) of the output pulses:

$f_{\max} = 1 \text{ Hz}$	\rightarrow	$T = 500 \text{ ms}$	$f_{\max} = 2 \text{ Hz}$	\rightarrow	$T = 250 \text{ ms}$
$f_{\max} = 3 \text{ Hz}$	\rightarrow	$T = 166 \text{ ms}$	$f_{\max} = 4 \text{ Hz}$	\rightarrow	$T = 125 \text{ ms}$
$f_{\max} = 5 \text{ Hz}$	\rightarrow	$T = 100 \text{ ms}$	$f_{\max} = 6 \text{ Hz}$	\rightarrow	$T = 83 \text{ ms}$
$f_{\max} = 7 \text{ Hz}$	\rightarrow	$T = 71 \text{ ms}$	$f_{\max} = 8 \text{ Hz}$	\rightarrow	$T = 62 \text{ ms}$
$f_{\max} = 9 \text{ Hz}$	\rightarrow	$T = 55 \text{ ms}$	$f_{\max} = 10 \text{ Hz}$	\rightarrow	$T = 50 \text{ ms}$

 Each output is completely programmable independent of the others. It is possible, for example, to output V_n in Channel 3 with 5 pulses per m^3 and in Channel 4 with 1 pulse per m^3 .

3.11.2 Analogue outputs (option)

The optional analogue output card with 2 or 4 outputs is used for the output of direct currents which are proportional to the actual or standard flow, to the measured or corrected pressure or to the measured or corrected temperature (e.g. for flow recorders).

The outputs are electrically isolated to the system, but not against one another (common ground). The outputs can be operated in the 0 - 20 mA or 4 - 20 mA modes and each output can be programmed as required. They are assigned ex-works to the **standard flow Q_n (AO1)** and **actual flow Q (AO2)** (with 4 outputs: **corrector pressure p (AO3)** and **corrector temperature T (AO4)**). Apart from the modes (0/4-20 mA) the scaling of each output can be set separately. Even a negative scaling is possible (e.g.: 0.0 mA \approx 10000 m^3/h and 20 mA \approx 100 m^3/h).

In the case of a fault the current is output for the corresponding analogue channel, corresponding to the programmed substitute value (for pressure or temperature). After a voltage failure the analogue outputs remain blocked for some time until they then assume the correct value.

The terminals are labelled with 1+/1- to 4+/4-.

Designation of the analogue output

The current designation of the output (Q_n , Q , etc.) is also first displayed in the output list.

Then the current state (corresponding to the value to be output (in mA)) is displayed and there is the possibility, with the user lock open, of outputting a test current via the outputs. If changeover to another display occurs, the output returns to its original state.

Then the output can be re-assigned if required.

The following analogue values can be output:

- **unassigned (i.e. the output is inactive)**
- **measurement pressure** **p, measurement**
- **corrector pressure** **p, present**
- **measurement temperature** **T, measurement**
- **corrector temperature** **T, present**
- **actual flow** **Q**
- **standard flow** **Q_n**

The quantities “measurement pressure” and “measurement temperature” reflect the values measured on the input and the quantities “corrector pressure” and “corrector temperature” are the calibrated quantities for the pressure and temperature.

Under “**Anl.A.x Low. val.**” and “**Anl.A.x Upp. val.**” the lower and upper reference values of the output are set. For example, a standard flow of 100.0 m³/h should correspond to a current of 4.0 mA whereas 1000.0 m³/h should correspond to a current of 20.0 mA. The limits can be freely programmed.

Under “**Anl.output x mode**” the lower limit is set between “0...20 mA” and “4...20 mA” with the cursor key “→”.

Reaching the programmed limits leads to the output remaining at the corresponding maximum or minimum value (no output of a substitute value) and the information “**E51 - Info limit, current output**” is produced.

This may not be desired with changeover systems because the EK-87 then writes the info message in the display. For this case, the message can be suppressed, (**E51 Monitoring**). This suppression can be set separately for each output, so that e.g. the limit message is to be output (E51 - Monitoring = “yes”) with an analogue output assigned to “Pressure”, but not for the output of the flow in another channel (E51 - Monitoring = “no”).

3.12 DS-100 function

3.12.1 Introduction to the data storage function

In the measurement and data chain within the Long-Term Pulse Acquisition System the DS-100 function (DS-100 High Flow Recording Device) has the task of gathering data “at the point of measurement”. The DS function therefore does not represent an independent device, but is instead a software module which operates similar to a 4-channel DS-100 in the EK-87 independent of the volume correction function. In contrast to a DS-100 device no additional external inputs are required. The data that is acquired is taken directly from the volume corrector module, measured and saved on a time-related basis. In the EK-87 the DS function is subdivided as follows:

Channel 1	Actual volume (V)	[m ³]
Channel 2	Standard volume (V _n)	[m ³]
Channel 3	Pressure (p)	[bar]
Channel 4	Temperature (T)	[K]

The storage available in the EK-87 enables acquisition of values occurring over a period of approximately 0.5 years with an interval of 60 min. With shorter intervals the available period is reduced correspondingly. Two different forms of input signals are processed within the DS function in the EK-87; the “digital” values (V and V_n) and the “analogue” values (pressure and temperature). This difference can be seen in the following processing:

With the “digital” values pulses are counted or counter readings transferred and with the “analogue” values averages are formed from them which are then saved in the corresponding channels.

a.) Processing of the digital values (Channel 1 = V; Channel 2 = V_n)

A DS-100 **device** acquires the pulses arriving at the input and saves them related to time. However, in the DS-100 **function** in the EK-87 the **meter readings** are taken directly from the volume corrector module, i.e. no separate input terminals are required, because the data is transferred directly within the equipment. This has the advantage that with transfer of the DS-100 data by a read-out device, modem or similar equipment, the **original meter readings [OMR]** of the calibrated volume corrector are always available. Therefore, the display factors of the volume corrector are used for the storage, display and data transfer of the meter readings. The display of the above mentioned values can therefore only be changed via the display factor of the volume corrector. The flow values are calculated from the difference of the meter readings from the beginning of the interval to the end of the interval.

A cp value, which can only be entered via an interface (e.g.: **AS-100** or **AS-200**), is used for the consumption values (interval values) and maxima. This must be selected such that with $1.1 \cdot Q_{\max}$ in Channel 1 (V) resp. $1.1 \cdot Q_{\max} \cdot p_{\max}$ in Channel 2 (V_n) and with the required interval period no pulse counter overflow (>4079 pulses) can be produced. This should be ensured when initialising the DS function using the AS-100 as follows:

Q_{\max}		cp value	
≤	40,79 m ³ /h	100	pulses/m ³
≤	407,9 m ³ /h	10	pulses/m ³
≤	4079 m ³ /h	1	pulses/m ³
≤	40790 m ³ /h	0,1	pulses/m ³
≤	407900 m ³ /h	0,01	pulses/m ³

The stated values refer to an interval period of 60 min. If the interval is reduced, the corresponding maximum flows are increased (e.g.: from 60 to 30 min -> doubles the maximum flow).

In the V_n channel (Channel 2) it must be ensured that the standard flow is substantially higher in dependence of the Z factor. A rule of thumb is that the maximum standard flow $Q_{n\max}$ is given by the product of Q_{\max} and p_{\max} :

$$Q_{n\max} \approx Q_{\max} \cdot p_{\max}$$

b.) Processing the analogue values (Channel 3 = p; Channel 4 = T)

A value range from 0 to 4079 is also available for saving the means in the analogue channels. Consequently, the means cannot be saved with any resolution, but must instead be limited to practicable values. This limits the value range which is needed for displaying the analogue value.

The resolution of the pressure within the DS function is found from the upper limit entered for the pressure sensor (alarm limit).

Upper pressure limit		Resolution
Upper limit between	0 ≤ 4 bar	1 mbar
Upper limit between	4 ≤ 8 bar	2 mbar
Upper limit between	8 ≤ 16 bar	4 mbar
Upper limit between	16 ≤ 32 bar	8 mbar
Upper limit between	32 ≤ 64 bar	16 mbar
Upper limit between	64 ≤ 120 bar	32 mbar

The temperature resolution is constant at 0.1 K. It is therefore possible to save the temperature as the absolute temperature in Kelvin. The temperature is converted to °C for display in the EK-87.

3.12.2 Display of the value in Channel 1 (V) and Channel 2 (V_n)

AD	Displayed value	Display	Units	Ref. remark
H1	Totaliser reading V/V_n of EK-87	8/9 figures	m^3	1
H2	Adjustable counter V_p / undist. counter reading V_n	8/9 figures	m^3	1,2
H3	Month-end reading of H2	Value/D/T	m^3	1,3
H3	Previous month-end reading of H2	Value/D/T	m^3	1,3
H4	Max. daily consumption in current month	Value/D/T	m^3	1,4
H4	Max. daily consumption in previous month	Value/D/T	m^3	1,4
H5	Max. flow in current month	Value/D/T	m^3	1,5
H5	Max. flow in previous month	Value/D/T	m^3	1,5
H6	Last interval consumption	4-figure	m^3	1,6
H7	Measurement period (interval)	5-60	min.	7
-	Data - cp value for interval values	in decades	pulses/ m^3	8
L124	Meter number (e.g. serial number of gas meter)	12-figure	-	9
L123	Customer number	12-figure	-	10
L125	Device number (e.g. serial number of EK-87)	12-figure	-	11
H14	Interval / daily limit	6-figure	m^3	12
H23	Status	O/E	-	13

AD = Abbreviated designation and identification in value number protocol

Value/D/T = Value with date and time

Remarks:

- 1 Display depends on selected display factor. The post-decimal places can be switched on and off in the volume corrector with the "Enter" key in the display V_{nt} or V_t or under "System display setting".
- 2 The **adjustable V counter** (see Chap. 3.2) is displayed under this value number in Channel 1 and the **undisturbed V_n counter** in Channel 2 of the volume corrector. Setting the counter in the DS-100 function via the read-out device is **not** possible. Any value can be entered into the adjustable counter in the VC for Channel 1 (see Chap. 3.2) for synchronising to the mechanical meter mechanism of the gas meter (-> replicating the genuine meter reading of the gas meter). In Channel 2 (V_n) this is fixed and cannot be changed.
- 3 The reading of the **adjustable V counter** for Channel 1 and of the **undisturbed V_n counter** for Channel 2 are saved on the 1st of each month at the change of the day (e.g.: 6:00 hrs) and can be called during the current month. In addition the previous month end reading of the counter is displayed.

- 4 Display of the maximum daily consumption of the current and of the last month. Both values are identified with "H4". This procedure is restarted at the beginning of each month.
- 5 The maximum interval flow of the current and the last month are displayed consecutively. Both values are identified with "H5". With interval periods of less than 1 hour, the value is measured via the interval and extrapolated to 1 hour.
- 6 Display of the last interval consumption. The display depends on the set cp value (see below).
- 7 The measurement period can be set separately by the read-out device for each channel (5, 10, 15, 20, 30 and 60 min.). A new measurement period is temporarily stored and only accepted when the next full hour is passed. The measurement period (interval) is permanently bound to the time, i.e. a 60 minute measurement period runs, for example, from 14:00:00 hrs. to 15:00:00 hrs.
- 8 The momentary valid data cp value is only used for saving the interval values. It is only displayed for checking and any modification is only possible via the read-out device (see Part 1, Chap. 3.5.1-a).
- 9 The meter number is used to identify the connected gas meter. It can, for example, be set to the serial number of the gas meter. As supplied ex-works the meter number is set to "2".
- 10 The customer number is used as the most important reference quantity in the following processing steps. Similar to the meter and the device number, it can only be set via the read-out device. Ex-works the customer number is set to "1". If the customer number "0" is used, this channel is not read out, but skipped, during the automatic read-out.

 ***Please not that for correct recognition of the consumption data in the evaluation software, entry of a customer number (e.g. "1") is essential.***

- 11 The device number identifies the channels of the DS-100 function and is set ex-works. Apart from one place it agrees with the serial number on the name-plate. The “ten thousands place” is always “0” on the name-plate, but represents the channel with the saved and displayed device numbers, e.g.:

Serial number on the name-plate: 1000001
Device number in Channel 1: 1010001
Device number in Channel 2: 1020001
Device number in Channel 3: 1030001
Device number in Channel 4: 1040001

 ***The device numbers set on delivery should normally not be changed. It should be noted that it is essential that the device numbers of the separate channels must be different.***

- 12 An interval limit or a daily limit for the consumption can be specified via the read-out device. It is only displayed; setting is only possible via the read-out device. Exceeding the limit produces the fault E56 for the V channel and E57 for the Vn channel. It is reset at the beginning of an interval or day.

- 13 Faults and warning messages are saved in the status register for each channel. In the display an overview of the existing faults is displayed. The display of the faults can be called in plain text using the “Enter” key.

After reading out the channel and the acceptance of data into the read-out device, the register content is deleted if the fault is no longer present. Existing faults are then immediately re-entered.

An explanation of the faults is given in Chapter 3.12.4.

3.12.3 Display of the values in Channel 3 (p) and Channel 4 (T)

AD	Displayed value	Display	Units	Ref. remark
H1	Present measurement, pressure / temperature	xxx,yyy	bar/°C	1,2
H2	Mean in current month	xxx,yyy	bar/°C	1,3
H3	Mean in last month	D/T/value	bar/°C	1,3
H3	Mean in month before last	D/T/value	bar/°C	1,3
H4	Min. interval mean in current month	D/T/value	bar/°C	1,4
H4	Min. interval mean in previous month	D/T/value	bar/°C	1,4
H5	Max. interval mean in current month	D/T/value	bar/°C	1,4
H5	Max. interval mean in month before last	D/T/value	bar/°C	1,4
H6	Mean in last measurement period	D/T/value	bar/°C	1,5
H7	Measurement period (interval)	5 - 60	min	6
-	Computation factor	decimal	-	7
L124	Meter number	12-figure	-	6
L123	Customer number	12-figure	-	6
L125	Device number	12-figure	-	6
H23	Status	0/Exx	-	6

AD = Abbreviated designation and identification in value number protocol

Value/D/T = Value with date and time

Remarks:

- 1 Display in Channel 3 (p): xxx,yyy and in Channel 4 (T): $\pm xx,yy$
- 2 The measurement transferred from the volume corrector to the DS-100 function is displayed and also used for the formation of the mean.
Differences in the display of the pressure and temperature in comparison to the values directly displayed by the volume corrector are possible, because the value matching (lower resolution of the DS-100 function for system reasons) of the last place in the DS display can deviate from the volume corrector display by ± 1 depending on the pressure range. With the display of the temperature a deviation of even $\pm 0.2^\circ\text{C}$ is possible, because the temperature is internally processed as an absolute temperature and is only converted to $^\circ\text{C}$ for the display.
- 3 The monthly mean is computed from the interval values. The monthly means of the current and last months and the month before last are displayed.

- 4 During the formation of the mean, the interval means are monitored continuously and the lowest and highest values with the date and time are stored. The values of the current and last month are displayed consecutively.
- 5 The DS-100 function computes the arithmetic mean for each interval from the measurements of pressure and temperature transferred from the volume corrector.
- 6 See Chapter 3.12.2, Points 9-11, 13 for the description of the values.
- 7 The valid computation factor for determining the pressure and temperature in the DS-100 function is displayed. The EK-87 automatically determines the computation factor of the pressure channel from the entered pressure range (see Chap. 3.3). It is permanently fixed at 0.1 in the temperature channel. Both computation factors are only shown for control purposes and it is not possible to change them.

3.12.4 DS-100 status register

Status	Fault message	Description
E0	No fault present	-
E1	New start	There is no data in the memory when the EK-87 is first switched on. The DS function is not yet acquiring data. This only occurs after the time has been set with the read-out device.
E2	Power failure	The power supply has failed after the DS function has been set into operation. No data has been acquired during this period; the saved data is however retained and the internal clock continues running.
E3	Wrong value	The interval counter has overflowed in Channel 1 or 2 (more than 4079 pulses per interval) or the values could not be acquired correctly in Channel 3 or 4. The fault can also be caused by a fault in the volume corrector. The interval value is incorrect!
E4	Substitute value	This message indicates that a substitute value has been used to form the interval value from the VC.
E5	Corrected value	This message is caused by a VC fault. The associated interval value is possibly correct.
E6	Data error in memory	The EK-87 has been found faulty by internal test functions. The VC is defective.
E8	Test point S	After putting the DS-100 function into operation, this fault must be acknowledged once.

 *The recorded fault messages can be reset by reading out with the read-out unit or by remote data transmission. For this to be effective, the faults must no longer be present and they must have been acknowledged in the volume corrector.*

Relationship: Volume corrector fault/warning and DS-100 status

The possibilities of displaying the fault messages in the DS function do not correspond to the comprehensive possibilities presented by the volume corrector module. The reason is that usually a number of volume corrector faults have the same effects in the corresponding channel of the DS function. This means that the fault messages are reduced to a few DS fault messages. The fault messages are stored and displayed until the next read-out operation, by for example the read-out device. In the data flow only the interval value is labelled in which the fault occurred.

Allocation of the VC fault messages (channel-specific)

No.	Volume corrector fault text	K1	K2	K3	K4
E01	New start of system (A)	1	1	1	1
E02	Power failure (A)	2	2	2	2
E03	Inconsistent data (A)	6	6	6	6
E04	Memory fault (A)	6	6	6	6
E10	Power failure on counter input (A)	3	3		
E11	Counter input 1 Frequency too high (W)	5	5		
E12	Counter input 2 Frequency too high (W)	5	5		
E13	Counter input 1 disturbed (W)	5	5		
E14	Counter input 2 disturbed (W)	5	5		
E15	Counter input 1 suspect (W)	5	5		
E16	Counter input 2 suspect (W)	5	5		
E20	Max. flow exceeded (A)	5	5		
E30	Pressure measurement disturbed (A)		4	4	
E31	Alarm limit, pressure (A)		4	4	
E32	Correction: Impermissible pressure (A)		4	4	
E40	Temperature measurement disturbed (A)		4		4
E41	Alarm limit, temperature (A)		4		4
E42	Correction: Impermissible temperature (A)		4		4

Note:

K1 - K4: DS-100 Channel 1 - 4.

The fault messages E1-5 are included in the data stream; Message E6 is only entered in the status register. All other volume corrector faults/warnings have no effect on the DS function and are not recorded.

3.12.5 Reading out the consumption data

 *Before logical values in the data storage function can be read out, the EK-87 and the DS function must be put into service (see Chap. 3.12.6).*

Connecting the read-out device

Normally, an **AS-100** or **AS-200** is used for reading out the DS-100 function in the EK-87. A suitable lead is included in the items supplied with the read-out devices. Before connecting the device it should be noted that no explosive gas mixture should be present during the read-out process.

 *Connection must only take place with the read-out device switched off. Also, if possible, the connectors on both devices should be screwed. This ensures a reliable read-out.*

Starting the read-out

Reading out with the AS-100 Read-out Device is described here as an example of reading out. With other devices the relevant operating instructions for the read-out device should be followed.

After starting the read-out with the key “**D**” on the AS-100, the present channel and the transferred blocks are shown in the display.

 ***Please note that the entry of a customer number (e.g. “1”) is essential and the device numbers of the separate channels must be different for the correct recognition of consumption data in the evaluation software.***

After the read-out the internal clock in the EK-87 is corrected and the fault register (status) of the DS function is cleared if necessary.

 *With a closed calibration switch the correction is only made within ± 20 seconds.*

3.12.6 Putting the DS function into operation

Various values in the data storage function must be set before reading out the consumption data:

- a.) Customer, meter or device number (B2)
- b.) Interval period (B0)
- c.) Data cp value (B0/B7)
- d.) Access recognition (B666)
- e.) Set day boundary (B21)
- f.) Set alarm limit (B11)
- g.) Set I/O mask (B6)

About a.) **Customer, meter or device number (B2)**

It is essential that these numbers are checked during setting up. It is mandatory that they are set to a valid value, e.g. "1", because otherwise no evaluation of the data is possible with the evaluation software. The **meter number** corresponds to the serial number of the connected gas meter and the **device number** corresponds to the serial number of the EK-87. Here, the 5th figure from the right identifies the relevant channel (1=V, 2=V_n, 3=p, 4=T). In order to ensure correct evaluation of the data, the device number must be different in all channels. All the numbers must be entered separately for each channel.

About b.) **Interval period (B0)**

The interval period is the interval during which the incoming volume pulses and the analogue values are stored. A change of the interval period is needed if more than 4079 pulses in the actual or standard volume channel occurs in one interval (Warning: "**E25 - Interval counter overflow**"). The interval period should then be shortened to the next shorter interval period; the following values are possible: 5, 10, 15, 20, 30 and 60 min.

It should be noted that a change in the interval period only becomes valid at the next full hour.

About c.) **Data cp value (B0/B7)**

The weighting with which the interval values, the previous day's consumption (H4) and the previous interval consumption (H6) contained in the consumption data are saved in Channel 1 (V) and Channel 2 (V_n) can be set with B0 and B7 on the AS-100. Possible values are:

0.01 0.1 1 10 100

It must be noted that the required cp values should be selected in dependence of the maximum flow (Q resp. Q_n) as follows for an interval period of 60 min. if overflow of the interval counter is to be avoided:

Q_{\max}		cp value (pulses/m ³)	Resolution (m ³ /pul.)
≤	40.79 m ³ /h	100	0.01
≤	407.9 m ³ /h	10	0.1
≤	4079 m ³ /h	1.0	1.0
≤	40790 m ³ /h	0.1	10.0
≤	407900 m ³ /h	0.01	100.0

By reducing the interval period (see below), the stated max. flow values are increased accordingly. It should be noted that a change of the cp value only becomes valid at the start of the next interval.

About d.) **Access code (B666)**

The function of the **access code** is similar to the user lock in the volume corrector. The values in the DS function can therefore only be changed with the same codes in the AS-100 and the EK-87. The access code is set to "00000000" ex-works and is therefore not active. If an access code is set in the EK-87 via B666 in the AS-100, it is essential that the following is observed:

 ***An access code once set can only be changed if it agrees with the access code of the connected AS-100. If this access code is forgotten, it can only be changed via B666 with an open calibration lock!***

About e.) **Set day boundary (B21)**

The start of the day for data storage can be changed via B21 in the AS-100. Ex-works this is set to 6:00 hours. It should be noted that the start of the day can only be set to full hours.

 ***Changing the day boundary results in a restart of the data storage function. A change is therefore only possible with the correct access code on the AS-100. If the boundary is changed, the data must be read out **beforehand**, because otherwise it is irretrievably lost.***

About f.) Set alarm limit (B11)

Daily or interval limits for the volume can be programmed with the read-out device for Channel 1 (V) and Channel 2 (V_n). Exceeding the limits produces the warnings “**E56 - Warning limit V DS100**” or “**E57 - Warning limit Vn DS100**”.

The interval limits are directly related to the set cp value and the interval period. This should be taken into account when entering the limits.

The warnings are immediately set when the limit is exceeded and reset after the end of the interval or at the programmed day boundary and a new monitoring cycle begins.

About g.) Set I/O mark (B8)

The I/O mark is a label in the data flow that indicates that a significant change has occurred, e.g. an I/O mark is set automatically after a change of the customer, meter or device number. This type of mark can also be set by the user under “B8” in the AS-100. It is termed a **fixed I/O mark**.

 *The reading out of the consumption data only occurs up to this fixed I/O mark and all other previous values are irretrievably lost.*

The following values **cannot** be set in the EK-87:

- h.) Adjustable counter (B0)
- i.) cp value in the analogue channel (B0/B7)
- k.) cpz value (B7)
- l.) Set unit (B20)

About h.) Adjustable counter (B0)

 The adjustable counters are only intended for DS-100 devices and older volume correctors. The entry of an adjustable counter causes a fault message in the read-out device! With AS-100 versions <V5.0 this leads to “Cancellation of the transmission” and no transfer of changed values occurs. From Version V5.0 this fault is displayed (“Command ‘75’ unknown”), but the other changes are accepted.

About i.) cp value in the analogue channel (B0/B7)

The entry of a cp value is not possible in the analogue channels (Channels 3 and 4). The storage and transfer of the analogue values takes place with the aid of a so-called “computation factor” which is permanently specified in the software.

About k.) cpz value (B7)

The cpz value reflects a non-decade cp value of the pulse input in some DS-100 devices. Since the volume corrector meter readings are passed directly to the DS function in the EK-87, the cpz value is not supported.

About l.) Set unit (B20)

The function “Set unit” has no meaning in the EK-87, because the units are fixed. These are m³ in Channel 1 (V) and Channel 2 (V_n), bar in Channel 3 (p) and °C in Channel 4 (T).

3.13 Outputting the process data

For applications in the fields of process control (e.g. temperature control) and remote data transmission, all important data from the volume corrector function can be called through the serial interface.

This supplementary function takes place independent of the DS-100 data communication. However, since only one interface is available, simultaneous operation is not possible. Alternative reading out of the DS function and transmission of the process data block is possible though. The interface is always **free of any interaction** affecting the volume correction. Further documentation is available for detailed information. The data is called through the read-out interface by transmitting the following ASCII character string:

SOH P 6 7 CR <data> ETB

The <data> is transmitted in the following sequence and format:

```
STX 186,ELS,EK-87,9516,zzzzzzzzzzzz,kkkkkkkkkkkk,ggggggg0gggg,
YMMDDhhmmss,111111111111Dxy,222222222222Dxy,33333D-2,
4444444Dxy,555555D-5,6666666Dxy,7777777777777777,8888888D-1,
999999D-1,%4711,LF CR ETX
```

Explanation of the symbols

SOH	01 _{hex}	Ctrl A	Start of communication frame
ETB	17 _{hex}	Ctrl W	Finish of communication frame. Any number of interrogations (P67 CR) are possible between SOH and ETB.
STX	02 _{hex}	Ctrl B	Introduces the data flow. From now on only characters in the ASCII table are output. The data delimiters are commas (2C _{hex}).
186			3 decimal numbers; no. of bytes to be transferred after the following "E" excluding the ETX at the end of the block. The commas are also counted.
ELS			Elster company logo.
EK-87			Device identification in plain text.
9516			Device identification (95 = EK-87) and software version no. (16 = V1.6).

zzzzzzzzzzzz	Meter number.
kkkkkkkkkkkk	Customer number.
ggggggg0gggg	Device number; 5th place from last = 0.
YYMMDDhhmmss	Current date and time.
111111111111Dxy	Standard volume, 12-figure integer number and single exponent figure with sign e.g.: 00000012345D-3 corresponds to 12.345 m ³ .
222222222222Dxy	Actual volume, 12-figure integer number with single exponent figure with sign e.g.: 000023627383D-2 corresponds to 236,273.83 m ³ .
33333D-2	Present gas temperature, 5-figure integer number with signed exponent e.g.: 27315D-2 corresponds to 273.15 K.
4444444Dxy	Present gas pressure, 7 figure integer number with signed exponent e.g.: 0101325D-5 corresponds to 1.01325 bar.
55555D-5	Present K factor, 6-figure integer number with signed exponent e.g.: 010000D-5 corresponds to K = 0.1
6666666Dxy	Present Z factor, 7-figure integer number with signed exponent; for Z factors $\geq 100 \rightarrow$ only D-4! e.g.: 0120000D-5 corresponds to Z = 1.20000
7777777777777777	Present contents of the 60-bit status register, 16 characters e.g.: 000000000000C001 corresponds to faults 1, 15 and 16.
8888888D-1	Present standard flow, 7-figure integer number with signed exponent e.g.: 0253279D-1 corresponds to 25,327.9 m ³ /h.
999999D-1	Present actual flow, 6-figure integer number with signed exponent e.g.: 015630D-1 corresponds to 1,563.0 m ³ /h.
%4711 4	hexadecimal numbers, checksum MOD 65536 for all transmitted ASCII characters after STX up to and incl. "%".
LF CR ETX	End of process data block (LF = 0A _{hex} , Ctrl J; CR = 0D _{hex} , Ctrl M; ETX = 03 _{hex} , Ctrl C).

3.14 Value number protocol

Another way of obtaining data from the EK-87 is the value number protocol. Using this function each EK-87 value can be called in a very simple protocol via the serial interface (e.g. by remote data transmission).

With the calibration or user lock open the values can also be set remotely. With the calibration lock locked, the interface always has **no effect** on the volume correction.

This function is independent of the process data block or of the DS-100 data communication. However, since only one interface is available, simultaneous operation is not possible. The alternate reading out of the DS function and transmission of the data in the value number protocol is possible though.

Further information on the value number protocol can be obtained from Elster Handel.

Switching the value number protocol on/off

The data can be called, for example, using a commercially available terminal program. The transmission parameters are: 4800,n,8,1. The protocol is activated by the character **01_h (Ctrl+A)** and deactivated by the character **17_h (Ctrl+W)**.

Data interrogation

The data is called via the value numbers (Hxxx, Lxxx or Pxxx) which clearly code each value. Each value number that can be called is entered in the tables in Chapter 3 (e.g. L1 = Present pressure). The value number entry must be terminated with **<CR>** or **<=>**.

Data output

The EK-87 responds with **<STX><LF> Value number = Value <LF><CR><ETX>**. Then a new interrogation can be started or, if required, the last transferred value modified.

Parameter entry

To change a parameter the new value is entered directly after the transfer of the old value and terminated with **<LF><CR>**. Text to be transferred is coded with figures ("0" to "x" depending on the value) and with many values they are separated by semicolons. The EK-87 always responds with the corresponding text.

Errors on entry are treated as follows:

Error no.	Meaning
-01-	Incorrect or non-existent parameter entry
-04-	Parameter is write-protected
-05-	Calibration or user lock locked
-06-	Entered value outside permissible limits
-07-	Incorrect user combination
-11-	Transfer error

Example of reading out and setting of values:

Entry (e.g. PC keyboard)	EK-87 output	Remark
01h<CR>		Switches on VC protocol
P23<CR> or <=>		Entry of desired value (e.g. pmax)
	<STX> <LF> P23=10.000 <LF><CR><ETX>	Output of the interrogated value
L16<CR> or <=>		Entry of desired value (e.g. ser. no. p-sensor)
	<STX> <LF> L16=123456789012 <LF><CR><ETX>	Output of the interrogated value
47110815<CR>		Attempt to set value
	<STX> <LF> -05- <LF><CR><ETX>	e.g. but cal. lock is locked
P2<CR> or <=>		Entry of the desired value (e.g. substitute pressure)
	<STX> <LF> P2=3.500 <LF><CR><ETX>	Output of the interrogated value
4.500<CR>		Entry of the desired value (e.g. substitute pressure) with open user lock
	<STX> <LF> P2=4.500 <LF><CR><ETX>	
P99<CR>		Display of whether modified parameters are present (1=Param. have been changed; 0=No changed params.)
	<STX> <LF> P99=1 <LF><CR><ETX>	
1<CR>		Acceptance of changed params. (1=Accept; 0=Discard changed parameters)
	<STX> <LF> P99=0 <LF><CR><ETX>	Output: No more changed params. present
17h<CR>		Switches off VC protocol

3.15 IDOM protocol

Using the IDOM protocol, data can be automatically output via the serial interface similar to the process-data block, either once only or cyclically. The data is structured such that it can be immediately printed out on a serial printer. All data is output in the ASCII format. Each item of data is identified with a label and is terminated with "RETURN" (ASCII 13). The following data is output:

Description	Label	Value number
Actual volume, total	Va:	H5
Standard volume, total	Vr:	H6
Absolute pressure	P	L1
Absolute temperature	T	L2
Error label	@	L4

The volumes are output in complete m³ with 8 characters. Leading zeros are filled in. The output of the pressure (abs.) is made with 3 post-decimal and a maximum of 3 pre-decimal places. No leading zeros are filled in, but zeros are appended as required.

Examples: 1.030 110.008 6.000 0.050 in bar abs.

The output of the temperature occurs in °C with 2 post-decimal and 2 pre-decimal places. A negative temperature is displayed with the sign "-". No leading zeros are filled in, but zeros are appended as required.

Examples: 25.05 15.88 6.70 0.50 0.00 -3.78 -10.00 in °C

The error label is output for every error (Alarm, Warning or Info) and without the following value (status message) while ever the error is present. Once the volume corrector operates without any error (L4=0), the error label is omitted.

Overall the following structure is formed (example):

At least one error is present:	or:	No errors are present:
Va:12345678<Return>		Va:12345678<Return>
Vr:12345678<Return>		Vr:12345678<Return>
P100.008<Return>		P40.008<Return>
T-3.78<Return>		T-3.78<Return>
@<Return>		

The interface parameters are specified as follows:

Baud rate: 2400 Bd; Parity: Even; Data bits: 7; Stop bits: 1

This does not correspond to the interface parameters specified for the DS-100 function! The switchover occurs by activating the protocol (see below) with automatic reset to the DS-100 interface parameters after the transmission. This means that the DS-100 function and the value number protocol can be accessed at any time. If the point in time for transmission of the IDOM protocol has been reached and at the same time data is still being transmitted from the DS-100 function or from the value number protocol, the IDOM protocol is suppressed and also not made up later.

3.15.1 Activating / deactivating the IDOM protocol

The output of the IDOM protocol is carried out in the sub-list "IDOM protocol". The following options can be selected:

- "immediate" Immediate, once-only data output (=P56)
- "every xx minutes" Cyclic, minutes interval (=P57)
- "at xx:00 hrs." Cyclic, hours interval (=P58)

With P57 and P58 details of the time are also needed; output every "17 min" with P57 then occurs as follows, for example: 08:00, 08:17, 08:34, 08:51, **09:00**, 09:17 etc.). With P58 the figure corresponds to the time at which the IDOM protocol is to be output (e.g.: P58=12 means that the data is output each day at 12:00 hrs.).

The interface parameters are switched back immediately after the data has been output, irrespective of the above options.

 *If the output mode is to be changed, first the previously set output form must be set to "0". Otherwise no entry can be made.*

3.16 Calibration list

All values subject to calibration regulations are also saved in the calibration list. Entry here is not possible. It only serves as a check of the values against the data contained in the design data sheet and is correspondingly structured. Therefore, it is easy for the calibration official to make a simple check.

The calibration list is called by pressing the Help key and then the keys "↑" or "↓".

4 Installation

4.1 Mounting the EK-87/S

The **EK-87/S** is intended as a 1/2 19" cassette for mounting in a 19" rack (Dimensions: see Chap. B-1). It is recommended that the device is mounted in a swivel frame.

The EK-87/S must be installed outside the Ex area.

4.2 Connecting the cables

The connection of the generator and signal lines on the Ek-87/S is made via pluggable and sealable screw terminals, each of which is located in a cable housing. The power supply is fed via permanent screw terminals.

 *Any change to the wiring must only be made with the supply voltage switched off!*

 *Special attention should be paid to the **intrinsically safe** circuits. With the EK-87/S it must be ensured before switching on the power supply that the connectors for the inputs **pulse, pressure and temperature** are plugged in and secured (sealed).*

The relevant installation guidelines should be followed in routing the cables. The cables must be free of tensile stresses and should be provided with **anti-kink protection** when the EK-87/S is mounted in a swivel frame.

 *The connection of the **cable screens** is made via the earthing strips. With the temperature sensor it is essential that this is carried out at both ends. With all other cables the screens are joined at one end at the EK-87 via the earthing strips provided the length of cable is less than 50 m.*

 *The conformance to the EMC requirements for CE labelling described in Appendix A-2 can only be guaranteed when the cable screens have been properly installed.*

4.2.1 Cable connection over 50 m

With cable lengths greater than 50 m the screens should normally be connected at both ends. Suitable connections are provided at the sensors. If no separate connection is available, the screens should be joined as flat as possible on the cable gland directly at the cable entry point.

 *In addition a separate potential equalisation cable ($\geq 4.0 \text{ mm}^2$) should be laid from the EK-87 to the same potential equalisation strips to which the gas meter is also earthed in order to conform to the Ex requirements.*

4.2.2 Power supply and earthing

The EK-87/S can be operated with either of the nominal voltages 230 VAC or 24 VDC. Also, both supply voltages can be connected.

A connection between the **PA** terminal and the main potential equalisation strip is specified using a cable of at least 2.5 mm^2 cross-section. If the potential equalisation is to be realised via the **PE** terminal on the 230 V supply, the **PE** feed must also have a cross-sectional area of at least 2.5 mm^2 .

4.2.3 Pulse generator inputs

The pulse generator inputs on the EK-87/S are situated at the back of the device on the board **EXZE4**. The first sensor should be connected to the terminals **1+** and **1-**. Another, second sensor is connected to the terminals **2+** and **2-**. The terminals **3+** and **3-**, resp. **4+** and **4-** should not be connected at the present time.

The screens must be connected along the shortest path to the earthing strip using 3 mm cable lugs.

4.2.4 Pressure and temperature sensor inputs

The EK-87/S has the terminals **P+** and **P-** at the back of the board **EXAE2** for the connection of the pressure sensor and **I+**, **U+**, **U-** and **I-** for the temperature sensor.

The screens for the two sensors should be connected along the shortest path to the earth strip using 3 mm cable lugs.

4.2.5 Switching and pulse outputs

The relay output is available on the **DIA5** on the terminals **1O**, **1W** and **1S** and the transistor stages are accessible via the terminals **2+/2-** through to **5+/5-**. Pulse outputs for calibration applications can be provided through the separate outputs 4 and 5. The cable screens are connected to the earth strip using 3 mm cable lugs.

4.2.6 Serial interface

The serial interface is used for connecting the **AS-100/AS-200** Read-out Devices or a **PC**. The technical data is shown Appendix B-2a.

4.3 Layout

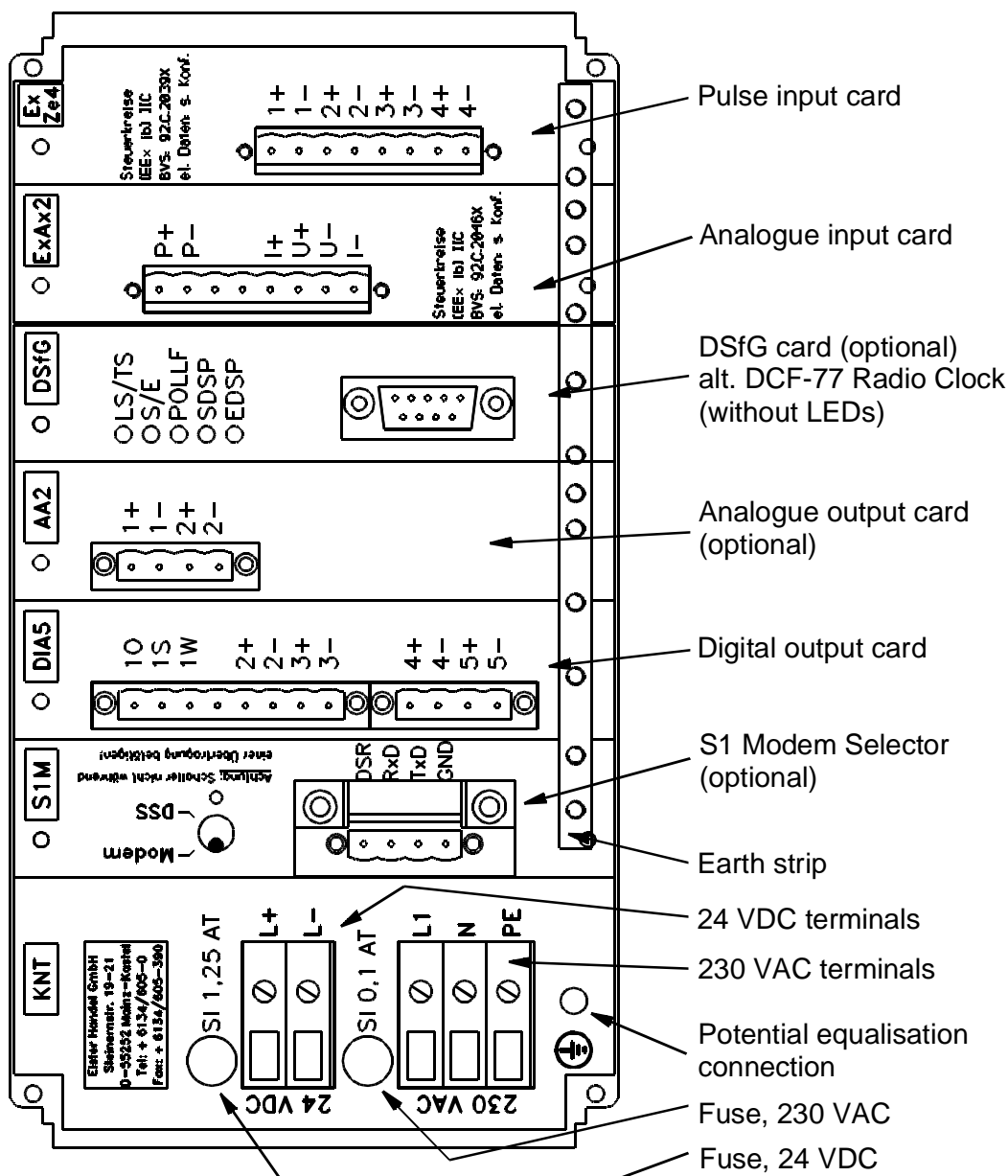

4.4 Wiring diagram

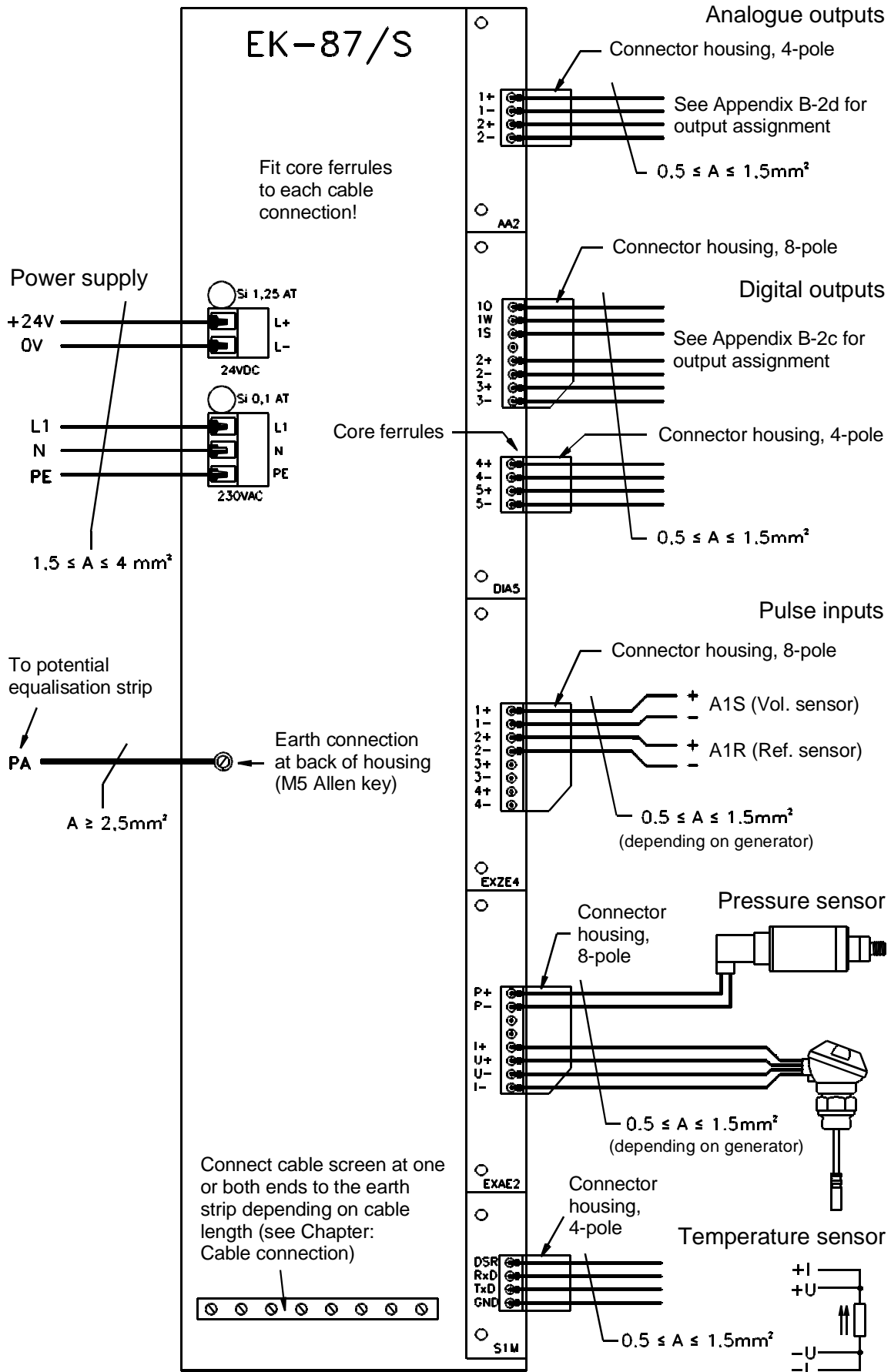

4.5 Options

4.5.1 Analogue outputs (optional)

The EK-87 can be fitted optionally with two or four analogue outputs. The channels are designated **1+/1-** through to **2+/2-** and **4+/4-**. The cable screens are connected to the earth strip using 3 mm cable lugs.

4.5.2 DSfG interface (optional)

The optional DSfG interface is available at the back of the device in the form of a 9-pole D-SUB connector. The interface connection should be secured by two knurled screws.

On the DSfG card itself there are jumpers which provide the DSfG bus with termination resistances. The techniques of obtaining the correct bus termination can be obtained from the DVGW Worksheet. As supplied ex-works, all the links are open. It should be noted that the jumpers are no longer accessible when the device is closed and sealed.

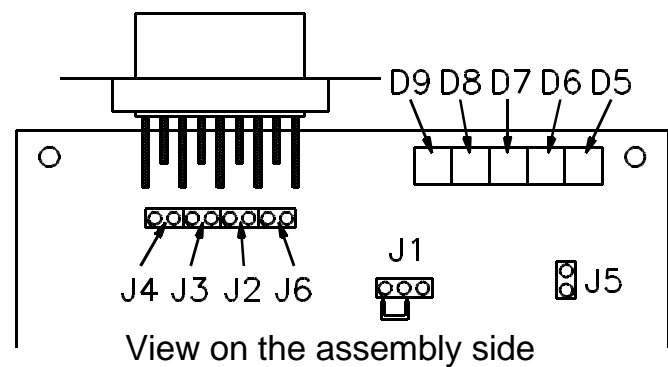

Jumper	Meaning
J1	Internal transmission speed between DSfG card and EK-87 (must remain in the indicated position)
J2	Bus termination with 120 R between RT/A and RT/B
J3/J4	Bus supply RT/A via 470 R on +U and RT/B via 470 R on SGND
J5	For future applications (do not connect)
J6	DSfG card supplies bus Pin 1 with +5V

The LEDs on the card have the following meaning:

D5	LS/TS	Control point (on) / device station (off)
D6	S/E	Send/receive. Flashing LED indicates telegram traffic
D7	POLLF	Card not addressed by bus master over a longer period
D8	SDSP	Card has Send data in memory
D9	EDSP	Card has Receive data in memory

4.5.3 DCF-77 Radio Clock (optional)

The connection of the optional DCF-77 Radio Clock receiver is made directly through the 9-pole D-SUB connector at the back of the EK-87/S. Also here, the connection should be secured with the two knurled screws.

On the plug-in card the jumpers should be inserted in the position to the right.

It should be noted that the jumpers are no longer accessible when the device is closed and sealed.

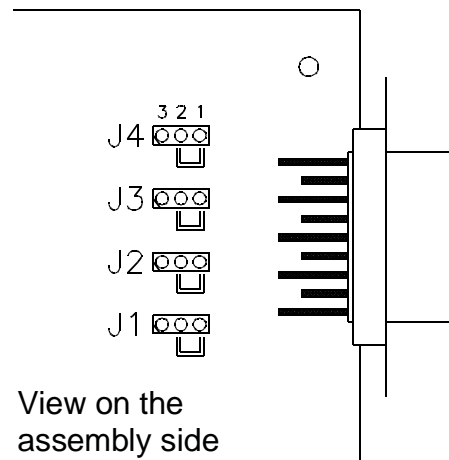

Important information on the operation of the DCF-77 Radio Clock

- The Expert mouse CLOCK should not be installed in the vicinity of electrical equipment (transformers, dimmers, motors, etc.), because these can have a significant effect on reception.
- The Expert mouse CLOCK must not be installed within metal cabinets. Also screened rooms (reinforced concrete!) represent less than ideal reception conditions. If necessary, the receiver should be led from the screened room via a suitable extension lead.
- Reception is strongly dependent on the alignment of the Expert mouse CLOCK. The best position should therefore be found manually before installation. An LED incorporated into the Expert mouse CLOCK lights green and flashes briefly in red at 1 second intervals. In this case the receiver is ready for operation.
- It is essential that the volume corrector is connected to the potential equalisation strip via the PA connection, because otherwise it can interfere with reception.
- The Expert mouse CLOCK should be fixed with a large cable cleat or adhesive tape (no metal in the vicinity of the receiver).

4.5.4 S1 Modem Connection (optional)

With the use of a modem the terminals can be optionally positioned ex-works at the back of the EK-87/S. The read-out interface at the front can be activated for service purposes via a switch.

The modem is connected to the **S1M** slot via connector screw terminals. The terminals are identified with **DSR**, **RxD**, **TxD** and **GND** and are connected 1:1 to the modem (preferably EM-100 or DK-10).

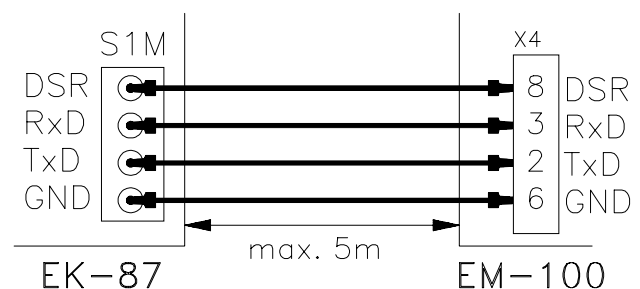

4.6 Sealing diagram

a.) Sealing on the front panel

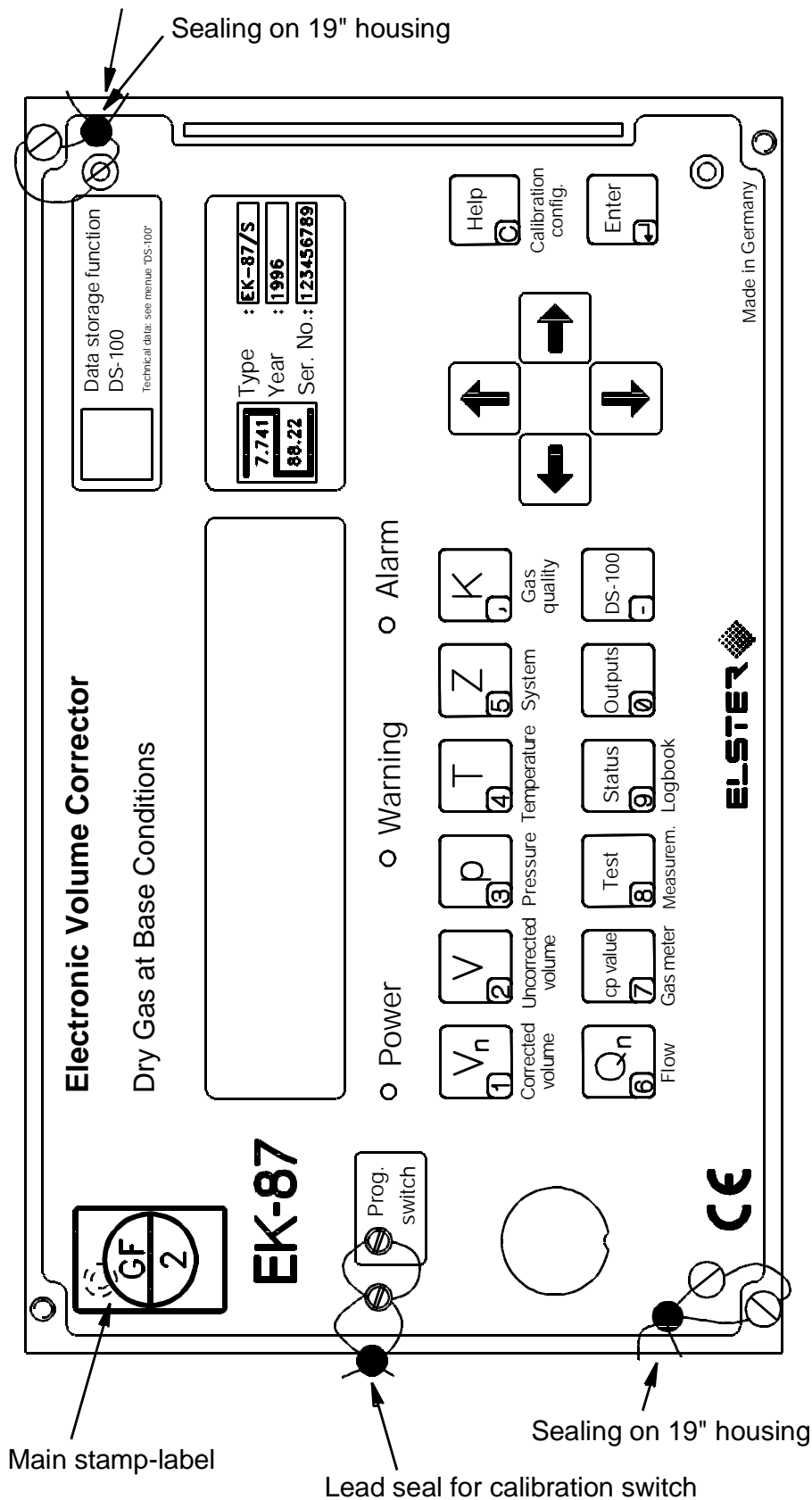

b.) Sealing at the back

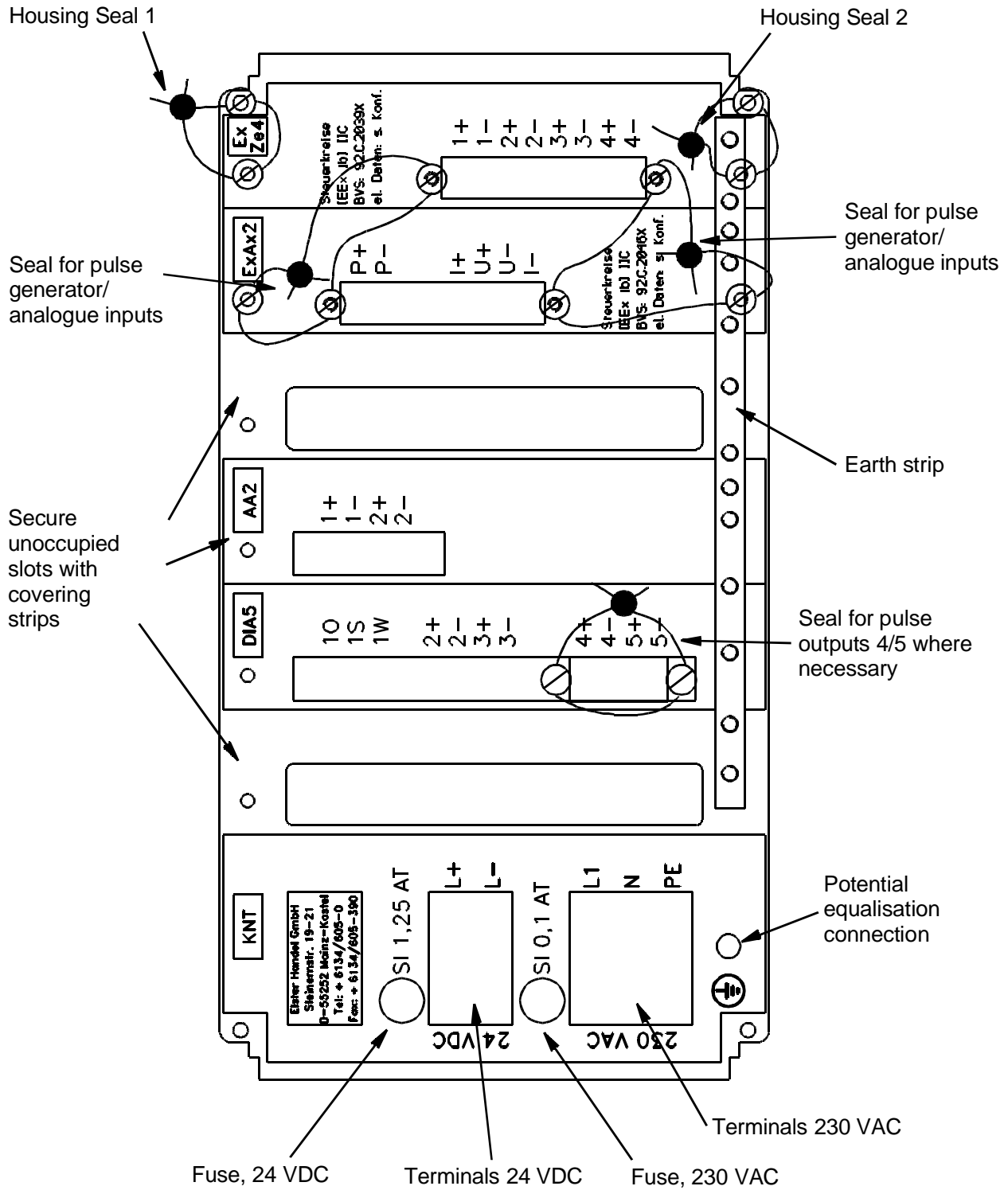

5 Check list for setting up

The following procedure in the form of a check list assumes that the device parameters have been partially set. This refers particularly to the calibration of the analogue input cards and to the calibration of the pressure and temperature inputs to suit the supplied sensors. Therefore, only the values are addressed which the operator must set. It is also assumed that the installation of the device has been carried out completely according to Section 4.

1. Check that all process signals and the mains supply are properly connected. Switch on the EK-87 and wait until the device has run up (after max. 20 seconds). The **standard undisturbed volume** V_n appears in the display and the **mains** LED lights. The **alarm** LED and the **warning** LED may light or flash.
2. **First check all parameters subject to calibration regulations and adapt them in the appropriate menus if necessary. The design data sheet can be used as an aid. This lists all the values relevant to calibration regulations. In the "Calibration List" (via the "Help" key) the values are saved in the same sequence as shown on the design data sheet. Check the parameters individually for correctness and consistency with respect to the data for the connected sensors.**

 *If changes to values subject to calibration regulations are needed, then you must first open the **calibration lock** on the front panel of the EK-87. You can refer to the tables in Chapter 3 for the description and the value range. The procedure for changing the values is described in Chapter 2.3.4.*

In the following the values are described which cannot be programmed or can only be inadequately programmed ex-works. Values subject to calibration regulations are identified with (C) and values subject to the user lock are shown with a (U):

1. The volume counters $V_n(C)$, $V_{nd}(C)$, $V(C)$, $V_d(C)$, $V_{nP}(U)$ and $V_p(U)$ can be set to any meter reading or, if necessary, reset (in the **standard volume** and **actual volume lists**); you can reset all counters in the **system list**.
2. The substitute values (U), the upper and lower limits for warning (U) with the hysteresis (U) and, where applicable, the air pressure on site (U) must be entered in the **pressure list**.
3. The substitute values (U), the upper and lower limits for warning (U) and the hysteresis (U) must be entered in the **temperature list**.

4. The date and time (C), the mode for the summer time ((C) to “no” if possible!) and the user locks (U) must be entered in the **system list**. If necessary, the pressure and/or temperature measurements can be switched off and correction carried out using fixed values only.
 - 4a. With an installed DSfG card the parameters must be set (C) in the sub-list “**DSfG settings**” (under the “System” list).
 - 4b. In the sub-list **Display setting** the mode for the background lighting ((C) “off” or “*autom. off*” if possible), the time to the return to the V_n display (C), the language (U), the units for the meter readings, pressure and temperature (C) and, where applicable, the contrast (U) must be set.
5. In the **Gas analysis list** the desired K value mode (C), the substitute K value (U) and the gas analysis values (U) must be entered.
6. The max/min. measurements for the standard and actual flow should be reset in the **Flow list** after setting up. Here, the warning limits for Q_n (U) and Q (C) and their hysteresis (U) can be entered.
7. All values relevant to the gas meter must be entered in the **Gas meter list**. This refers to the c_p values (C), the mode ((C); to “*auto*” if possible!), the max. permissible generator deviation ((C); 5% if possible), the line breakage monitoring (C), the gas meter type (C), the gas meter serial number (C), the mode for Q_{min} undercutting (C), the limits for Q_{max} (C) and Q_{min} (C/U), the flow limit for the run-up and run-down time Q_{if} (U) and the run-up and run-down times (U).
8. The assignment of the outputs and their mode must be programmed in the **Output list** (mostly under (U)). With Output 1 (relay output) particular attention should be paid to the max. output frequency. With Outputs 4 and 5 it must be defined whether they are to be secured subject to the calibration or user lock. With the pulse inputs it should be noted that with maximum flow no pulse-buffer overflow can occur (see Chap. 3.11.1). With the analogue outputs the range limits (0/4 mA - 20 mA) must be taken into account for the current output.

Apart from this, all outputs must be set to the on-site requirements; this applies to the assignment, the value which is to be output, the reference points, c_p values and max. output frequency which must be entered separately for each output!

9. When using the **DS-100 function**, the desired customer, device and meter numbers must be entered via the read-out device or laptop (see Chap. 3.12.2). Particular attention should be paid to the interval periods and the data c_p value (see Chap. 3.12.1), so that no counter overflows.

The corresponding interval and daily limits for the V and V_n channels must be entered via the AS-100. The start of the day (default: 06:00 hrs.) and, where applicable, a software combination for the protection of the set parameters (**Access recognition**) can be set via the read-out device. Here, it is essential to follow the information in Chap. 3.12.6-d.

 ***Once all parameters have been changed, it is essential to release the changes. To do this, press the “Z” key and then the cursor key “↑” once to gain access to the display “Accept parameters” or press the “↑” key twice to gain access to the display “Discard parameters”. The values are released or reset after pressing the “Enter” key.***

10. Now close the calibration switch. The user lock is also automatically closed where it is specified.
11. Then delete all faults present in the **Status list**.
12. Seal the housing and the calibration lock. The installation and configuration of the EK-87 Volume Corrector is then complete and it is ready for operation.
13. If required, you can subject the EK-87 to an operating point check. To do this, a comprehensive freeze function is available in the **Measurement list** (see Chap. 3.9.1).

6 Maintenance

The EK-87 operates largely without maintenance. Attention should be given to the recalibration periods for the pressure sensor (see separate sensor manual).

6.1 Battery replacement

During recalibration a check should be made of whether the internal back-up battery must be replaced. An **operating hours counter** and a display of the **residual capacity** in hours is provided in the EK-87 under the list "**System**". The guaranteed service life of the back-up battery is $\geq 45,000$ h.

Replacing the back-up battery

For replacement it is necessary to open the EK-87 housing. Therefore, for applications subject to calibration, a **calibration official** is essential.

 *The battery replacement can take place without mains supply. The mains voltage must be switched off for safety reasons before the housing is opened. If care is not taken in the procedure, the complete EK-87 settings may be lost (restart). The replacement should therefore only be carried out by the service personnel.*

The back-up battery on the CPU board is accessible after removing the EK-87 via the eight front-panel screws (**the cassette itself can remain in the 19" rack with the connected leads**). The connection leads to the CPU can be disconnected and the complete unit (CPU, LCD and front panel) can be removed.

The back-up battery itself is fixed to solder tags (to LP1/LP4 or LP2/LP3). The specified battery is the lithium battery from Varta type CR1/2 AA No. 6127 which can be obtained from Elster under the order no. 04270032.

The new battery is soldered in parallel to the old one (either on LP2(-)/LP3(+) or on LP1(+)/LP4(-), depending on which solder tags are free). **Please pay attention to the correct polarity.** Then the old battery can be desoldered and replacement is complete.

The front panel can now be replaced (don't forget the cable connections) and the EK-87 connected to the mains again. Under "Status" "E1 - New start" should not appear, instead only "E2 - Voltage failure" and other faults depending on circumstances. Under "System - Residual capacity display" the counter must be reset to 45,000 h (initial value) again with the calibration switch open if the above mentioned battery is used.

The replacement has now been carried out successfully.

6.2 Replacing process cards

a.) PTB approval

The replacement of the following boards **without recalibration** of the EK-87/S is approved by the PTB:

- Combi Power Supply (KNT)
- DSfG Interface Card (DSfG)
- DCF-77 Radio Clock Receiver (DCF-77)
(Expert mouse CLOCK + board)
- Pulse Input Card (ExZe4)
- Digital Output Card (DIA5)
- Analogue Output Card (AA2)

It should be noted that replacement is only permitted by the PTB **twice** within the valid calibration period. Only officially pre-tested cards, which are located in sealed boxes for transport and storage until their officially supervised installation, must be used for replacement. After replacement of these cards, the volume corrector should be subjected to a function and correctness test with the currently prevailing gas conditions. The replacement of these cards must be noted in the operational data book.

b.) Replacing cards without reprogramming

The replacement of the Output Cards (**AA2** and **DIA5**) and the Combi Power Supply (**KNT**) presents no problem. The settings and scaling of the values are not carried out in relation to the card. After replacement the EK-87 is immediately ready for operation.

c.) Replacement of cards with checking of the settings

With the replacement of the DSfG Card or the DCF-77 Radio Clock Receiver the configuration (jumpers) of the old card must be transferred. Apart from this, no settings are needed.

d.) Replacement of input cards

The replacement of the Pulse Input Card (**ExZe4**) is permitted, because also here the parameters are retained on the CPU board. Only the card number must be recorded in the operational data book.

With the replacement of the Analogue Input Card (**ExAe2**) - which however the PTB will only permit to be replaced with recalibration - only the reference points of the calibrated card must be recorded. These are noted on the enclosed test log and on the card itself. Furthermore, the card number must be recorded in the operational data book. Also here, at least one **operating point check** should be carried out (with recalibration where applicable).

7 Fault handling

7.1 Power failure

Power failure is a common fault during operation. The EK-87 has an internal back-up battery which guarantees data retention for at least 5 years. The time of the power failure and its restoration can be found in the menu "**Faults**". However, during a power failure no incoming pulses are counted.

Producing an output signal for a mains failure

If a signal is to be passed to a control station during power failure, then this is best achieved through Output 1:

"E02 - Mains failure" and **"Normally closed contact with alarm present"**.

This means that in operation Output DO1, Pins 1S and 1W are closed (see circuit diagram for the switching outputs in Appendix B-2c). The relay drops out with a mains failure and the output on Pins 1S and 1W opens. The reverse situation occurs with DO1, Pins 1O and 1W which are open in normal operation and closed during a mains failure. Therefore, a closed circuit can be opened during a mains failure (via Pins 1S/1W) or an open circuit can be closed (via Pins 1O/1W).

In principle, it is also possible to output a signal via the transistor outputs. However, the only setting that is possible here is that the circuit is closed in normal operation and opens when a fault occurs (-> normally closed function).

Reaction after power restoration

After the power has been restored, an internal check of the EK-87 takes place first and a checksum of the EPROM is formed. All outputs are set to "zero" (duration: approx. 15 seconds). In this period no volume correction can take place. Then the measurements return to their appropriate levels. Since this fault represents an alarm, the alarm LED is set (continuously lit, because the fault has "passed"). After a further 5 seconds the outputs are set to their appropriate levels and the EK-87 returns to normal operation. The mains failure can be acknowledged via "**Status**".

Precautionary measures

By employing an uninterruptible power supply (UPS) mains failures can be bridged, avoiding loss of volume. Therefore, the use of a 24 V UPS would be suitable. This must be rated for at least 15 VA (230 VAC) or 12 W (24 VDC) and is available as a special accessory from ELSTER.

7.2 First aid

The following describes the procedure for detecting faults, for checking input and output cards and how the EK-87 can be brought into normal operation again.

Fault signalling

An alarm or warning signalled by the light emitting diodes is also in the active state displayed in plain text in the Vn standard display. The fault description and possibly a remedy are listed in Chapter 3.10.

 *The complete list of all present signals (alarms, warnings and information) can only be called in the menu “**Log book**”, because various **Information** items are not indicated by LEDs nor in plain text.*

7.2.1 Checking the input and output cards

The following test checks are by no means a complete test, but will enable the customer service to draw some useful conclusions. Therefore it is essential that these checks are carried out.

7.2.1.1 Checking the Analogue Input Card (ExAe2)

a.) Fault signals E30 and E40

Check whether values can be measured in the menu “**Measurements**” under “**Analogue value, pressure**” or “**Analogue value, temperature**”.

Three question marks then appear at the appropriate point and this means that the corresponding measurement cannot be acquired.

The reason may be that the card is defective, that the cable to the sensor is broken or that the sensor itself is defective. However, this can only be established by opening the device or sensor.

b.) Fault messages “E31 - E34” or “E41 - E45”

These fault messages mean that alarm, warning or validity limits (e.g. for a K value according to AGA-NX-19 and H gas: -5...+35°C). There is also the possibility here of checking the actual measurements in the menu “**Measurements**” under “**Analogue value, pressure**” or “**Analogue value, temperature**” and then coming to a conclusion about the cause of the fault.

 With the fault messages “E31 - E34” and “E41 - E45” it is essential to check the actual measurements in the menu “**Measurements**” under “**Analogue value, pressure**”, respectively “**Analogue value, temperature**”.

If these are correct, the alarm or warning limits may be incorrectly set. You can check these in the lists for pressure and temperature and - depending on the value - change them subject to the calibration or user lock.

7.2.1.2 Checking the Pulse Input Card (ExZe4)

a.) Fault messages E10, E13, E14

These faults involve the failure of the NAMUR supply (E10) or the tripping of the cable breakage detection (E13, E14). In the list “**Measurement**” under “**Freq. Pulse Gen. 1**” or “**Freq. Pulse Gen. 2**” confirmation that the supply has failed or a cable is broken (display: “0” or “???”).

The reason here may be that the card is defective (E10), that the line to the pulse generator is interrupted or that the generator itself is defective (E13, E14). This can only be established by opening the device or examining the line. With REED contacts the cable breakage monitoring must be switched off (see Chap. 3.8).

b.) Fault message E15, E16

These fault messages signal that the two pulse generators differ from one another (e.g. fracture of a vane on the turbine-wheel meter). With correct setting of the cp values (see list: Gas meter), the maximum permissible generator deviation (if possible: 5%) should be checked (see list: Gas meter). If both are correct, there is no fault on the EK-87, but in the sensors.

c.) Fault messages E11, E12 and E20

Also here, faults are present that are mainly to be found in the system. E11 and E12 are output for input frequencies that are too high (see Chap. 3.8.1) and E20 indicates that the maximum actual flow Q_{\max} has been exceeded by over 10%. The setting of the maximum flow can be checked in the list: Gas meter. The reason may be that the flow really has been exceeded, that the pulse generator is defective or finally, that the input card is defective.

d.) Fault messages E22, E23

These messages indicate that the run-up or run-down time has been exceeded. The definition of the times is explained in Chap. 3.8.1.

The fault can also be triggered by operation below the lower flow limit Q_{ff} . In this case the system should be checked.

7.2.1.3 Checking the Digital Output Card (DIA5)

Checking the output card can be carried out without opening the device by referring to the list: “**Outputs**” for the appropriate channels. Here, it is shown in each channel which value is to be output and what the momentary output status is.

If question marks “??” are output at a point in conjunction with the message “**E05 - Card slot fault**” in the menu “**Logbook**”, the digital output card is defective. -> Service required.

With **switching contacts** (indicating alarm, warning, info or a certain fault message) the display shows whether the contact is closed (“**yes**”) or open (“**no**”). Via “**Test**” a switching output can be permanently set to a value “**yes**” or “**no**”; this can be checked using an ohmmeter. To do this, no cables should be connected to the output terminals.

With **pulse outputs** the display shows which value is output and whether pulses are in the “queue” to be output later. Here the changing display “**Output: 1/sec**” and “**Output: 0/sec**” indicates if pulses are to be output. There is also a method of test here which can give a fixed frequency on a pulse output. It should be noted though that the programmed maximum output frequency cannot be exceeded. The status can also be checked using an ohmmeter.

7.2.1.4 Checking the Analogue Output Card (AO2/AO4)

The channel in question can also be checked here in the list “**Output** “. Here is displayed in each channel which current value is to be output.

If question marks “??” are output at a point in conjunction with the message “**E05 - Card slot fault - start**” in the menu “**Log book**”, the analogue output card is defective. -> Service required.

Otherwise the current to be output can be controlled using an ammeter. Here also, no additional leads should be connected to the output terminals that are to be connected. In addition, a fixed test current between 0 and 20 mA can be output.

A Certificates

A-1 Ex approvals

DMT-Gesellschaft für Forschung und Prüfung mbH

Fachstelle für Sicherheit elektrischer Betriebsmittel
Bergbau-Versuchsstrecke

BVS



Elektrische Betriebsmittel für explosionsgefährdete Bereiche

(1) **Konformitätsbescheinigung**

(2) **BVS 92.C.2046 X**

(3) Diese Bescheinigung wird ausgestellt für:

Analogeingabe-Karte Typ EXAE2 V1.0

(4) Hergestellt und zur Bescheinigung vorgelegt von:

ELSTER Produktion GmbH
W - 6503 Mainz-Kastel

(5) Die Bauart dieses elektrischen Betriebsmittels sowie die verschiedenen zulässigen Ausführungen sind im Anhang zu dieser Konformitätsbescheinigung festgelegt.

(6) Die Bergbau-Versuchsstrecke, zugelassene Stelle entsprechend Artikel 14 der Richtlinie des Rates der Europäischen Gemeinschaften 76/117/EWG vom 18. Dezember 1975,

- bescheinigt, daß das elektrische Betriebsmittel mit den folgenden Harmonisierten Europäischen Normen übereinstimmt:

EN 50014-1977 + A1 - A5 (VDE 0170/0171 Teil 1/1.87) Allgemeine Bestimmungen
EN 50020-1977 + A1 - A2 (VDE 0170/0171 Teil 7/1.87) Eigensicherheit "i"

und mit Erfolg die nach diesen Normen vorgeschriebenen Typenprüfungen bestanden hat,

- bescheinigt, daß ein vertraulicher Prüfbericht über diese Prüfungen erstellt wurde.

(7) Das Kennzeichen des elektrischen Betriebsmittels ist:

[EEx lb] IIC

(8) Diese Bescheinigung darf nur vollständig und unverändert vervielfältigt werden.

BVS

92.C.2046 X

vom 08.09.1992



- (9) Konformitätsbescheinigung BVS 92.C.2046 X
- (10) Durch die Kennzeichnung des gelieferten Betriebsmittels bestätigt der Hersteller in eigener Verantwortung, daß dieses elektrische Betriebsmittel mit den im Anhang zu dieser Bescheinigung erwähnten darstellenden Unterlagen übereinstimmt und mit Erfolg die nach den Harmonisierten Europäischen Normen, wie sie in (6) weiter oben erwähnt sind, vorgeschriebenen Stückprüfungen bestanden hat.
- (11) Das gelieferte elektrische Betriebsmittel darf das in Anhang II der Richtlinie Nr. 84/47/EWG der Kommission vom 16. Januar 1984 dargestellte Gemeinschaftskennzeichen tragen. Dieses Kennzeichen erscheint auf der ersten Seite dieser Bescheinigung; es muß an dem elektrischen Betriebsmittel gut sichtbar, lesbar und dauerhaft angebracht sein.
- (12) Steht das Zeichen X hinter der Nummer der Konformitätsbescheinigung, so bedeutet dies, daß dieses elektrische Betriebsmittel den besonderen im Anhang zu dieser Bescheinigung aufgeführten Auflagen/Bedingungen für die sichere Anwendung unterliegt.

4600 Dortmund-Derne, den 08.09.1992
BVS-Tha/Hid A 9200243

DMT-Gesellschaft für Forschung und Prüfung mbH
Fachstelle für Sicherheit elektrischer Betriebsmittel
Bergbau-Versuchsstrecke

Dr. Dill

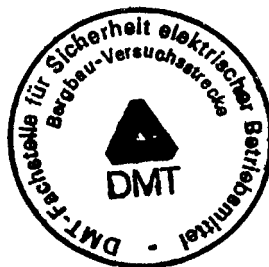



Anhang zur Konformitätsbescheinigung
BVS 92.C.2046 X

(A 1) Analogeingabe-Karte Typ EXAE2 V1.0

(A 2) Beschreibung

Die Analogeingabe-Karte Typ EXAE2 V1.0 dient zur eigensicheren Stromversorgung eines Zweidraht-Transmitters und eines Widerstandsgebers in Vierleitertechnik sowie zur Aufnahme, Umformung und Weitergabe der Signale an nichteigensichere Schaltungen.

Der zulässige Umgebungstemperaturbereich beträgt - 10 °C bis + 60 °C.

(A 3) Darstellende Unterlagen

3.1 Beschreibung (8 Bl.), unterschrieben am 10.07.92

3.2 Zeichnung Nr.:	vom:	unterschrieben am:
EXAE2V1.0/Z02 (2 Bl.)	10.02.92	10.07.92
EXAE2V1.0/Z03	10.02.92	10.07.92
EXAE2V1.0/Z04	10.02.92	10.07.92
EXAE2V1.0/Z05	10.02.92	10.07.92
EXAE2V1.0/Z06	10.02.92	10.07.92
EXAE2V1.0/Z07	10.02.92	10.07.92
EXAE2V1.0/Z08	10.02.92	10.07.92

3.3 Stückliste Nr.:	vom:	unterschrieben am:
EXAE2V1.0/Z01 (3 Bl.)	10.02.92	10.07.92



Anhang zur Konformitätsbescheinigung

BVS 92.C.2046 X

(A 4) Elektrische Daten

nichteigesichere Versorgungsspannung (Stecker ST1)	DC 24 V		
Versorgungs-/ Signalstromkreise	in Zündschutzart Eigensicherheit EEx ib IIC		
Zweidraht-Transmitter (Stecker ST3)	Höchstwerte: $U_o = 20 \text{ V}$ $I_k = 75 \text{ mA}$ lineare Kennlinie		
	höchstzul. äußere Induktivität	0,5	mH
	höchstzul. äußere Kapazität	200	nF
Widerstandsgeber (Stecker ST5/ST6)	Höchstwerte: $U_o = 9,6 \text{ V}$ $I_k = 3 \text{ mA}$ lineare Kennlinie		
	höchstzul. äußere Induktivität	10	mH
	höchstzul. äußere Kapazität	400	nF
Datenausgang (Stecker ST2)	zum Anschluß an Geräte mit einer Nennspannung bis 250 V		

Die Versorgungs-/Signalstromkreise sind von allen übrigen Stromkreisen bis zu einem Scheitelwert der Nennspannung von 375 V sicher galvanisch getrennt.



Anhang zur Konformitätsbescheinigung
BVS 92.C.2046 X

(A 5) Kennzeichnung

Die Kennzeichnung muß gut sichtbar, lesbar und dauerhaft sein; sie muß die folgenden Angaben umfassen:

5.1 Namen des Herstellers oder sein Warenzeichen

Typ EXAE2 V1.0
 [EEx ib] IIC
 Fertigungsnummer
 BVS 92.C.2046 X
 Tmin - 10 °C
 Tmax + 60 °C

5.2 Die Kennzeichnung, die normalerweise für das betreffende elektrische Betriebsmittel in den Konstruktionsnormen vorgesehen ist.

(A 6) Stückprüfungen

Die Stückprüfungen sind von der ELSTER Produktion GmbH, W - 6503 Mainz-Kastel, nach 23 von EN 50014-1977 (VDE 0170/0171 Teil 1/5.78) durchzuführen.

(A 7) Besondere Auflagen/Bedingungen für die sichere Anwendung

- 7.1 Die Analogeingabe-Karte Typ EXAE2 V1.0 ist außerhalb des explosionsgefährdeten Bereiches zu errichten.
- 7.2 Die Analogeingabe-Karte Typ EXAE2 V1.0 ist so zu errichten, daß eine Schutzart von mindestens IP 20 gemäß IEC 529 erreicht wird.

4600 Dortmund-Derne, den 08.09.1992
 BVS-Tha/Hid A 9200243

DMT-Gesellschaft für Forschung und Prüfung mbH
 Fachstelle für Sicherheit elektrischer Betriebsmittel
 Bergbau-Versuchsstrecke

Dr. Dill

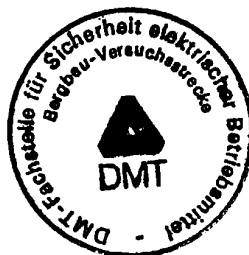

Der Sachverständige

Thater

Seite 5/5

DMT-Gesellschaft für Forschung und Prüfung mbH

Fachstelle für Sicherheit elektrischer Betriebsmittel
Bergbau-Versuchsstrecke

BVS



Elektrische Betriebsmittel für explosionsgefährdete Bereiche

(1) **Konformitätsbescheinigung**

(2) **BVS 92.C.2039 X**

(3) Diese Bescheinigung wird ausgestellt für:

Impuls-Eingangskarte Typ EXZE4

(4) Hergestellt und zur Bescheinigung vorgelegt von:

ELSTER Produktion GmbH
W - 6503 Mainz-Kastel

(5) Die Bauart dieses elektrischen Betriebsmittels sowie die verschiedenen zulässigen Ausführungen sind im Anhang zu dieser Konformitätsbescheinigung festgelegt.

(6) Die Bergbau-Versuchsstrecke, zugelassene Stelle entsprechend Artikel 14 der Richtlinie des Rates der Europäischen Gemeinschaften 76/117/EWG vom 18. Dezember 1975,

- bescheinigt, daß das elektrische Betriebsmittel mit den folgenden Harmonisierten Europäischen Normen übereinstimmt:

EN 50014-1977 + A1 - A5 (VDE 0170/0171 Teil 1/1.87) Allgemeine Bestimmungen
EN 50020-1977 + A1 - A2 (VDE 0170/0171 Teil 7/1.87) Eigensicherheit "I"

und mit Erfolg die nach diesen Normen vorgeschriebenen Typenprüfungen bestanden hat,

- bescheinigt, daß ein vertraulicher Prüfbericht über diese Prüfungen erstellt wurde.

(7) Das Kennzeichen des elektrischen Betriebsmittels ist:

[EEx Ib] IIC

(8) Diese Bescheinigung darf nur vollständig und unverändert vervielfältigt werden.

BVS

92.C.2039 X

vom

03.08.1992



- (9) Konformitätsbescheinigung BVS 92.C.2039 X
- (10) Durch die Kennzeichnung des gelieferten Betriebsmittels bestätigt der Hersteller in eigener Verantwortung, daß dieses elektrische Betriebsmittel mit den im Anhang zu dieser Bescheinigung erwähnten darstellenden Unterlagen übereinstimmt und mit Erfolg die nach den Harmonisierten Europäischen Normen, wie sie in (6) weiter oben erwähnt sind, vorgeschriebenen Stückprüfungen bestanden hat.
- (11) Das gelieferte elektrische Betriebsmittel darf das in Anhang II der Richtlinie Nr. 84/47/EWG der Kommission vom 16. Januar 1984 dargestellte Gemeinschaftskennzeichen tragen. Dieses Kennzeichen erscheint auf der ersten Seite dieser Bescheinigung; es muß an dem elektrischen Betriebsmittel gut sichtbar, lesbar und dauerhaft angebracht sein.
- (12) Steht das Zeichen X hinter der Nummer der Konformitätsbescheinigung, so bedeutet dies, daß dieses elektrische Betriebsmittel den besonderen im Anhang zu dieser Bescheinigung aufgeführten Auflagen/Bedingungen für die sichere Anwendung unterliegt.

4600 Dortmund-Derne, den 03.08.1992
BVS-Tha/Hid A 9200115

DMT-Gesellschaft für Forschung und Prüfung mbH
Fachstelle für Sicherheit elektrischer Betriebsmittel
Bergbau-Versuchsstrecke

Dr. Wenzel



Anhang zur Konformitätsbescheinigung
BVS 92.C.2039 X



(A 1) Impuls-Eingangskarte Typ EXZE4

(A 2) Beschreibung

Die Impuls-Eingangskarte Typ EXZE4 dient zur eigensicheren Stromversorgung von bis zu vier Zweidrahtsensoren und zur Aufnahme, Umformung und Weitergabe der Signale an nichteigensichere Schaltungen.

Der zulässige Umgebungstemperaturbereich beträgt - 10 °C bis + 60 °C.

(A 3) Darstellende Unterlagen

3.1 Beschreibung (6 Bl.), unterschrieben am 10.06.92

3.2 Zeichnung Nr.:	vom:	unterschrieben am:
EXZE4V1.0/Z02 (2 Bl.)	17.12.91	10.06.92
EXZE4V1.0/Z03	17.12.91	10.06.92
EXZE4V1.0/Z04	17.12.91	10.06.92
EXZE4V1.0/Z05	17.12.91	10.06.92
EXZE4V1.0/Z06	17.12.91	10.06.92
EXZE4V1.0/Z07	17.12.91	10.06.92

3.3 Stückliste Nr.:	vom:	unterschrieben am:
EXZE4V1.0/Z01 (2 Bl.)	17.12.91	10.06.92



Anhang zur Konformitätsbescheinigung

BVS 92.C.2039 X

(A 4) Elektrische Daten

nichteingesichere
Versorgungsspannung
(Stecker ST1)

DC 24 V

Versorgungs-/
Signalstromkreise
(Klemmen ST2 bis ST5)

in Zündschutzart Eigensicherheit
EEx ib IIC

Höchstwerte je Stromkreis:

$$U_o = 11,6 \text{ V}$$

$$I_k = 11,8 \text{ mA}$$

lineare Kennlinie

höchstzul. äußere
Induktivität 10 mH

höchstzul. äußere
Kapazität 300 nF

Datenausgang
(Stecker ST6)

zum Anschluß an Geräte mit einer
Nennspannung bis 250 V

Die Versorgungs-/Signalstromkreise sind von allen übrigen
Stromkreisen bis zu einem Scheitelwert der Nennspannung
von 375 V sicher galvanisch getrennt.

(A 5) Kennzeichnung

Die Kennzeichnung muß gut sichtbar, lesbar und dauerhaft
sein; sie muß die folgenden Angaben umfassen:

5.1 Namen des Herstellers oder sein Warenzeichen

Typ EXZE4
[EEx ib] IIC
Fertigungsnummer
BVS 92.C.2039 X
Tmin - 10 °C
Tmax + 60 °C

5.2 Die Kennzeichnung, die normalerweise für das betreffende elektrische Betriebsmittel in den Konstruktionsnormen vorgesehen ist.



Anhang zur Konformitätsbescheinigung
BVS 92.C.2039 X

(A 6) Stückprüfungen

Die Stückprüfungen sind von der ELSTER Produktion GmbH,
 W - 6503 Mainz-Kastel, nach 23 von EN 50014-1977
 (VDE 0170/0171 Teil 1/5.78) durchzuführen.

(A 7) Besondere Auflagen für die sichere Anwendung

- 7.1 Die Impuls-Eingangskarte Typ EXZE4 ist außerhalb des
 explosionsgefährdeten Bereiches zu errichten.
- 7.2 Die Impuls-Eingangskarte Typ EXZE4 ist so zu
 errichten, daß eine Schutzart von mindestens IP 20
 gemäß IEC 529 erreicht wird.

4600 Dortmund-Derne, den 03.08.1992
 BVS-Tha/Hid A 9200115

DMT-Gesellschaft für Forschung und Prüfung mbH
 Fachstelle für Sicherheit elektrischer Betriebsmittel
 Bergbau-Versuchsstrecke

Der Sachverständige

Dr. Wenzel

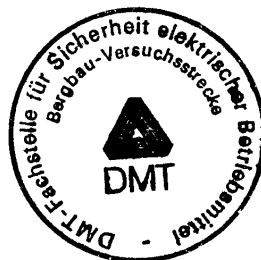

Thater

A Certificates

(Translations of German certificates)

A-1 Ex approvals

DMT-Gesellschaft für Forschung und Prüfung mbH

**Specialists for the safety of electrical equipment
Mining Test Section BVS**

Ex

Electrical equipment for areas subject to explosion hazard

- (1) **Certificate of conformance**
- (2) **BVS 92.C.2046 X**
- (3) This certificate is issued for:
Analogue Input Card Type EXAE2 V1.0
- (4) Manufactured and submitted for certification by:

Elster Produktion GmbH
W - 6503 Mainz-Kastel
- (5) The construction of this electrical equipment and the various approved versions is specified in the appendix to this conformance certificate.
- (6) The Mining Test Section, an approved station according to article 14 of the guideline from the Council of the European Community 76/117/EEG of 18th December 1975,
 - confirms that this electrical equipment meets the following Harmonised European Standards:

EN 50014-1977 + A1 - A5 (VDE 0170/0171 Part 1/1.87) General requirements
EN 50020-1977 + A1 - A2 (VDE 0170/0171 Part 7/1.87) Intrinsic Safety "i"and has successfully passed the type tests specified according to these standards,
 - confirms that a confidential test report on these tests has been produced.
- (7) The symbol for the electrical equipment is:

[Ex ib] IIC
- (8) This certificate must only be reproduced in its entirety and unmodified.

BVS 92.C.2046 X of 08.09.1992

- (9) Certificate of conformance BVS 92.C.2046 X
- (10) With the labelling of the supplied equipment the manufacturer confirms on his own responsibility that this electrical equipment conforms to the explanatory documentation mentioned in the appendix to this description and has successfully passed the routine check tests specified according the Harmonised European Standards, as mentioned above in (6).
- (11) The supplied electrical equipment may bear the Community label shown in Appendix II of Guideline No. 84/47/EWG from the Commission of 16th January 1984. This label appears on the first page of this certificate; it must be fitted to the electrical equipment so that it is easily visible, readable and permanent.
- (12) If the symbol X appears after the number of the conformance certificate, then it means that this electrical equipment is subject to the special conditions for safe application which are listed in the appendix to this certificate.

4600 Dortmund-Derne, 08.09.1992
BVS-Tha/Hid A 9200243

DMT-Gesellschaft für Forschung und Prüfung mbH
Specialists for the safety of electrical equipment
Mining Test Section

Appendix to Certificate of Conformance BVS 92.C.2046 X

(A1) Analogue Input Card Type EXAE2 V1.0

(A2) Description

The Analogue Input Card Type EXAE2 V1.0 is used for the intrinsically safe supply of power to a two-wire transmitter and a resistive transmitter in four-wire technology as well as for the acquisition, conversion and transfer of the signals to non-intrinsically safe circuits.

The permissible ambient temperature range extends from -10 °C to +60 °C.

(A3) Explanatory documentation

3.1 Description (8 pages), signed on 10.07.92

3.2 Drawing no.:	of:	signed on:
EXAE2V1.0/Z02 (2 pages)	10.02.92	10.07.92
EXAE2V1.0/Z03	10.02.92	10.07.92
EXAE2V1.0/Z04	10.02.92	10.07.92
EXAE2V1.0/Z05	10.02.92	10.07.92
EXAE2V1.0/Z06	10.02.92	10.07.92
EXAE2V1.0/Z07	10.02.92	10.07.92
EXAE2V1.0/Z08	10.02.92	10.07.92

3.3 Parts List No.:	of:	signed on:
EXAE2V1.0/Z01 (3 pages)	10.02.92	10.07.92

Appendix to Certificate of Conformance BVS 92.C.2046 X

(A4) Electrical data

Non-intrinsically safe supply voltage (connector ST1)	DC 24 V	
Supply/signal circuits	in Intrinsically Safe explosion protection EEx ib IIC	
Two-wire transmitter (connector ST3)	Maximum values: $U_0 = 20 \text{ V}$ $I_k = 75 \text{ mA}$ linear characteristic	
	max. perm. external inductance	0.5 mH
	max. perm. external capacitance	200 nF
Resistive transmitter (connector ST5/ST6)	Maximum values: $U_0 = 9.6 \text{ V}$ $I_k = 3 \text{ mA}$ linear characteristic	
	max. perm. external inductance	10 mH
	max. perm. external capacitance	400 nF
Data output (connector ST2)	For connection to equipment with a nominal voltage up to 250 V	

The supply/signal circuits are safely electrically isolated from all other circuits up to a peak nominal voltage of 375 V.

Appendix to Certificate of Conformance BVS 92.C.2046 X

(A5) Labelling

The label must be easily visible, readable and permanent; it must include the following details:

5.1 Name of the manufacturer or his trademark

Type EXAE2 V1.0

[EEx ib] IIC

Production number

BVS 92.C.2046 X

Tmin - 10 °C

Tmax + 60 °C

5.2 The label which is normally provided for the relevant electrical equipment according to the design standards.

(A6) Routine check tests

Routine check tests must be carried out by ELSTER Produktion GmbH,
W - 6503 Mainz-Kastel, according to 23 of EN 50014-1977
(VDE 0170/0171 Part 1/5.78).

(A7) Special conditions for safe use

7.1 The Analogue Input Card Type EXAE2 V1.0 should be set up
outside of the area subject to explosion hazard.

7.2 The Analogue Input Card Type EXAE2 V1.0 should be
installed such that protection to at least IP 20 according
to IEC 529 is obtained.

4600 Dortmund-Derne, 08.09.1992

BVS-Tha/Hid A 9200243

DMT-Gesellschaft für Forschung und Prüfung mbH
Specialists for the safety of electrical equipment
Mining Test Section

Responsible official

DMT-Gesellschaft für Forschung und Prüfung mbH**Specialists for the safety of electrical equipment****Mining Test Section BVS****Ex**

Electrical equipment for areas subject to explosion hazard

(1) **Certificate of conformance**

(2) **BVS 92.C.2039 X**

(3) This certificate is issued for:
Pulse Input Card Type EXZE4

(4) Manufactured and submitted for certification by:

Elster Produktion GmbH
W - 6503 Mainz-Kastel

(5) The construction of this electrical equipment and the various approved versions is specified in the appendix to this conformance certificate.

(6) The Mining Test Section, an approved station according to article 14 of the guideline from the Council of the European Community 76/117/EWG of 18th December 1975,

- confirms that this electrical equipment meets the following Harmonised European Standards:

EN 50014-1977 + A1 - A5 (VDE 0170/0171 Part 1/1.87) General requirements
EN 50020-1977 + A1 - A2 (VDE 0170/0171 Part 7/1.87) Intrinsic Safety "i"

and has successfully passed the type tests specified according to these standards,

- confirms that a confidential test report on these tests has been produced.

(7) The symbol for the electrical equipment is:

[EEx ib] IIC

(8) This certificate must only be reproduced in its entirety and unmodified.

BVS 92.C.2046 X of 03.08.1992

- (9) Certificate of conformance BVS 92.C.2039 X
- (10) With the labelling of the supplied equipment the manufacturer confirms on his own responsibility that this electrical equipment conforms to the explanatory documentation mentioned in the appendix to this description and has successfully passed the routine check tests specified according the Harmonised European Standards, as mentioned above in (6).
- (11) The supplied electrical equipment may bear the Community label shown in Appendix II of Guideline No. 84/47/EWG from the Commission of 16th January 1984. This label appears on the first page of this certificate; it must be fitted to the electrical equipment so that it is easily visible, readable and permanent.
- (12) If the symbol X appears after the number of the conformance certificate, then it means that this electrical equipment is subject to the special conditions for safe application which are listed in the appendix to this certificate.

4600 Dortmund-Derne, 03.08.1992
BVS-Tha/Hid A 9200115

DMT-Gesellschaft für Forschung und Prüfung mbH
Specialists for the safety of electrical equipment
Mining Test Section

Appendix to Certificate of Conformance

BVS 92.C.2039 X

(A1) Pulse Input Card Type EXZE4

(A2) Description

The Pulse Input Card Type EXZE4 is used for the intrinsically safe supply of power to up to four two-wire sensors and for acquisition, conversion and transfer of the signals to non- intrinsically safe circuits.

The permissible ambient temperature range extends from -10 °C to +60 °C.

(A3) Explanatory documentation

3.1 Description (6 pages), signed on 10.06.92

3.2 Drawing no.:	of:	signed on:
EXZE4V1.0/Z02 (2 pages)	17.12.91	10.06.92
EXZE4V1.0/Z03	17.12.91	10.06.92
EXZE4V1.0/Z04	17.12.91	10.06.92
EXZE4V1.0/Z05	17.12.91	10.06.92
EXZE4V1.0/Z06	17.12.91	10.06.92
EXZE4V1.0/Z07	17.12.91	10.06.92

3.3 Parts List No.:	of:	signed on:
EXZE4V1.0/Z01 (2 pages)	17.12.91	10.06.92

Appendix to Certificate of Conformance

BVS 92.C.2039 X

(A4) Electrical data

Non-intrinsically safe
supply voltage
(connector ST1)

DC 24 V

Supply/signal circuits
(Terminals ST2 to ST5)

in Intrinsically Safe explosion
protection EEx ib IIC

Maximum values per circuit:

$$U_0 = 11.6 \text{ V}$$

$$I_k = 11.8 \text{ mA}$$

linear characteristic

max. perm. external
inductance 10 mH

max. perm. external
capacitance 300 nF

Data output
(connector ST6)

For connection to equipment
with a nominal voltage up to 250 V

The supply/signal circuits are safely electrically isolated from all other circuits up to a peak nominal voltage of 375 V.

(A5) Labelling

The label must be easily visible, readable and permanent; it must include the following details:

5.1 Name of the manufacturer or his trademark

Type EXZE4

[EEx ib] IIC

Production number

BVS 92.C.2039 X

Tmin - 10 °C

Tmax + 60 °C

5.2 The label which is normally provided for the relevant electrical equipment according to the design standards.

**Appendix to Certificate of Conformance
BVS 92.C.2039 X****(A6) Routine check tests**

Routine check tests must be carried out by ELSTER Produktion GmbH,
W - 6503 Mainz-Kastel, according to 23 of EN 50014-1977
(VDE 0170/0171 Part 1/5.78).

(A7) Special conditions for safe use

- 7.1 The Pulse Input Card Type EXZE4 should be set up outside of the area subject to explosion hazard.
- 7.2 The Pulse Input Card Type EXZE4 should be installed such that protection to at least IP 20 according to IEC 529 is obtained.

4600 Dortmund-Derne, 03.08.1992
BVS-Tha/Hid A 9200115

DMT-Gesellschaft für Forschung und Prüfung mbH
Specialists for the safety of electrical equipment
Mining Test Section

Responsible official

A-2 EC Declaration of Conformance

EG-Konformitätserklärung

gemäß "Gesetz über die elektromagnetische Verträglichkeit von Geräten (EMVG)"
bzw. EMV-Richtlinie 89/336 des Rates vom 3. Mai 1989 (EMV-Richtlinie)

Der Elster Mengenumwerter

Typ EK-87/S

erfüllt die EMV-Anforderungen gemäß

DIN EN 50 082 Teil 1

sowie

DIN EN 55 022 bzw. DIN VDE 0878 Teil 3

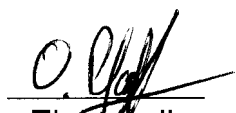
- Elektronik -
- Systeme -
O. Pfaff

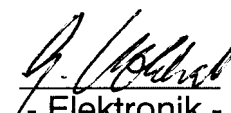
- Elektronik -
- Systeme -
G. Wohlrab

Mainz-Kastel, den 29.04.1996

ELSTER 

Elster Produktion GmbH, Steinernstraße 19, 55252 Mainz-Kastel,
Telefon: 06134/605-0; Telefax: 06134/605-390; Telex: 6 134 915

EC Declaration of Conformance

(Translation of German original)

EC Declaration of Conformance

according to the "Law on the electromagnetic compatibility of equipment (EMVG)"
and the EMC Guideline 89/336 of the Council of the 3rd May 1989 (EMC Guideline)

The Elster Volume Corrector

Type EK-87/S

fulfils the EMC requirements according to
DIN EN 50 082 Part 1
and
DIN EN 55 022 and DIN VDE 0878 Part 3

- Electronic -
- Systems -
O. Pfaff

- Electronic -
- Systems -
G. Wohlrab

Mainz-Kastel, 29th April 1996

ELSTER

Elster Produktion GmbH, Steinernstraße 19, D-55252 Mainz-Kastel,
Telephone: +49-6134-605-0; Telefax: +49-6134-605-390; Telex: 6 134 915

B Technical data

B-1 Mechanical details of EK-87/S

Housing type	1/2 19" rack cassette (42 divs, 3 ht. divs); continuously-cast aluminium, chromium plated
	Cable feed via screw/plug-in terminals
Dimensions (WxHxD)	213 x 128.5 x 228.5 mm
Weight	approx. 2.5 kg
Protection	IP 20
Ambient temperature	0.0...+40°C
Relative humidity	max. 90% without condensation

Housing dimensions (Front view)

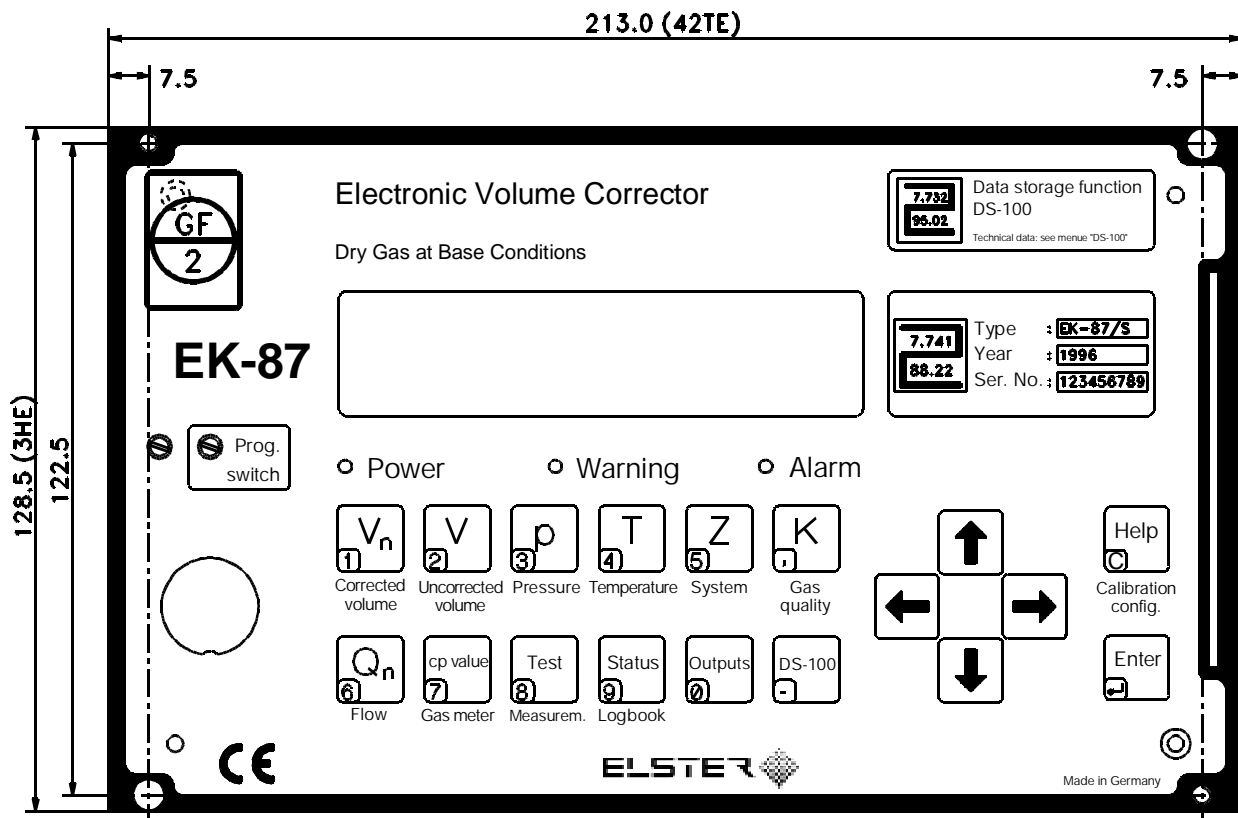

Housing dimensions (Side view)

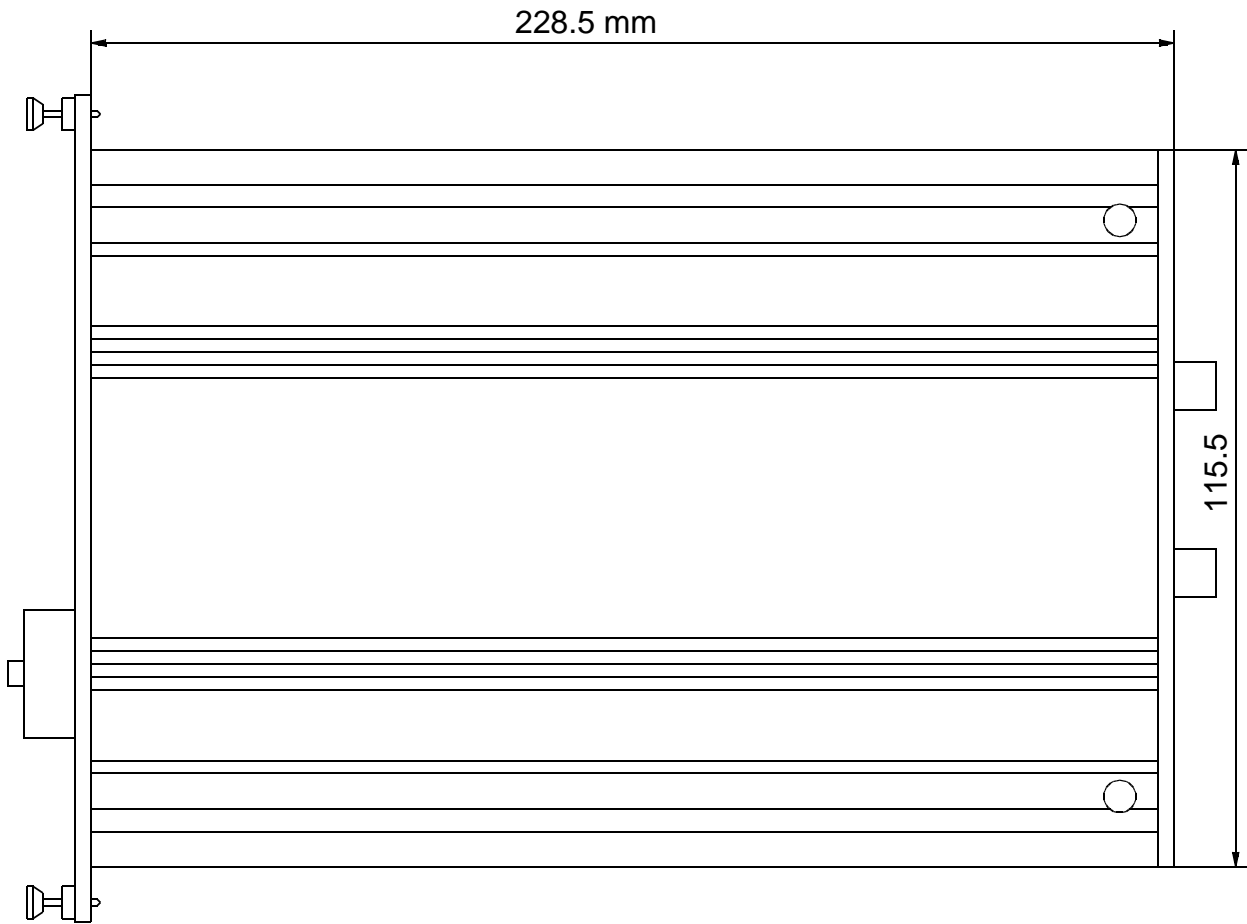

B-2 Electrical data EK-87/S

Power supply

Supply voltage	alternatively 230 VAC	or 24 VDC
	optional 110 VAC	
	Both of these supplies can be simultaneously connected!	
Voltage range	230 VAC + 8% / -20%	24 VDC \pm 20%
Power consumption	15 VA	12 W
Fuses	0.1 AT / 230 VAC	1.25 AT
	0.2 AT / 110 VAC	
Data backup	> 45000 h	> 45000 h
Terminal designation	L1; N; PE	L+; L-;
Wire thickness	1.5...4 mm ²	1.5...4mm ²
	each fitted with core sleeves.	
Potential equalisation	\geq 2.5 mm ² provided using PA terminal	

Pulse generator inputs

Designation	1+; 1-; 2+; 2-
Additional input	4+; 4-
Conformance to	NAMUR DIN 19234
Open-circuit voltage U_{nom}	8.0 V \pm 5%
Short-circuit current I_{nom}	8.0 mA \pm 5%
Switching level "on" I_{on}	2.1 mA \pm 5%
Switching level "off" I_{off}	1.2 mA \pm 5%
Hysteresis I_{hyst}	0.25 mA \pm 20%
Explosion protection	[EEx ib] IIC; BVS 92.C.2039 X
Ex-related max. values	11.6 V; 11.8 mA; 10 mH; 300 nF
Elect. isol. to EK-87	Yes, U_{min} = 2.0 kV; no isol. relative to one another
Flow rate	Q_{max} = 25000 m ³ /h
Frequency (HF1/2)	$f \leq$ 3000 Hz (A1S/A1R; cp > 10)
(LF)	$f \leq$ 10 Hz (E1; cp < 10)
Type of connection	Screw/plug-in terminals; 8-pole; green
Wire thickness	0.5...1.5 mm ² ; mandatory core sleeves
Cable length	Guaranteed: 100 m (1.5 mm ²)
Screen	mandatory; connect to one or both ends (see chapter: Cable connection)
Special features	Connection can be sealed via connector cover.

Pressure sensor input

Designation	P+; P-
Version	4-20 mA; 2-wire technology
Open-circuit volt. U_{nom}	17.5 V \pm 10%
Short-circuit current I_{nom}	Max. 24 mA
Burden	270 Ω
Measurement uncertainty over total temp. range	Max. 0.1% of measurement
Explosion protection	[EEx ib] IIC; BVS 92.C.2046 X
Ex-related max. values	20 V; 75 mA; 0.5 mH; 200 nF
Elect. isol. from EK-87	Yes, $U_{min} = 2.0$ kV; no isol. relative to one another
Type of connection	Screw/plug-in terminals; 8-pole; green
Wire thickness	0.5...1.5 mm ² ; mandatory core sleeves
Cable length	Guaranteed: 100 m (1.5 mm ²)
Screen	Mandatory; connect to one or both ends (see chapter: Cable connection)
Overall cable diam.	5.0...10.0 mm depending on sensor type.
Special features	Connection can be sealed via connector cover.

Temperature sensor input

Designation	I+; U+; U-; I-
Version	Pt100 to DIN 43760; 1/3 DIN; connection in 4-wire technology
Measurement range	-10...+60°C
Open-circuit volt. U_{nom}	Max. 8 V (+I, -I)
Short-circuit current I_{nom}	0.4 mA
Measurement uncertainty over total temp. range	Max. 0.08% of resistance value
Explosion protection	[EEx ib] IIC; BVS 92.C.2046 X
Ex-related max. values	9.6 V; 3 mA; 10 mH; 400 nF
Elect. isol. from EK-87	Yes, $U_{min} = 2.0$ kV; no isol. relative to one another
Type of connection	Screw/plug-in terminals; 8-pole; green
Wire thickness	0.5...1.5 mm ² ; mandatory core sleeves
Cable length	Guaranteed: 100 m (1.5 mm ²)
Screen	Mandatory; connect to one or both ends (see chapter: Cable connection)
Overall cable diam.	5.0...10.0 mm depending on sensor type.
Special features	Connection can be sealed via connector cover.

B-2a Serial interface (S1 interface)

Version	6-pole round socket on the front panel, conf. to RS232 and V24, short-circuit proof
Max. input voltage	$\leq 30 \text{ V}$
Input level "1"	$\geq 3 \text{ V}$
Input level "0"	$\leq 0 \text{ V}$
Baud rate	4800 baud
Number of data bits	8
Number of stop bits	1
Parity	None

Connector pin assignment

Pin 1	NC
Pin 2	TxD (Data output)
Pin 3	RxD (Data input)
Pin 4	Linked to Pin 5
Pin 5	DTR (Control input)
Pin 6	GND

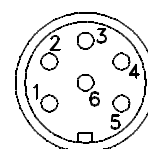

(View on the interface)

B-2b S1 Modem Connection (optional)

Order number	73015136
Version	Screw terminals at back 4 pole green; with selector for serial interface fitted at back
Wire thickness	0.5...1.5 mm ² ; mandatory core sleeves
Cable length	Guaranteed: 5 m (1.5 mm ²)
Screen	Recommended; connect to one or both ends (see chapter: Cable connection)
Overall cable diam.	approx. 5.0 mm
Special features	Connection can be sealed via connector cover
Further data	See Appendix B-2a

B-2c Digital outputs

a.) Wiring diagram of DIA5 Board

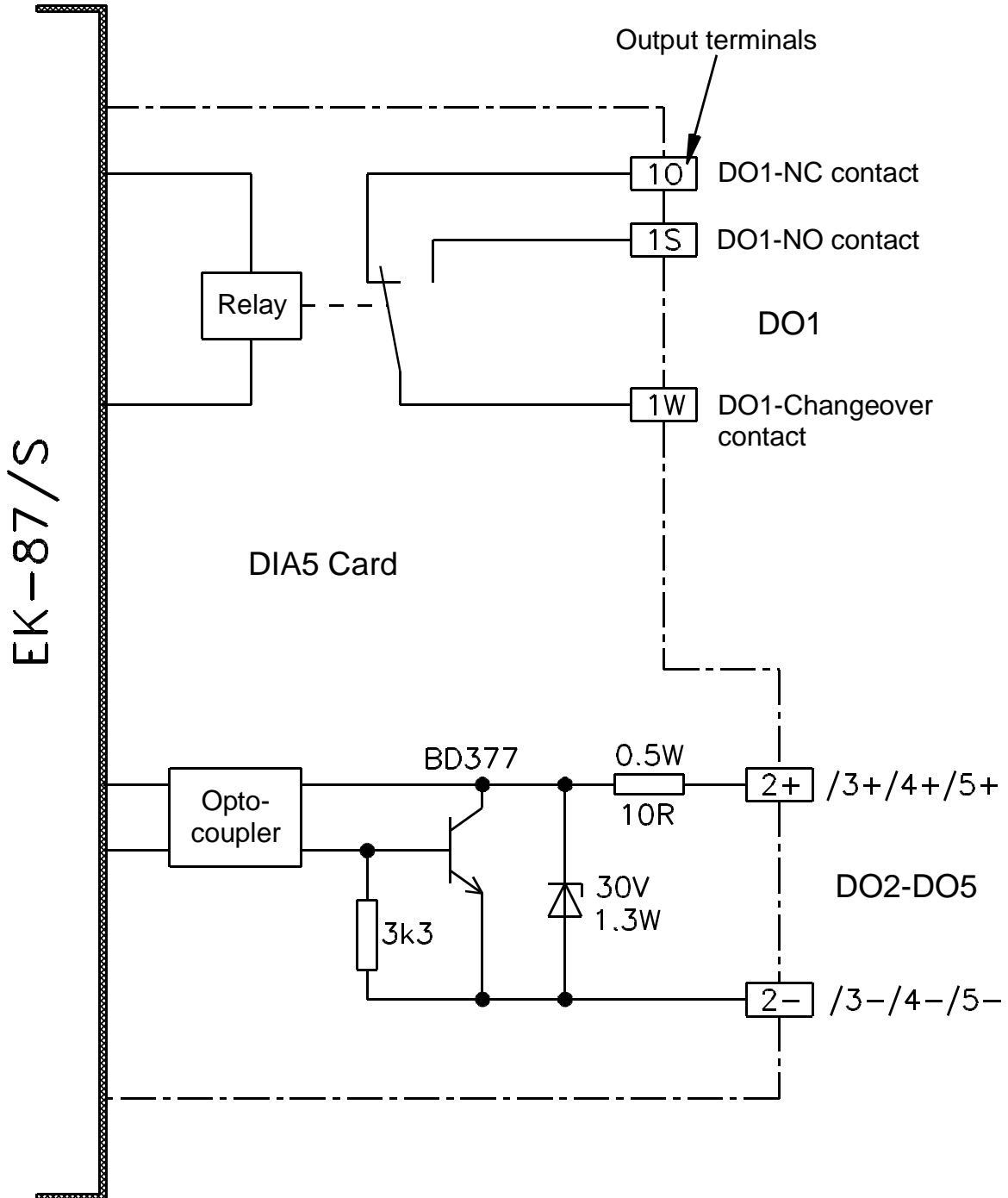

b.) Relay output parameters (DO1)

Designation	1O; 1S; 1W
Version	Relay changeover contacts
Maximum voltage	30 VAC or DC
Maximum current	100 mA AC or DC
Leakage current	0.02 mA
Maximum frequency	1.0 Hz
Electr. isol. from EK-87	Yes, $U_{\min} = 1.2$ kV
Type of connection	Screw/plug-in terminals; 8-pole; green with transistor outputs 2 and 3 (see below)
Wire thickness	0.5...1.5 mm ² ; mandatory core sleeves
Screen	Mandatory; connected at one end
Default assignment	Alarm (1S/1W)
Special features	Connection can be sealed via connector cover

c.) Transistor outputs (DO2 - DO5)

Designation	2+; 2-; 3+; 3-; 4+; 4-; 5+; 5-;
Version	Transistor outputs
Maximum voltage	28.8 VDC
Maximum current	50 mADC
Voltage drop	Max. 1.8 V at 50 mA
Leakage current	0.5 mA at 28.8 V
Maximum frequency	10 Hz
Electr. isol. from EK-87	Yes, $U_{\min} = 1.2$ kV
Electr. isol. from one another	Yes, $U_{\min} = 1.2$ kV
Type of connection	Screw/plug-in terminals; 8-pole; green Outputs 2/3 together with Rel. O/P 1 Outputs 4/5 on screw-plug terms. 4 pole green
Wire thickness	0.5...1.5 mm ² ; mandatory core sleeves
Screen	Mandatory; connected at one end
Default assignment	Vn (2+/2-); V (3+/3-); Vn (4+/4-); V (5+/5-)
Special features	DO4 and DO5 sealable subject to calibr. regs. Connection can be sealed via connector cover

B-2d Analogue outputs (optional)

a.) Wiring diagram AO2 and AO4 Board

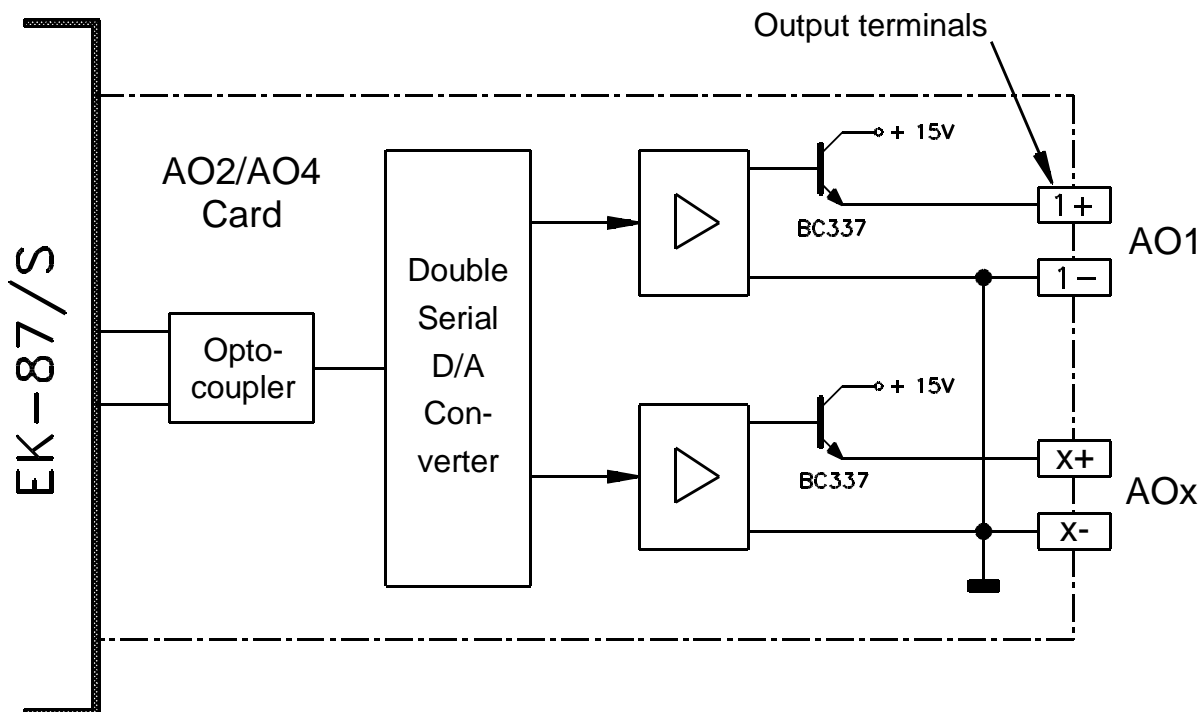

b.) AO2 and AO4 Board parameters

Order number	73015002 (2 outputs) 73015566 (4 outputs)
Designation	1+; 1-; 2+; 2- / 3+; 3-; 4+; 4-
Version	Current output 0/4...20 mA
Maximum burden	500 ohm
Max. error	0.25% of momentary current value
Electr. isol. from EK-87	Yes, $U_{\min} = 500 \text{ V}$
Electr. isol. from one another	No.
Type of connection	Screw/plug-in terminals; 4/8-pole; green
Wire thickness	0.5...1.5 mm ² ; mandatory core sleeves
Screen	Mandatory; connected at one end
Default assignment	Qn (1+/1-); Q (2+/2-); p(3+/3-); T(4+/4-)
Special features	Connection can be sealed via connector cover

B-2e DSfG interface (optional)

Order number	73015005
DSfG device	Official type "U" (corrector)
Bus address	A-Z, Ä, Ö, Ü, ^,
Baud rate	9600 or 19200
Electr. isolation to EK-87	yes, $U_{\min} = 500 \text{ V}$
Fixed parameters of Protocol Layer 2	ref. to 9600 Bd: TS = 240000 bit periods, TA = 100 msec, TB = 1100 msec, N=2, M=3, P=5
Attention telegrams	Type: I, L, W, H and P (individually selectable) Attention telegrams of type Z (time-synchr. telegr.) are accepted
Standard interrogation	1, 2 (depth 32) and 5 (depth approx. 200)
Data elements	approx. 50 single data elements from the list of DELs for correctors (see Chap. 3.5.1.4)
Cable connection	9-pole D-SUB connector
Screen	Recommended; connect at one end
Special features	Connection can be sealed via connector cover

B-2f DCF-77 Radio Clock (optional)

Order number	73015006
Receiver	Expert mouse CLOCK
Connecting cable	Length: 2.0 m, 9-pole D-SUB socket Extension 5.0 m, Order No.: 73014884 Max. cable length: 100 m
Summer-time switchover	Yes, but should not be used!
Electr. isol. from EK-87	Yes, $U_{\min} = 500 \text{ V}$
Type of connection	9-pole D-SUB connector
Screen	Recommended; connect at one end
Special features	Connection can be sealed via connector cover

B-3 Measurement uncertainty of complete unit

Actual volume (V)	No loss of pulses.
Standard volume (Vn)	< $\pm 0.4\%$ of measurement.
Pressure (p)	< $\pm 0.3\%$ of measurement.
Temperature (T)	< $\pm 0.1\%$ of measurement.
K factor (K)	< $\pm 0.01\%$ of ref. value according to GERG-88 standard.

For HF generators:

Actual flow (Q)	< $\pm 0.3\%$ of measurement.
Standard flow (Qn)	< $\pm 0.7\%$ of measurement.

For LF generators:

Actual flow (Q)	< $\pm 5\% \times f$ of measurement.
Standard flow (Qn)	< $\pm 5\% \times f \pm 0.4\%$ of measurement.

(f = input frequency in Hz; for f=0.1 Hz the error for Q is 0.5%)

C Index

Symbols

19" rack 99

A

Absolute pressure 30
 Access code 25, 90
 Acknowledgement list 63
 Actual flow, max. *See* Flow values
 Actual flow, min. *See* Flow values
 Actual volume 13
 AGA-NX-19 52
 Alarm 62, 65
 Alarm LED 17
 Alarm limit, pressure 69
 Alarm limit, temperature 70
 Alarm limits 31
 Alarm output 63
 Allocation of VC faults 87
 Analogue card, characteristic 32, 36
 Analogue input card, checking 114
 Analogue input, correction 31
 Analogue output card, checking 116
 Approval certificate 137
 Archiving cycle 42, 43
 AS-100. *See* Read-out device
 Attention telegram 40, 147

B

Back-up battery 113
 Battery replacement 111
 Battery service life 111
 Baud rate 40, 42, 43, 137
 Bus address 40, 137
 Bus master 40
 Bus termination 103

C

Cable breakage monitoring 58
 Cable screen 99
 Calibration lock 16, 25
 Calibration lock open 67
 Calibration switch 16
 Card slot fault 66
 CEST 38, 50
 CET 38, 50
 Changing values 25
 Check list for setting up 105
 Connector assignment 131
 Consumption values 80
 Contents 5
 Correction factor 13
 Counter Input 1 disturbed 67
 Counter Input 1 frequency too high 67
 Counter Input 1 suspect 68

Counter Input 2 disturbed 68
 Counter Input 2 frequency too high 67
 Counter Input 2 suspect 68
 Counter input disturbed 67
 Counter readings, resetting 38
 cp value 89
 Cursor 17

D

Data element list DSfG 44
 Data inconsistent 66
 Day boundary, setting 90
 DCF-77 38
 DCF-77 Radio Clock 50, 53
 Declaration of conformance 127
 Density ratio 52
 Design data sheet 107
 Device address 42
 Device number 89
 Digital output card 74
 Digital output card, checking 116
 Digital outputs 144
 DIN IEC 751 35
 DIN VDE 0165 8
 Direct selection function 16
 Direct selection. *See* Direct selection
 Display calibration lock 38
 Display factor 79
 Disturbance 17
 Disturbance list empty 63
 Disturbance volumes 17
 DS-100 function 79
 DSfG bus 42
 DSfG interface 44, 103, 104, 147
 DVGW 8, 40
 DVGW Work Sheet G485 44

E

E1 Generator 58
 Earthing 100
 Earthing strip 99, 100
 EG Declaration of Conformance 137
 EMC guideline 137
 Entry mode 17, 25
 Ex approvals 117
 Ex Zone 1 30, 56
 Ex Zone 2 8

F

Fault messages, calling 63
 Four-wire technology 35
 Freeze conditions 60
 Freezing the values 41
 Freezing, cyclic 61
 Freezing, immediate 60

Freezing, vol. dependent 61
Frozen set 60

G

G485 40
Gas law deviation factor. *See* K value
Gas quality 41
Generator connection 99
Generator cut-off frequency 55, 56
Generator, deviation 57

H

H gas. *See* Calorific value, high
Help 17
HF pulse generator 56
High flow recording device 79

I

IDOM protocol 97
I/O mark, setting 91
Information 62, 65
Information limit, current output 79
Installation 99
Interface. *See* Read-out interface
Interval time 80, 82, 89
Interval values 80

K

K value 13
Keypad 15, 16
Kink protection 99

L

L gas. *See* Calorific value, low
LCD display 17
LF pulse generator 56
Light emitting diodes 63, 114
Limit messages 74
Log book 53
Lower information limit Q 71
Lower information limit Qn 71
Lower warning limit pressure 69
Lower warning limit temperature 70

M

Mains failure 66, 113
Mains LED 17
Mains voltage 8
Maximum flow exceeded 68
Measurement error 147, 148
Measurement pressure 78
Measurement temperature 78
Memory fault during comparison 66
Meter number 89
Meter readings, genuine 79
Modifying connections 8
Molar content 52
Monitoring 62

N

NAMUR generators 56, 58
Normally closed contact 75
Normally open contact 75
Number block 16

O

On-line help 17
Operating hours counter 111
Operation 15
Output frequency 74
Overflow of interval counter 69
Overflow of V counter 68

P

Plug connections 99
Potential equalisation 8, 100
Potential equalisation strip 104
Power supply 100, 141
Pressure measurement disturbed 69
Pressure sensor characteristic 32, 36
Pressure sensor input 142
Process cards 112
Process data, output 93
PTB guidelines 8
Pulse buffer overflow 70
Pulse counter overflow 80
Pulse generator 56, 141
Pulse generator inputs 100
Pulse input card, checking 115
Pulse output 74
Pulse packets 76
Pulse summer 57

Q

R

Radio clock 38, 50
Read-out device 88
Recalibration 111
Relative pressure 30
Relay outputs 74, 145
Remote data transmission 93
Replacing boards 112
Replacing cards 112
Replacing input cards 112
Replacing output cards 112
Residual capacity 111
Run-down time counter violated 68
Run-up time counter violated 68

S

Safety information 8, 9
Screen 100
Sealing. *See* Sealing diagram
Standard flow, max. *See* Flow values
Standard flow, min. *See* Flow values

Standard GERG-88 V33 51
Standard pressure. *See* Standard conditions
Standard temperature. *See* Standard conditions
Substitute value 17, 62
Supplied ex-works state 99
Switching output 74
Swivel frame 99
System, new start 66

T

Temperature measurement disturbed 69
Terminals 100
Test current 77
Test function 75
Text selection 16
Time synchronisation 41
Time-synchronous output 75

U

Upper information limit Q 71
Upper information limit Qn 71
Upper warning limit, pressure 69
Upper warning limit, temperature 70
UPS 113
User lock 25
User lock, closing 48
User lock, opening 48

V

VC temperature value impermissible 70
VC temperature value warning 70
Vol. correction pressure value impermissible 69
Voltage failure 113
Voltage failure, counter input 67
Voltage re-established 113
Volume corrector fault messages 64

W

Warning 17, 62, 65
Warning LED 17
Warning limits 31
Working point check 60

Z

Z value 13