

Burner control unit PFU 780

TECHNICAL INFORMATION

- For pilot and main burners of unlimited capacity in thermoprocessing equipment pursuant to EN 746-2
- Separate flame control for pilot burner and main burner by UV, ionization or a further option of using the furnace chamber temperature
- Display of the program status, unit parameters and flame signal;
Manual mode for burner adjustment and for diagnostic purposes



Table of contents

Table of contents	2	4.5.5 Minimum operating time t_B	28
1 Application	4	4.5.6 Start-up attempts	29
1.1 Application examples	6	4.6 Behaviour during operation	31
1.1.1 Stage-controlled main burner with alternating pilot burner	6	4.6.1 Safety time during operation t_{SB} for pilot and main burners	31
1.1.2 Stage-controlled main burner with permanent pilot burner	7	4.6.2 Fault lock-out or restart, pilot burner	31
1.1.3 Control: main burner continuous	8	4.6.3 Fault lock-out or restart, main burner	33
1.1.4 PFU 780..D: high temperature equipment	9	4.7 Air valve control	35
2 Certification	10	4.7.1 Purge	35
3 Function	11	4.7.2 Cooling in start-up position/standby	35
3.1 Connection diagram	11	4.7.3 Burner start	35
3.1.1 PFU 780	11	4.7.4 Air valve opens in the case of external activation (not during start-up)	36
3.1.2 PFU 780..K2	12	4.7.5 Air valve opens in the case of external activation (even during start-up)	37
3.2 Program sequence PFU 780	13	4.7.6 Air valve opens with valve V2	38
3.3 Program status and fault messages	15	4.7.7 Air valve opens with operating signal	39
4 Parameter	16	4.7.8 Low fire over-run time t_{KN} after a controlled shut-down	40
4.1 Scanning the parameters	17	4.7.9 Behaviour of the air valve in the event of a fault lock-out	41
4.2 Flame control	17	4.8 Manual mode	42
4.2.1 Flame signal, pilot burner	17	4.8.1 Manual mode limited to 5 minutes	42
4.2.2 Flame signal, main burner	17	4.9 Password	43
4.2.3 Program status when the most recent fault occurred ..	17	5 Selection	44
4.2.4 Switch-off threshold of the flame amplifier	17	5.1 Calculating the safety time t_{SA}	44
4.2.5 High temperature operation with PFU..D	18	5.2 Selection table	44
4.2.6 UVS check	21	5.2.1 Type code	44
4.3 Pilot and main burner monitoring	22	6 Project planning information	45
4.3.1 Permanent pilot burner	23	6.1 Cable selection	45
4.3.2 Interrupted pilot burner	24	6.1.1 Ignition cable	45
4.4 Behaviour in start-up position/standby	25	6.1.2 Ionization cable	45
4.4.1 Flame simulation check in start-up position/standby ..	25	6.1.3 UV cable	45
4.4.2 Minimum burner pause time t_{BP}	26	6.2 Spark electrode	45
4.5 Behaviour during start-up	27	6.2.1 Electrode gap	45
4.5.1 Safety time on start-up t_{SA1}	27	6.2.2 Star electrodes	45
4.5.2 Safety time on start-up t_{SA2}	27	6.3 Minimum operating time	46
4.5.3 Pilot burner flame proving period t_{FS1}	27	6.4 Safety interlocks (limits)	46
4.5.4 Main burner flame proving period t_{FS2}	27		

6.5 Emergency stop	46	8.10 Fieldbus interface PFA 700	55
6.5.1 In the event of fire or electric shock	46	8.11 Impulse system MPT 700	56
6.5.2 Via the safety interlocks (limits)	46	9 Technical data	57
6.6 Reset.	47	9.1 Safety-specific characteristic values for SIL and PL.	59
6.6.1 Parallel reset	47	9.2 Operating controls.	60
6.6.2 Permanent remote reset	47	10 Maintenance cycles	61
6.6.3 Automatic remote reset (PLC)	47	11 Legend	62
6.6.4 Burner start	47	12 Glossary	63
6.6.5 Restart and start-up attempts	47	12.1 Waiting time t_W	63
6.7 Fault signal	47	12.2 Safety time on start-up t_{SA1}	63
6.8 Protecting the pilot burner from overload	48	12.3 Ignition time t_Z	63
6.9 Installation	48	12.4 Flame simulation/Flame simulation delay time t_{LV}	63
6.10 Wiring	48	12.5 Safety time during operation t_{SB}	64
6.10.1 UVS sensor wiring.	48	12.6 Flame signal.	64
6.11 PFU switched off	48	12.7 Fault lock-out	64
6.12 Furnace control	48	12.8 Safety interlocks (Limits)	64
6.13 Note on EC-type examination	48	12.9 Pilot gas valve V1	64
6.14 Mains switch	49	12.10 Main gas valve V2.	64
6.15 Changing parameters	49	12.11 Continuous operation	65
7 Flame control	50	12.12 Air valve	65
7.1 With flame rod	50	12.13 Diagnostic coverage DC.	65
7.2 With UV sensor	50	12.14 Mode of operation	65
7.3 Via the temperature in high temperature equipment	50	12.15 Safe failure fraction SFF	65
8 Accessories	51	12.16 Probability of dangerous failure PFH_D	65
8.1 High-voltage cable.	51	12.17 Mean time to dangerous failure $MTTF_d$	65
8.2 BCSofT	51	Fore more information	66
8.2.1 Opto-adapter PCO 200	51		
8.3 Stickers for labelling	51		
8.4 "Changed parameters" stickers.	51		
8.5 Radio interference suppressed terminal boots	52		
8.6 Socket connectors	52		
8.7 Module subrack	52		
8.8 Power supply PFP 700	53		
8.9 Relay module PFR 704	54		

1 Application



Burner control unit PFU 780 controls, ignites and monitors gas burners in intermittent or continuous operation. As a result of its fully electronic design, it reacts quickly to various process requirements and is therefore also suitable for frequent cycling operation.

The PFU 780 can be used for industrial burners of unlimited capacity which are ignited by pilot burners. Pilot and main burners are controlled and monitored independently. This reduces the main burner start-up time. The pilot burner can burn permanently or be switched off. The main burners may be modulating-controlled or stage-controlled.

On industrial furnaces, the PFU 780 reduces the load on the central furnace control by taking over tasks that only relate to the burner, for example it ensures that the burner always ignites in a safe condition after it has been restarted.

The burner control unit is used for burners with mechanical combustion air supply where the fan is controlled by a separate logic and for atmospheric burners.

The air valve control PFU 780L assists the furnace control for cooling, purging and capacity control tasks.

The program status, the unit parameters and the level of the flame signal can be read directly from the unit. Pilot and main burners can be controlled manually for commissioning and diagnostic purposes.

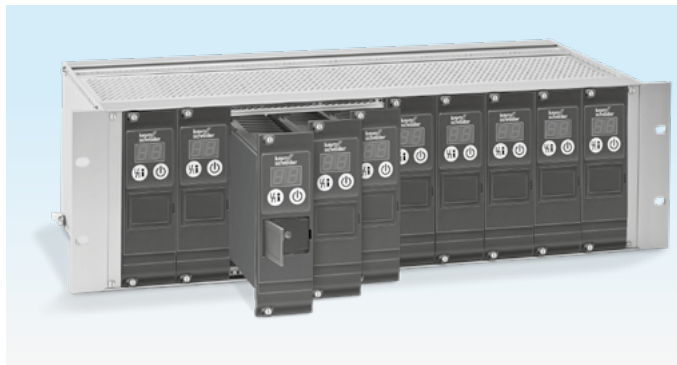

Module subrack BGT for instance serves to accommodate several function units. It is provided with a backplane with screw terminals for simple, reliable wiring.

If the local requirements on the burner control unit change, the unit parameters can be adjusted to the application via the optical interface using the PC software BCSOft.

To support service personnel, BCSOft offers a convenient visualization system of the input and output signals and the fault history.



Bogie hearth forging furnace in the metallurgical industry



Walking beam furnace with overhead firing



Intermittent shuttle kiln in the ceramics industry

1.1 Application examples

1.1.1 Stage-controlled main burner with alternating pilot burner

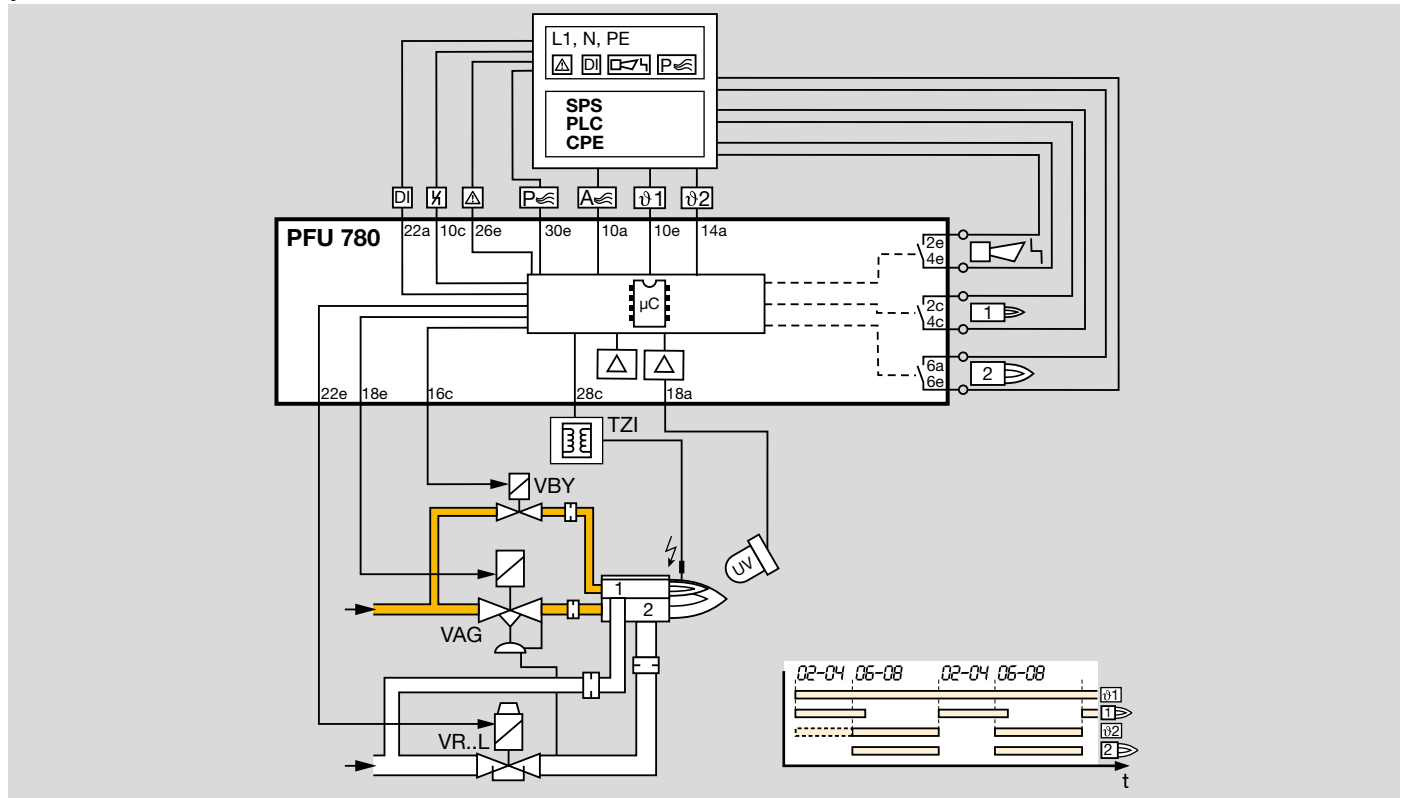

Control: main burner ON/OFF.

The main burner can be started with reduced capacity after the operating signal from the pilot burner has been detected. The pilot burner is switched off automatically af-

ter the main burner has started up. When the main burner is switched off, the pilot burner automatically switches on again. A UV sensor monitors the flame signal from pilot and main burners. UV sensor UVD 1 is used for continuous operation, UV sensor UVS for intermittent operation.

1.1.2 Stage-controlled main burner with permanent pilot burner

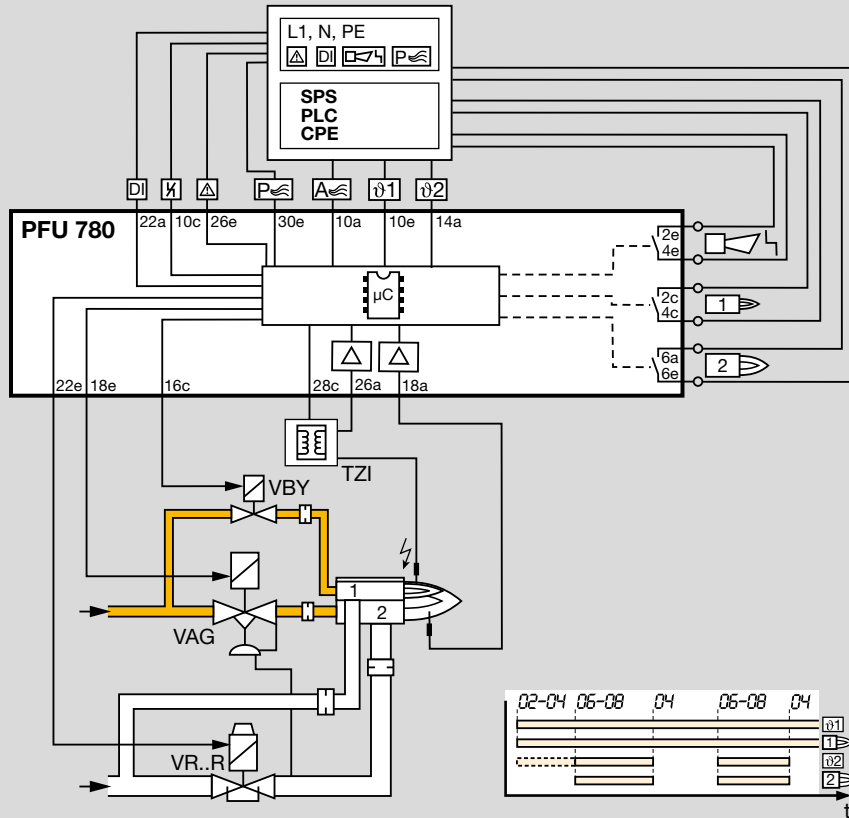

Control: main burner ON/OFF.

The main burner can be started with reduced capacity after the operating signal from the pilot burner has been detected. Pilot and main burners can be operated simultaneously. Both are ionization-controlled independently.

1.1.3 Control: main burner continuous

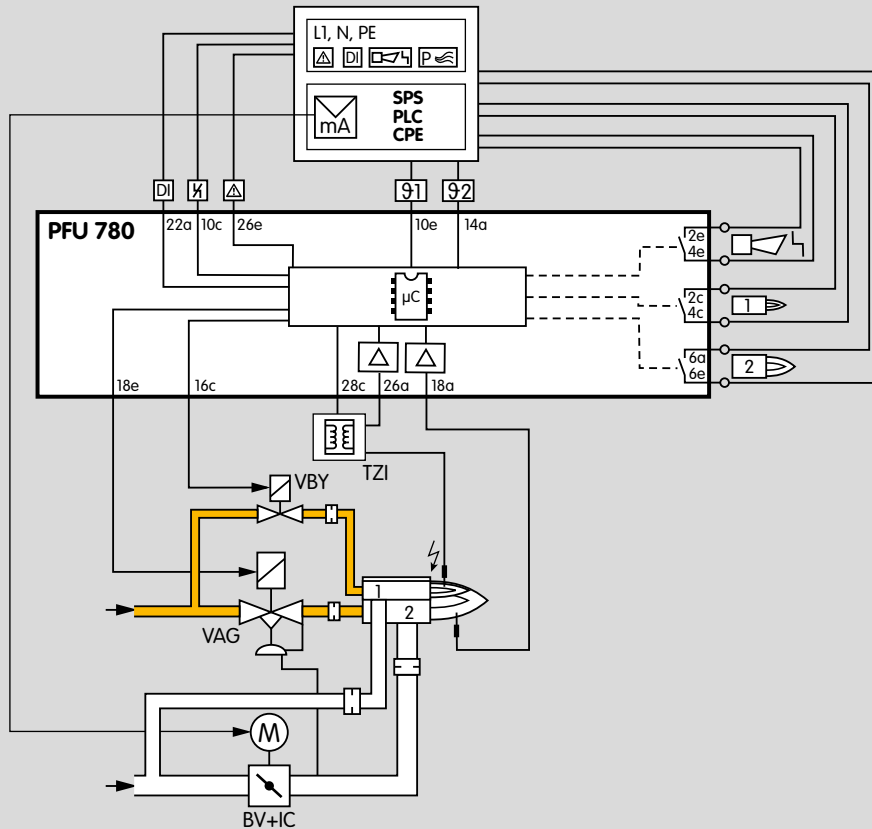

Control: main burner ON/OFF.

The butterfly valve for air BV is moved to ignition position in order to start the main burner. The main burner can be started at low-fire rate after the operating signal from the pilot burner has been detected. The control system controls the burner capacity via the butterfly valve for air BV after the

operating state has been signalled. Pilot and main burners can be operated simultaneously.

1.1.4 PFU 780..D: high temperature equipment

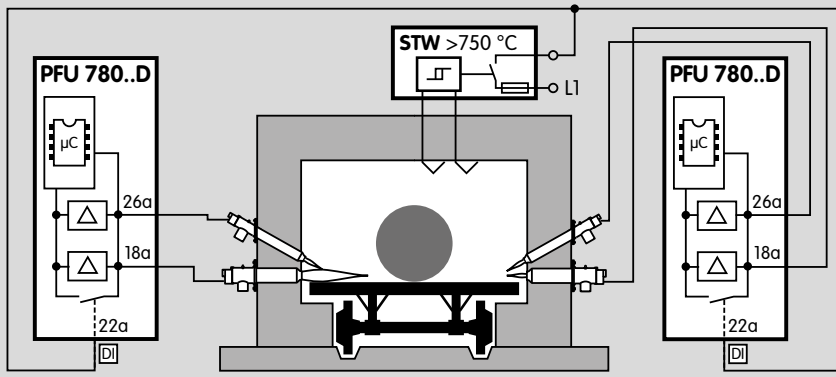

The flame is controlled indirectly on the basis of the temperature. During the start-up process, as long as the wall temperature is below auto ignition temperature, the flame must be controlled by conventional methods. When the working temperature has exceeded 750°C, the safety temperature monitor (STM) takes over the indirect flame control.

2 Certification

Certified pursuant to SIL



For systems up to SIL 3 pursuant to EN 61508

Pursuant to EN ISO 13849-1:2006, Table 4, the PFU can be used up to PL e.

EC-type tested and certified



pursuant to

- Gas Appliances Directive (2009/142/EC) in conjunction with EN 298:2004-01

Meets the requirements of the

- Low Voltage Directive (2006/95/EC)
- EMC Directive (2004/108/EC)

PFU..T is FM approved



Factory Mutual Research Class: 1997.

Suitable for applications pursuant to NFPA 86.

www.approvalguide.com

AGA approved



Australian Gas Association, Approval No.: 5597

www.aga.asn.au

3 Function

3.1 Connection diagram

Cable selection and wiring, see page 45 (Project planning information)

Explanation of symbols, see page 62 (Legend)

3.1.1 PFU 780

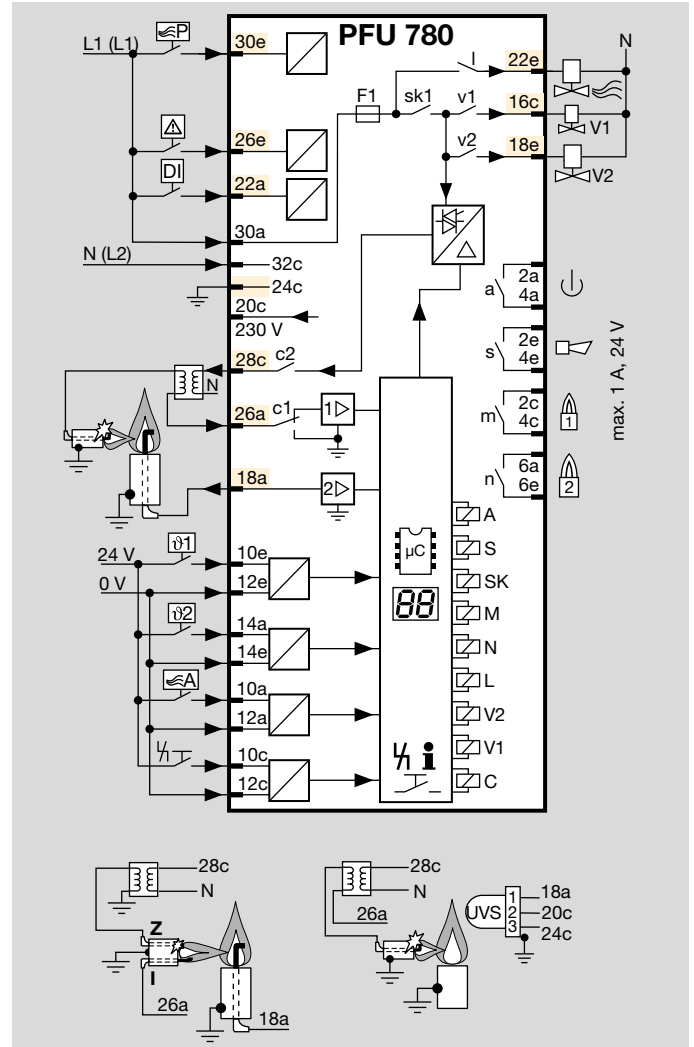

3.1.2 PFU 780..K2

As a replacement unit for burner control unit PFU 798.

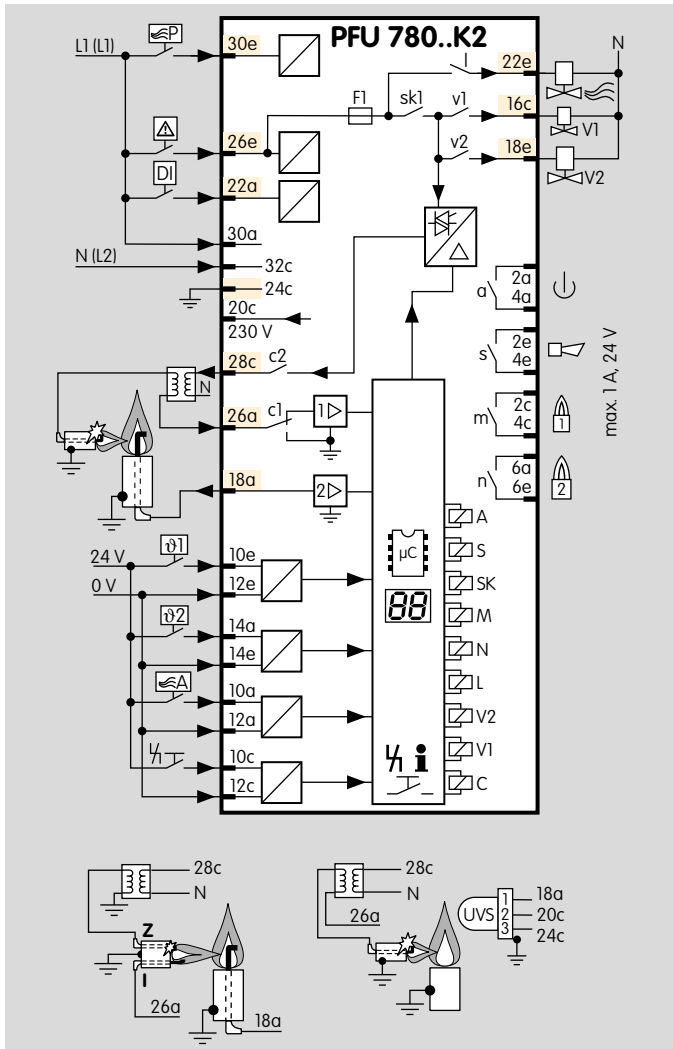

3.2 Program sequence PFU 780

Parameters 30 and 31: actuation of the air valve in standby for cooling, during start-up or during operation.

	Switch on PFU 780
	▼
	In the event of fault signal: reset
	▼
00	Safety interlocks Start-up position/Standby
	▼
00	Flame simulation check (if parameter 15 = 1)
	▼>
R0	External actuation of the air valve for cooling
	▼
01	Pilot burner start-up with ̢1 signal
	▼
01	Wait until waiting time t_{W} has elapsed
	▼
01	Flame simulation check (if parameter 15 = 0)
	▼
R1	External actuation of the air valve
	▼
02	Safety time 1 t_{SA1} (P22) running, ignition in process, valve 1 opens, min. operating time t_B starts to elapse (P20)
	▼
02	If no flame detected: next start-up attempt (P10) or fault lock-out
	▼
R2	Air valve opens with V1

	▼
03	Flame proving period 1 t_{FS1} running (P23)
	▼
03	If no flame detected: restart or fault lock-out
	▼
R3	Air valve opens with V1
	▼
04	Pilot burner operation signalling contact closes
	▼
04	If no flame detected: restart or fault lock-out
	▼
R4	Air valve opens with V1
	▼
05	Main burner start-up with ̢2 signal
	▼
05	Wait until min. burner pause time t_{BP} has elapsed (P21)
	▼
05	Flame simulation check (if parameter 15 = 0)
	▼
R5	Air valve opens with V1
	▼
06	Safety time 2 t_{SA2} (P24) running, V2 opens and min. burner on time t_B starts to elapse (P20)
	▼
06	If no flame detected: next start-up attempt (P11) or fault lock-out
	▼
R6	Air valve opens with V2

Function

	▼
07	Flame proving period 2 t_{FS2} running (P25)
	▼
07	If no flame detected: restart or fault lock-out
	▼
R7	Air valve opens with V2
	▼
08	Main burner operation signalling contact closes
	▼
08	If no flame detected: restart or fault lock-out
	▼
R8	Air valve opens with operating signal or on external activation
	▼
08	Controlled shut-down via ϑ signal for pilot and main burners
	▼
00	If min. operating time t_B has elapsed: operation signalling contact opens, V1 and V2 close, min. burner pause time t_{BP} starts to elapse (P21)

3.3 Program status and fault messages

During operation, the 7-segment display shows the program status. In the event of a fault, the PFU halts the program run, the display blinks and it then displays the cause of the fault.

The burner control unit can be reset using the Reset button or the remote reset.

Program status	DISPLAY	Fault message (blinking ¹⁾)
Start-up position/Standby	00	
Cooling	R0	
Waiting time/Pause time	1	Flame simulation
Safety time on start-up, pilot burner	2	Start-up without flame signal, pilot burner
Flame proving period, pilot burner	3	Flame failure during flame proving period, pilot burner
Operation, pilot burner	4	Flame failure during operation, pilot burner
Waiting time, main burner	5	Flame simulation, main burner
Safety time on start-up, main burner	6	Start-up without flame signal, main burner
Flame proving period, main burner	7	Flame failure during flame proving period, main burner
Operation, main burner	8	Flame failure during operation, main burner
Purge	P0	
Air valve	R	
High temperature operation ²⁾	..	
	10	Faulty remote reset
	32	Supply voltage too low
	33	Faulty parameterization
	35	Short-circuit on a valve output
	36	Short-circuit on ignition or valve output
	51	Safety interlock failure
	52	Permanent reset
	53	Time between two start-ups is too short

¹⁾ In Manual mode, two dots will blink on the display in program status 01 to 08.

²⁾ Optionally available.

4 Parameter

Description	Parameter	Value range	Factory default settings	Adjustable ¹⁾
Flame signal, pilot burner	01	0–30 μ A		
Flame signal, main burner	02	2–30 μ A		
Program status when the most recent fault occurred	03	x0–x8		
Switch-off threshold of the flame amplifier, pilot burner	04	1–20 μ A	1 μ A	•
Switch-off threshold of the flame amplifier, main burner	05	1–20 μ A	1 μ A	•
Start-up attempts, pilot burner	10	1–4	1	
Start-up attempts, main burner	11	1–4	1	
Fault lock-out or restart, pilot burner	12	0; 1	0	•
Fault lock-out or restart, main burner	13	0; 1	0	•
Safety time during operation t_{SB} for pilot and main burners	14	1; 2 s	1 s	•
Flame simulation check in start-up position/standby	15	0; 1	1	•
Permanent pilot burner	16	0; 1	1	•
Minimum operating time t_B	20	25 s	t	•
Minimum burner pause time t_{BP}	21	0–250 s	0 s	•
Safety time on start-up t_{SA1}	22	3; 5; 10 s		•
Pilot burner flame proving period t_{FS1}	23	0 – 25 s	0 s	•
Safety time on start-up t_{SA2}	24	3; 5 s		•
Main burner flame proving period t_{FS2}	25	0 – 25 s	0 s	•
Air valve control	30	0; 2; 3	0	•
Air valve can be activated externally on start-up	31	0; 1	0	•
Behaviour of the air valve in the event of a fault lock-out	32	0; 1	1	•
High temperature operation with PFU..D ²⁾	33	2; 3		
Manual mode limited to 5 minutes	34	0; 1	1	•
UVS check	35	0; 1	0	•
Low fire over-run time t_{KN} after a controlled shut-down	36	0; 5; 15; 25 s	0 s	•
Purge	42	0; 1	1	•
Multi-flame control	45	0; 1	0	•
Password	50	0000–9999	1234	•

1) Adjustable using BCSof software and a PC opto-adaptor.

2) Please quote in your order.

0 = Function inactive

1= Function active

On parameterization, ensure that the program sequence started matches the application. Select the parameters so that the burner can restart as intended in all operating phases.

4.1 Scanning the parameters

During operation, the 7-segment display shows the program status, see page 15 (Program status and fault messages).

The flame signal and all following parameters of the PFU can be scanned one after the other by repeatedly pressing the Reset/Information button (for 2 s).

In the event of a fault, the PFU halts the program run, the display blinks and it then displays the cause of the fault in coded form.

4.2 Flame control

4.2.1 Flame signal, pilot burner

Parameter 01

Flame signal of the pilot burner, display in μA , measuring range: 0–30 μA .

4.2.2 Flame signal, main burner

Parameter 02

Flame signal of the main burner, display in μA , measuring range: 0–30 μA .

4.2.3 Program status when the most recent fault occurred

Parameter 03

This indicates the program status in which the last burner fault occurred (e.g. the unit indicates that a flame simulation has been detected with a blinking $\text{U}!$).

In parameter 03, it is now shown which program position the unit was in when the fault was detected (waiting time $\text{U}!$ or standby UU).

Result: a flame simulation was detected during the waiting time or standby.

4.2.4 Switch-off threshold of the flame amplifier

Parameter 04, pilot burner switch-off threshold

Parameter 05, main burner switch-off threshold

The sensitivity at which the burner control unit still detects a flame can be set between 1 and 20 μA .

Example: in the case of UV control with the UV sensor UVS, the signal of the burner to be monitored is influenced by other burners.

The set value can be incremented in parameter 04 so that only the flame of the system's "own" burner is detected.

The measured flame signal of the system's "own" burner should be at least 3 μA (empirical value) higher than the set switch-off threshold.

4.2.5 High temperature operation with PFU..D

Parameter 33

Operation of firing systems at temperatures above 750°C. The PFU features a safety-relevant DI input (Digital Input). This input supports the “High temperature operation” function. If firing systems are operated above 750°C, the system is considered to be an item of high temperature equipment (see EN 746-2). Flame control must be in operation until the furnace wall temperature has exceeded 750°C. Note the requirements of the standards!

Flame control can be dispensed with during high temperature operation to improve the system availability. This means that no incorrect flame signals, e.g. signals from a UV sensor which are interpreted as extraneous signals due to reflection of UV radiation, may lead to faults.

When the DI input is activated, the burner control unit reverts to High temperature mode. This means: the PFU operates without evaluation of the flame signal. The safety function of the device’s internal flame control system is deactivated.

In High temperature mode, the gas valves are opened without flame control.

The precondition for high temperature operation is that an external flame supervision device ensures the presence of the flame in fail-safe manner indirectly via the temperature. For this purpose, we recommend a safety temperature monitor with double thermocouple (DIN 3440). Sensor discontinuity, sensor short-circuit, failure of a component or mains failure must set the installation to a safe state.

The voltage may be applied to the DI input (terminal 22a) so as to activate High temperature mode only when the temperature at the furnace wall has exceeded 750°C. The PFU

starts the burner as usual, without monitoring the presence of the flame.

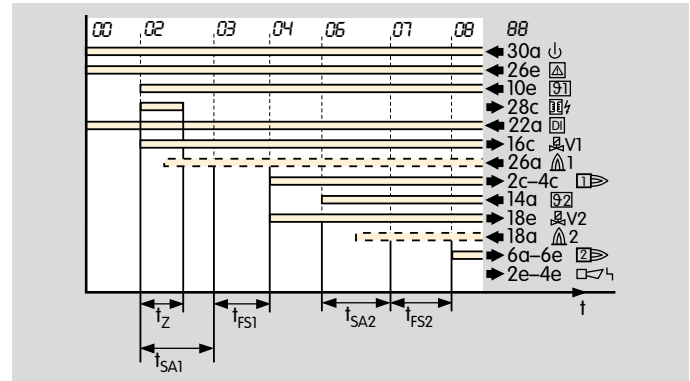

If the temperature in the furnace chamber drops below 750°C, the DI input must be disconnected from the electrical power supply and the furnace must be operated with the internal flame control system.

Parameter

The PFU then responds, depending on setting:

Parameter 33 = 1

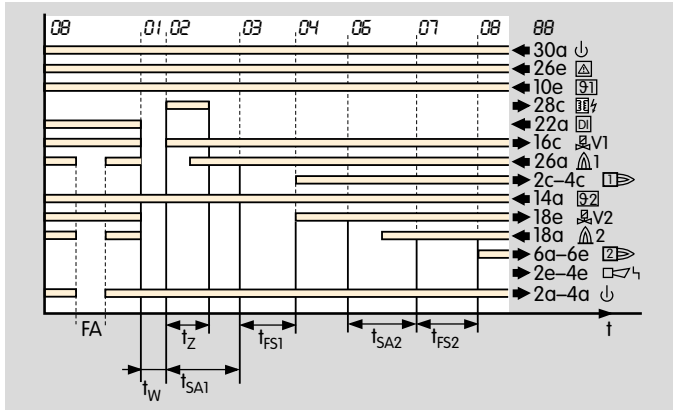

If the flame fails during high temperature operation, the ready contact opens for the duration of the flame failure (FA).

When High temperature mode is ended, the PFU switches off the burner and restarts with flame simulation check (recommended in the case of UV control with UVS).

Parameter 33 = 2

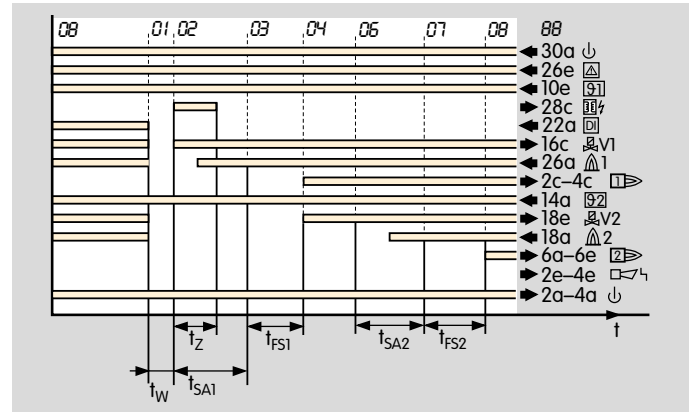

When High temperature mode is ended, the PFU switches off the burner and restarts with flame simulation check (recommended in the case of UV control with UVS).

Parameter 33 = 3

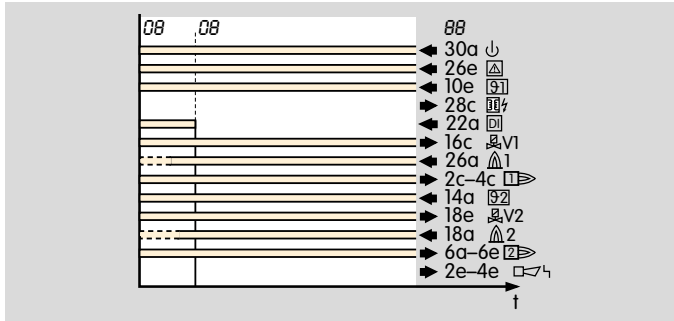

When High temperature mode is ended, the burner remains in operation and the PFU performs flame control again (recommended in the case of ionization control or UV control with UVD).

If no flame signal is present when High temperature mode is ended, the burner control unit performs a fault lock-out, regardless of parameter 33.

Fault, pilot burner

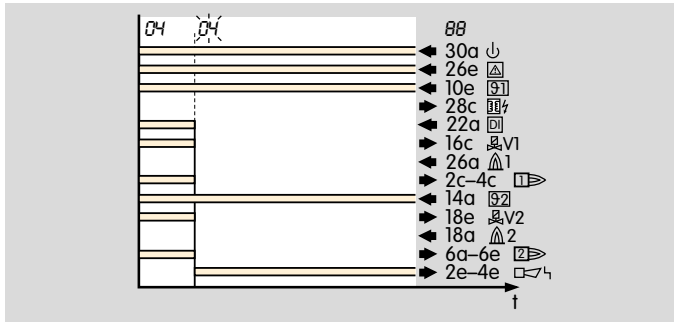

If the flame fails during high temperature operation, the ready contact is opened for the duration of the flame failure. When High temperature mode is ended, the burner remains

in operation and the PFU performs flame control again (recommended in the case of ionization control or UV control with UVD).

Fault, main burner

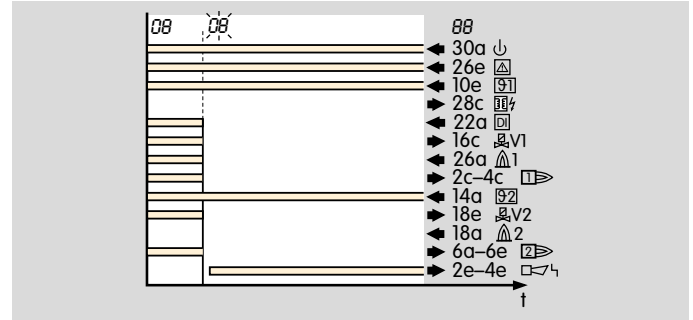

Parameter 33 = 4

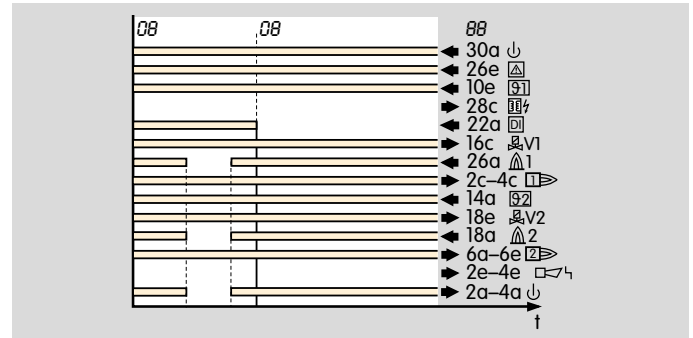

If the flame fails during high temperature operation, the ready contact is opened for the duration of the flame failure. When High temperature mode is ended, the burner remains in operation and the PFU performs flame control again (recommended in the case of ionization control or UV control with UVD).

4.2.6 UVS check

Parameter 35

An automatic restart of the burner control unit can be activated every 24 hours via this parameter. The time starts each time the start-up signal (**9**) is applied.

Parameter 35 = 0: unlimited burner operation.

Parameter 35 = 1: an automatic restart is activated once every 24 hours.

It must be ensured in this case that the program sequence started matches the application. This parameter may be set in this way only if the burner can restart as intended in all operating phases.

4.3 Pilot and main burner monitoring

Burner control unit PFU 780 for pilot and main burner combination of unlimited capacity.

Pilot burner: single-stage-controlled.

Main burner: modulating-controlled or stage-controlled.

The burner control unit PFU 780 has separate start-up signal inputs for the pilot burner (terminal 10e) and the main burner (terminal 14a). The burner control unit coordinates the program run (the interplay) of both burners. If required, the main burner can be started once the pilot burner has reached its operating position. Benefit: the time for starting up the main burner can be reduced as low as its safety time. By using two flame amplifiers, the pilot and main burners can be monitored separately.

The PFU 780 can also be used on indirectly ignited surface burners with end point monitoring.

Three different operating modes are possible:

Permanent pilot burner

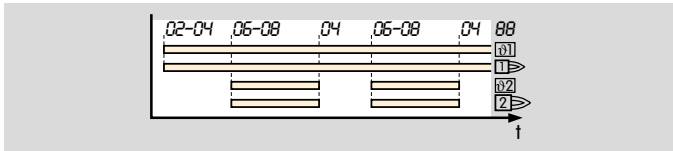

For applications which require a high system availability or where a continuously burning flame is necessary. The pilot burner is ignited once and remains constantly in operation. The main burner is controlled separately.

Intermittent pilot burner

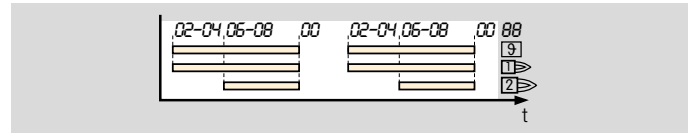

Pilot and main burners are controlled with one start-up signal (terminals 10e and 14a in parallel). The main burner starts automatically after the operating signal from the pilot burner has been detected. Operation is terminated simultaneously for both burners.

Interrupted pilot burner

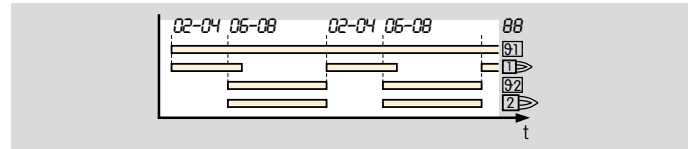

The pilot burner is switched off during the main burner safety time t_{SA2} . This type of flame control is required if no distinction can be made between the flame signals of the pilot and main burners (e.g. if both burners can be monitored with a single UV sensor). If the start-up signal for the pilot burner is applied continually, the pilot burner restarts immediately after the main burner has been switched off.

4.3.1 Permanent pilot burner

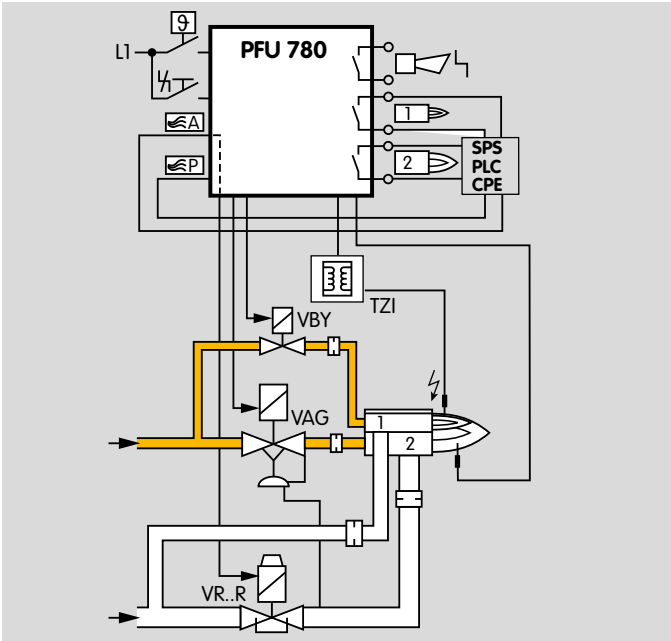
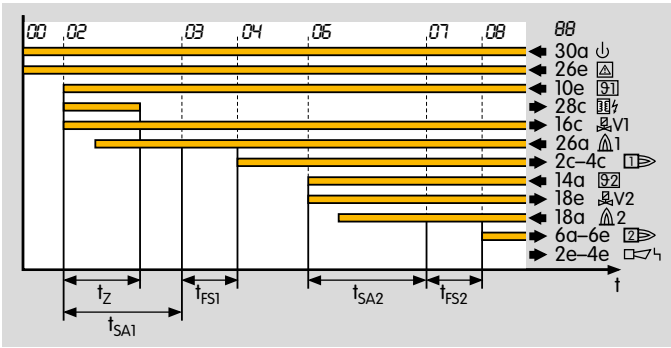

Parameter 16 = 1

Operating mode: Permanent pilot burner

In the “Permanent pilot burner” operating mode, the pilot burner remains in operation until its start-up signal drops.

If this parameter is activated ($P16 = 1$), both flames are controlled independently in the case of pilot and main burner monitoring.

Operating mode: Intermittent pilot burner

Start-up as in the illustration “Permanent pilot burner” with the difference being that the start-up signal for pilot and main burners is applied synchronously and that immediately after the flame proving period t_{FS1} , the main burner is started.

4.3.2 Interrupted pilot burner

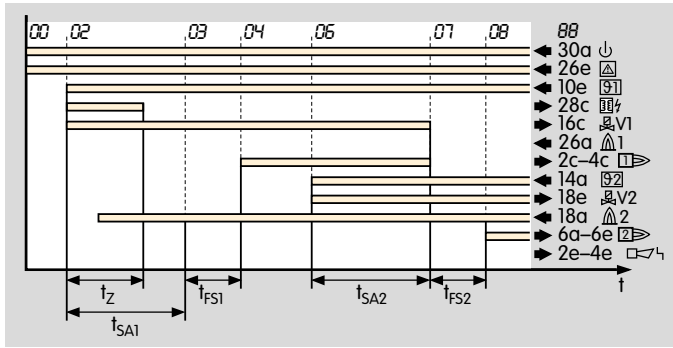

If parameter 16 = 0, the pilot burner is switched off once the safety time t_{SA2} has elapsed. In this setting, the flame signal can be connected to terminals 18a or 26a.

The pilot burner is switched off after the main burner safety time t_{SA2} has elapsed.

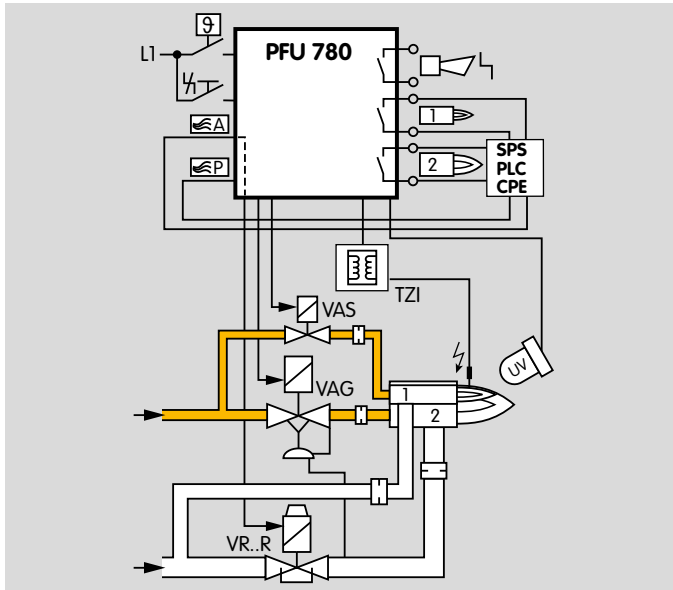

Parameter 16 = 0

Operating mode: Interrupted pilot burner

4.4 Behaviour in start-up position/standby

4.4.1 Flame simulation check in start-up position/standby

Parameter 15

This defines the instant for the flame simulation check.

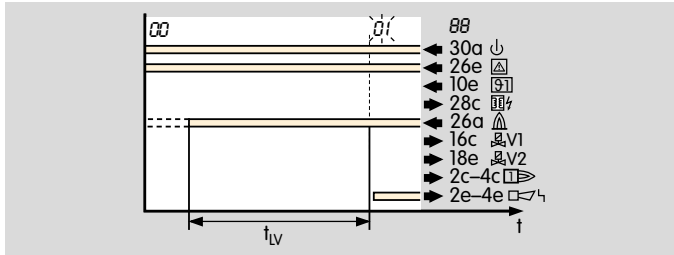

If the PFU notices an extraneous signal during the flame simulation check, it starts the flame simulation delay time t_{LV} (25 s). If the extraneous signal disappears during this time, the burner can start. Otherwise, a fault lock-out occurs. t blinks on the display if an extraneous signal is detected by the pilot burner and 5 blinks if an extraneous signal is detected by the main burner.

Parameter 15 = 0: the flame simulation check is conducted after applying the start-up signal (ϑ) during the waiting time t_{W1} .

Parameter 15 = 1: the flame simulation check is conducted provided no start-up signal (ϑ) is applied (during the so-called start-up position/standby). This allows fast start-up of the burner since there is no waiting time t_{W1} .

The burner must have been switched off for at least 4 s before start-up in order for the flame simulation check to be conducted correctly.

Flame simulation check depending on parameter 16 (Pilot burner operating mode), see page 22 (Pilot and main burner monitoring):

Parameter 15 = 1, parameter 16 = 1

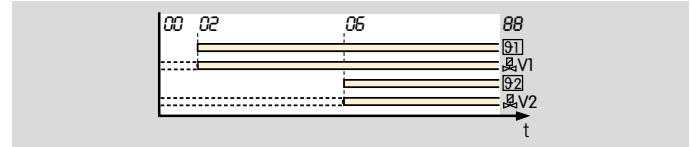

Parameter 15 = 0, parameter 16 = 1

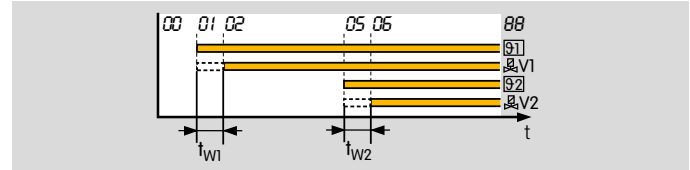

Parameter 15 = 1, parameter 16 = 0

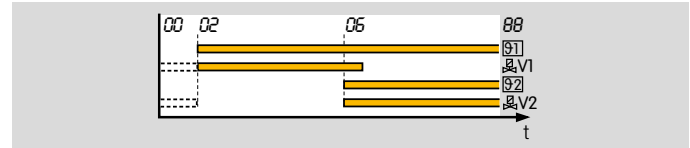

Parameter 15 = 0, parameter 16 = 0

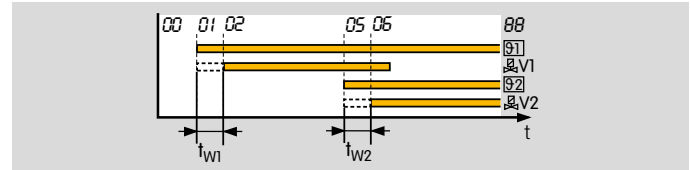

4.4.2 Minimum burner pause time t_{BP}

Parameter 21

Programmable time between 0 and 250 s.

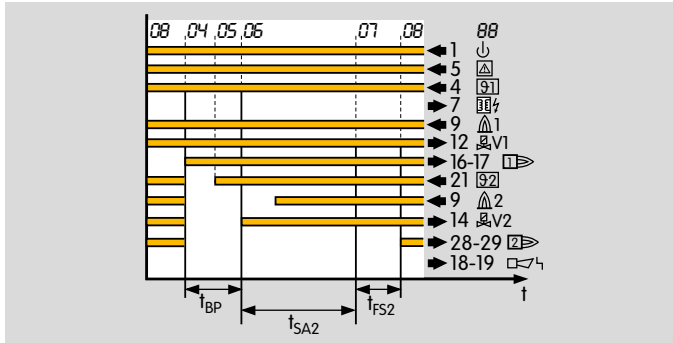

The pause time has an effect on the behaviour of the main burner only. Reason: the pilot burner is only used in single-stage operation.

An immediate restart of the main burner after a controlled shut-down, a start-up attempt, restart, cooling or purging is prevented by the pause time. The pause time starts when the air valve is switched off. If a start-up signal (2) is applied before expiry of this time, start-up is delayed until the end of the pause time.

After the pause time, the burner is started if the start-up signal (2) is applied.

The minimum burner pause time t_{BP} serves to adapt the program sequence to the requirements of the application.

The time should be set such that the system can be moved to ignition position, i.e. butterfly valves can be closed and, possibly, gas can be flared off, before a restart occurs.

See application examples on page 6 (Stage-controlled main burner with alternating pilot burner) and page 7 (Stage-controlled main burner with permanent pilot burner).

4.5 Behaviour during start-up

4.5.1 Safety time on start-up t_{SA1}

Pilot burner

Parameter 22

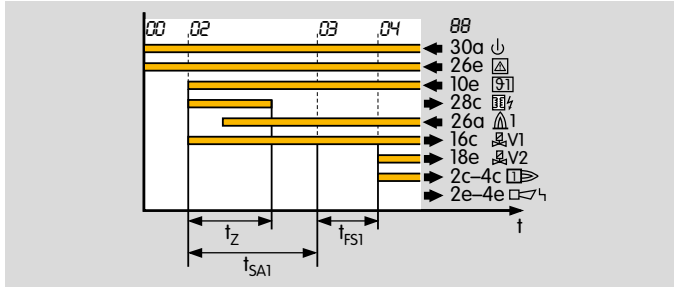

Safety time on start-up t_{SA1} for the pilot burner.

4.5.2 Safety time on start-up t_{SA2}

Main burner

Parameter 24

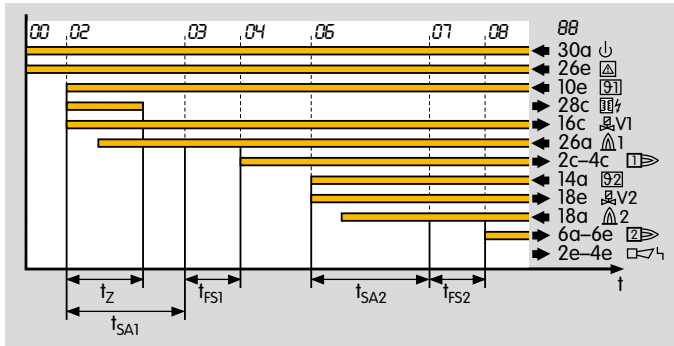

Safety time on start-up t_{SA2} for the main burner.

4.5.3 Pilot burner flame proving period t_{FS1}

Parameter 23

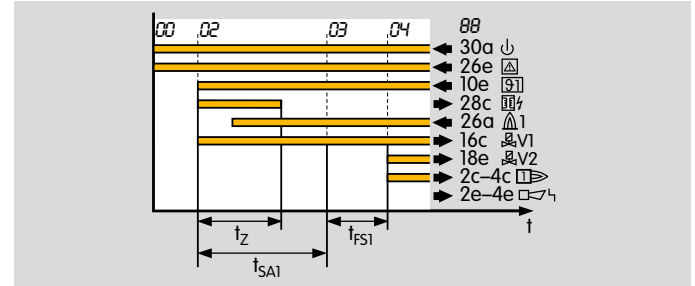

4.5.4 Main burner flame proving period t_{FS2}

Parameter 25

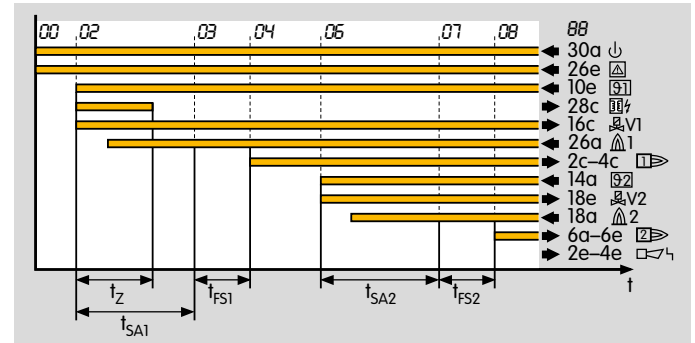

Programmable time between 0 and 25 s.

This time elapses before the PFU starts the next program step so as to give the flame time to stabilize.

4.5.5 Minimum operating time t_B

Parameter 20

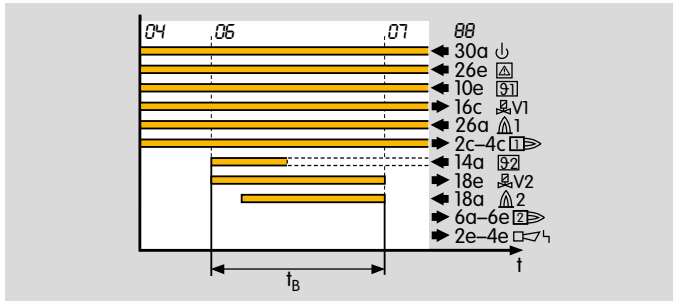

Programmable time to maximum 25 s during which the main burner remains in operation. In the case of brief activation of the start-up signal input ($\text{S}2$) (e.g. with a pulse), the operating time t_B is started, and the main burner remains in operation for at least this period.

4.5.6 Start-up attempts

Pilot burner

Parameter 10

This indicates the number of possible start-up attempts of the burner.

In accordance with EN 746-2, three start-ups are permitted in specific cases in the event of flame failure during start-up, if the safety of the installation is not impaired. Note the requirements of the Standards!

If no flame is detected during start-up, either a fault lock-out is performed or further start-up attempts in accordance with EN 746-2 occur.

Pursuant to NFPA 86, only one start-up attempt is permitted in the event of flame failure during start-up. For units approved by FM approval (see type label), it is only possible to select one start-up attempt.

1 start-up attempt

Parameter 10 = 1

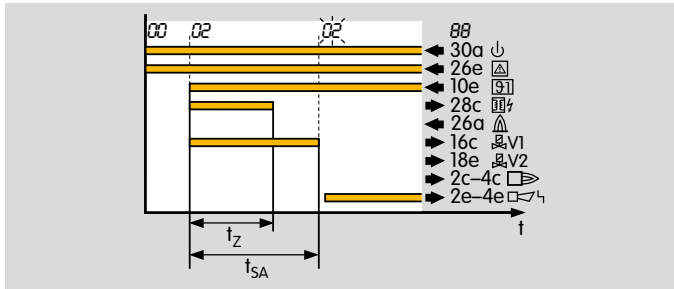

If no flame forms during start-up, a fault lock-out is performed after expiry of time t_{SA} . The display blinks and shows the cause of the fault.

2 or 3 start-up attempts

Parameter 10 = 2, 3

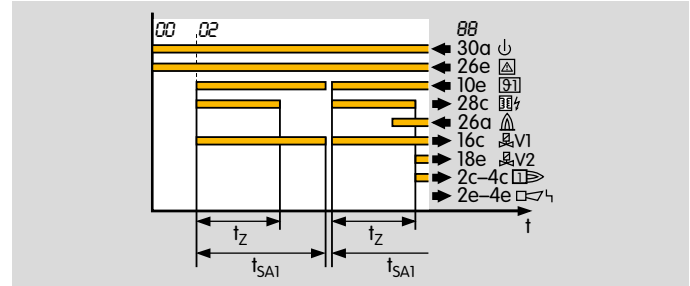

If several start-up attempts are set and if the PFU detects a flame failure during start-up, it closes valve V1 after the safety time t_{SA1} has expired and attempts to start up again. After the last programmed start-up attempt has been completed, the burner control unit conducts a fault lock-out. The display blinks and shows the cause of the fault.

Main burner

Parameter 11

This indicates the number of possible start-up attempts of the main burner.

In accordance with EN 746-2, three start-ups are permitted in specific cases in the event of flame failure during start-up, if the safety of the installation is not impaired. Note the requirements of the Standards! If no flame is detected during start-up, either a fault lock-out is performed or further start-up attempts in accordance with EN 746-2 occur.

Pursuant to NFPA 86, only one start-up attempt is permitted in the event of flame failure during start-up. For units approved by FM approval (see type label), it is only possible to select one start-up attempt.

1 start-up attempt

Parameter 11 = 1

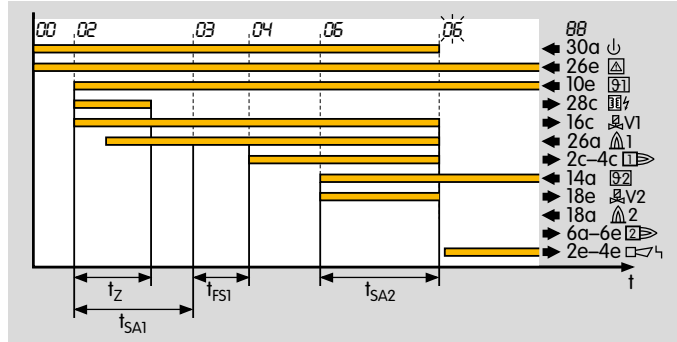

If no flame forms during the start-up of the main burner, a fault lock-out is performed after expiry of time t_{SA2} . The display blinks and shows the cause of the fault.

2 or 3 start-up attempts

Parameter 11 = 2, 3

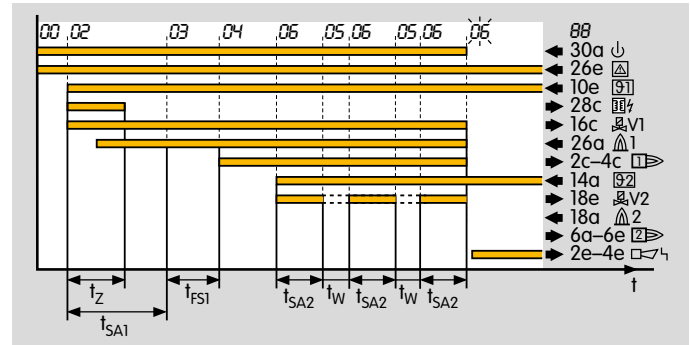

If several start-up attempts are set and if the PFU does not detect a flame signal during start-up, it closes valve V2 after the safety time t_{SA2} has expired and attempts to start up again. After the last programmed start-up attempt has been completed, the burner control unit conducts a fault lock-out. The display blinks and shows the cause of the fault.

4.6 Behaviour during operation

4.6.1 Safety time during operation t_{SB} for pilot and main burners

Parameter 14

This indicates the safety time during operation t_{SB} for valves V1 and V2. The default in accordance with EN 298 is 1 s. The PFU has also the available option of a safety time during operation t_{SB} of 2 s. Prolonging the time increases the installation availability in the case of brief-duration signal fades (e.g. fades of the flame signal). Under EN 746-2, the safety time of the installation during operation (including closing time of the valves) must not exceed 3 seconds (note the requirements of the Standards).

4.6.2 Fault lock-out or restart, pilot burner

Parameter 12

This parameter determines whether the PFU initiates a one-off restart or performs an immediate fault lock-out for the burner after an installation fault such as a flame failure or failure of air flow (see also page 45 (Project planning information)).

Immediate fault lock-out in the event of flame failure

Parameter 12 = 0:

Pilot burner fault lock-out.

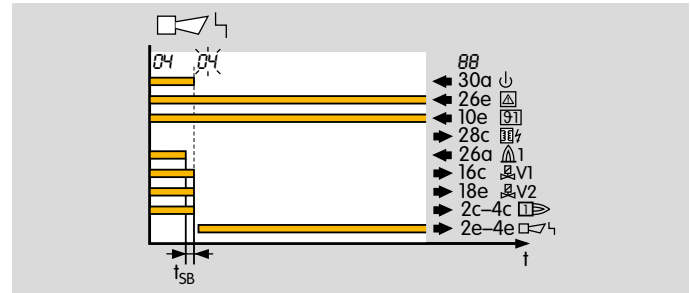

After a fault lock-out, the burner control unit can be reset, either with the button on the front panel or using an external button. Several burner control units can be reset in parallel using the external button.

The PFU cannot be reset by mains failure. The fault signalling contact does, however, open as soon as the mains voltage fails.

See also Parameter 32, page 41 (Behaviour of the air valve in the event of a fault lock-out).

Restart in the event of flame failure

Parameter 12 = 1:

Restart in the event of flame failure.

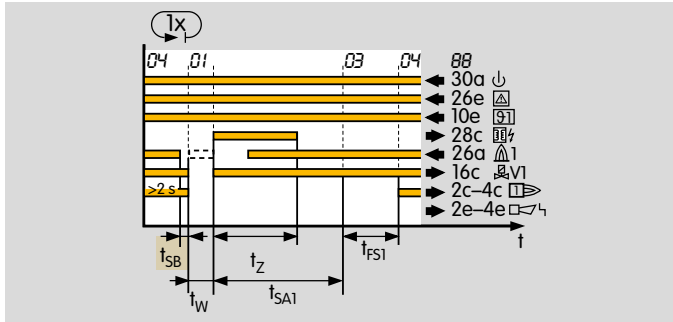

If the PFU detects a flame failure after a minimum operating time of 2 s, the valves are closed and the operation signalling contact is opened within time t_{SB} .

The burner control unit now attempts to restart the burner once. If the burner does not function, a fault lock-out occurs. The display blinks and shows the cause of the fault.

In accordance with EN 746-2, a restart may be conducted only if the safety of the installation is not impaired. Restart is recommended for burners which occasionally display unstable behaviour during operation.

The precondition for an automatic restart is that activation of the restart allows the burner to restart as intended (in all operating phases). It must be ensured that the program sequence started by the PFU matches the application in this case.

4.6.3 Fault lock-out or restart, main burner

This parameter determines whether the PFU initiates a one-off restart or performs an immediate fault lock-out for the main burner after a flame failure (see also Project planning information).

Immediate fault lock-out in the event of flame failure

Parameter 13 = 0:

Main burner fault lock-out.

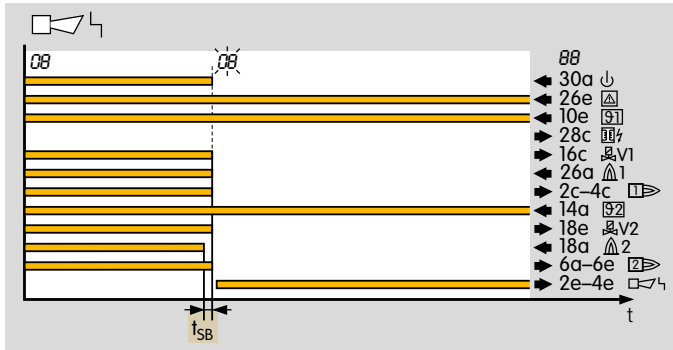

After a flame failure, the burner control unit performs a fault lock-out within the safety time during operation t_{SB} . This involves disconnecting the power from the gas valves and the ignition transformer. The fault signalling contact closes, the display blinks and shows the current program status (see table “Program status and fault messages”).

After a fault lock-out, the burner control unit can be reset, either with the button on the front panel or using an external button. Several burner control units can be reset in parallel using the external button.

The PFU cannot be reset by mains failure. The fault signalling contact does, however, open as soon as the mains voltage fails.

See also page 41 (Behaviour of the air valve in the event of a fault lock-out).

Restart in the event of flame failure

Parameter 13 = 1:

Restart in the event of flame failure.

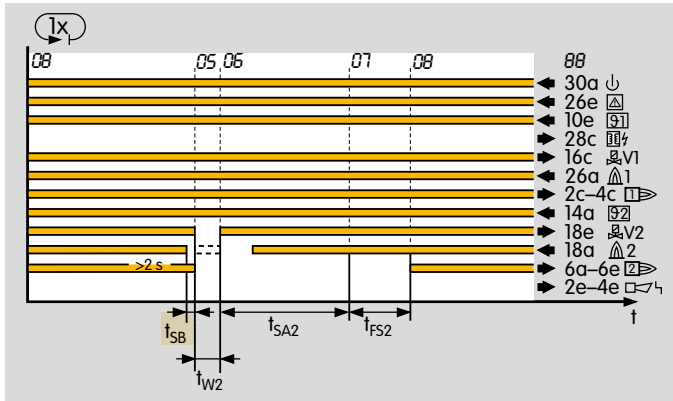

If the PFU detects a flame failure after a minimum operating time of 2 s, valve V2 is closed and the operation signalling contact is opened within time t_{SB} .

The burner control unit now attempts to restart the main burner once. If the burner does not function, a fault lock-out occurs. The display blinks and shows the cause of the fault.

In accordance with EN 746-2, a restart may be conducted only if the safety of the installation is not impaired. Restart is recommended for burners which occasionally display unstable behaviour during operation.

The precondition for an automatic restart is that activation of the restart allows the burner to restart as intended (in all operating phases). It must be ensured that the program sequence started by the PFU matches the application in this case.

4.7 Air valve control

Only on PFU..L

Parameter 30, Behaviour of the air valve during operation

Parameter 31, Behaviour of the air valve during start-up

Parameter 32, Behaviour of the air valve in the event of a fault lock-out

The PFU..L features an adjustable air valve control. The display shows that purging is currently being carried out with **PG**. **A** indicates that the air valve is being activated for cooling or heating.

The PFU..L supports the following functions:

- Purge
- Cooling in start-up position/standby
- Switching of the burner between low and high burner capacity during operation via the air valve
- To start up the burner as intended, external activation of the air valve can be blocked during start-up (prevents synchronization problems between the PFU and the central control system).
- Controlling the air valve so that it
 - opens with valve V2,
 - opens once the main burner has reached its operating position
- Low fire over-run time t_{KN} after a controlled shut-down

4.7.1 Purge

Parameter 42 = 0: the air valve is closed when voltage is applied to terminal 30e.

Parameter 42 = 1: the air valve is opened when voltage is applied to terminal 30e.

In the case of multiple burner applications, burners with mechanical combustion air supply are used. The air for combustion and pre-purge is supplied by a central fan controlled by a separate logic. This logic determines the purge time.

The PFU..L supports centrally-controlled pre-purge or post-purge. The PFU..L is informed that purging is currently being performed by input 30e. It then opens the air valve, regardless of the status of the other inputs (purging has priority). The display indicates **PG**.

PFU 780..K2: for purging, the safety interlocks (limits) must activate input 26e and input 30e of the PFU.

4.7.2 Cooling in start-up position/standby

The air valve can be activated externally via input 10a for cooling in the start-up position. During activation of the air valve, the display shows **AG**, indicating that cooling is currently being carried out.

4.7.3 Burner start

Parameters 30 and 31 determine the behaviour of the air valve during burner start.

4.7.4 Air valve opens in the case of external activation (not during start-up)

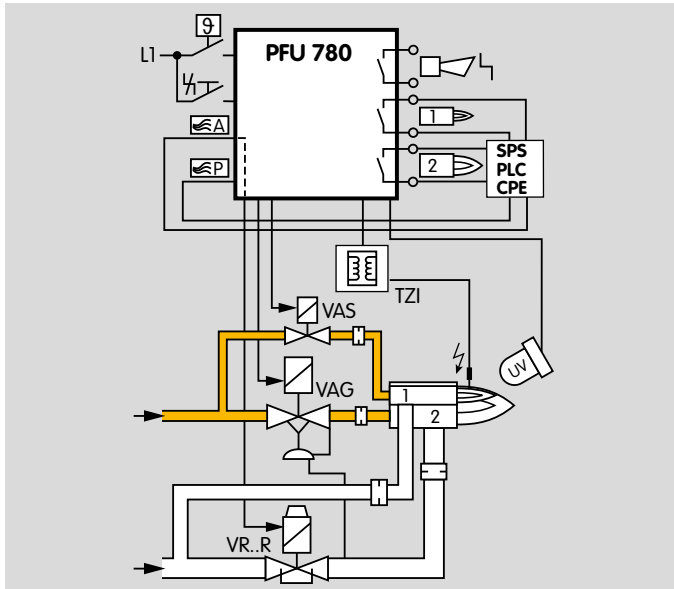
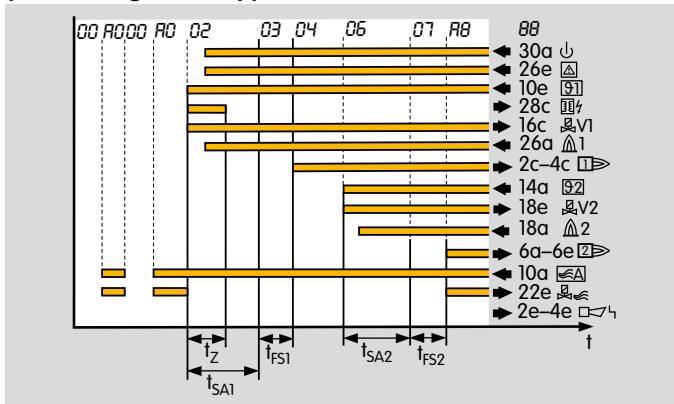

Parameter 30 = 0:

The air valve opens if it is activated externally via input 30e.

Parameter 31 = 0:

The air valve remains closed during start-up even if it is activated externally.

These settings are required on burners on which the gas/air ratio is controlled by a pneumatic air/gas ratio control system and which also need to be started at low fire, e.g. on two-stage-controlled burners. In this case, activation of the air valve during burner start via input 10a must be prevented.

External control allows switchover between low fire and high fire during operation.

The air valve can be activated externally via input 10a for cooling the burner in the start-up position/standby.

4.7.6 Air valve opens with valve V2

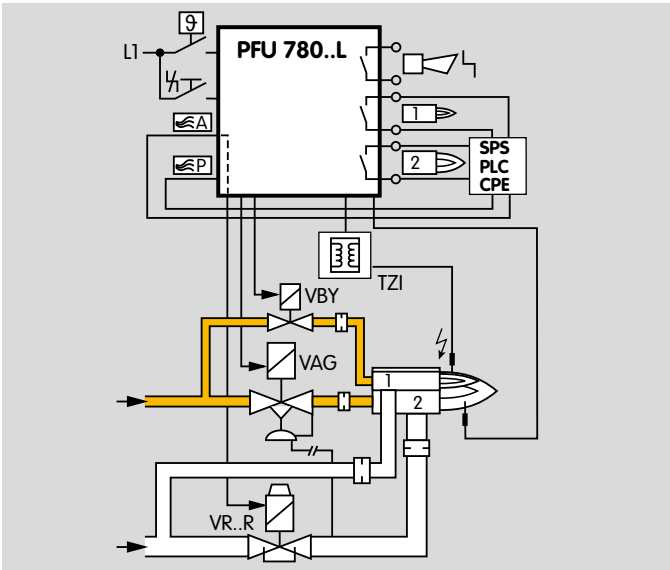
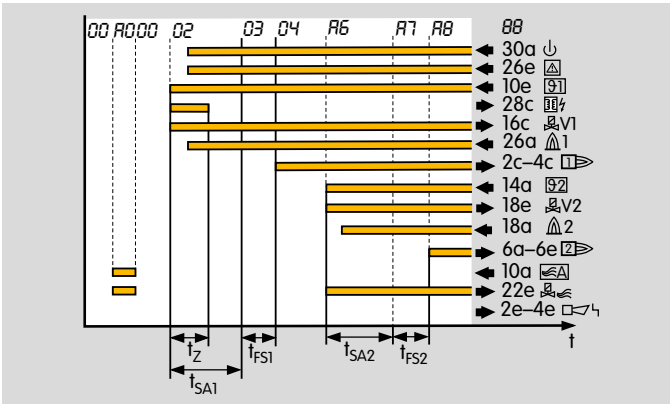

Parameter 30 = 2:

The air valve opens simultaneously with valve V2.

Application:

Single-stage-controlled main burner is switched ON/OFF via the ϑ input.

The air valve can be activated externally via input 10a for cooling the burner in the start-up position/standby.

4.7.7 Air valve opens with operating signal

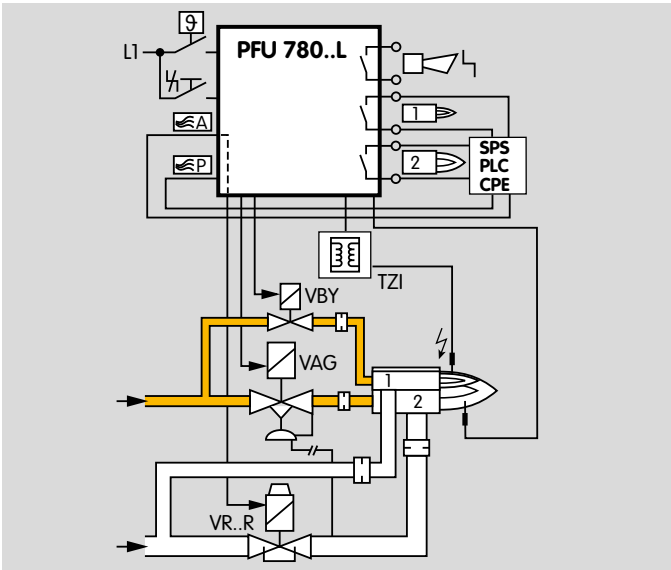
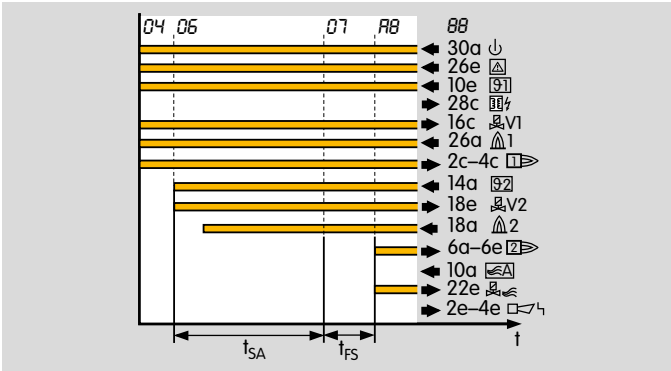

Parameter 30 = 3:

The air valve opens simultaneously with the operating signal.

Application:

Two-stage-controlled main burner is switched ON/OFF via the Φ input.

The air valve can be activated externally via input 10a for cooling the burner in the start-up position/standby.

4.7.8 Low fire over-run time t_{KN} after a controlled shut-down

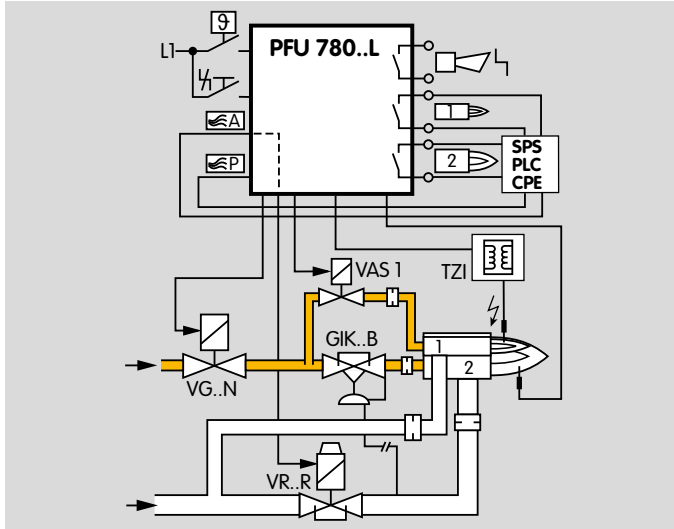
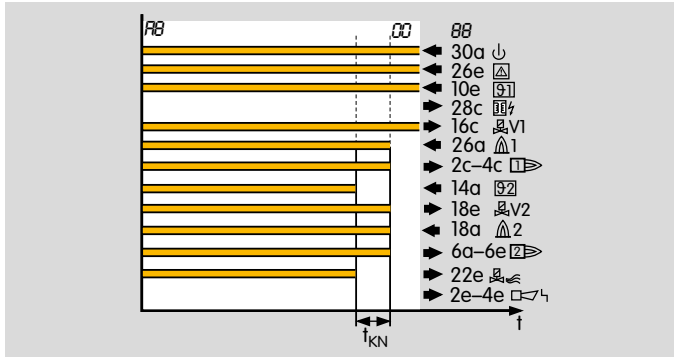

Parameter 36

Settings: 0; 3; 5; 10; 15; 25 or 60 (low fire over-run time in seconds)

This parameter is applicable to systems with a pneumatic air/gas ratio control system and On/Off control.

Parameter 36 = 0 (low fire over-run time $t_{KN} = 0$ s): without low fire over-run, the gas circuit is closed immediately owing to the quick-closing gas valve in the case of On/Off control. The air circuit is closed more slowly. The air flowing in during the closing time increases the O_2 content in the combustion chamber.

Parameter 36 = 3; 5; 10; 15; 25 or 60 (low fire over-run time $t_{KN} = 3, 5, 10, 15, 25$ or 60 s): the air valve closes slowly after the activation signal has been switched off. The gas valve remains open for t_{KN} . This means that the burner, after deactivation of the main burner start-up signal (92), is initially adjusted down to low fire and then switched off completely.

Using the low fire over-run function reduces the O_2 content in the furnace atmosphere.

Flame control is still operational. Can be used only in the case of a pneumatic air/gas ratio control system and On/Off control. It must be ensured that no excess gas occurs.

The low fire over-run time has an effect on the behaviour of the main burner only.

Reason: the pilot burner is only used in single-stage operation.

4.7.9 Behaviour of the air valve in the event of a fault lock-out

Parameter 32:

This determines whether the air valve can be activated in the case of a fault lock-out.

Parameter 32 = 0:

The air valve is closed in the event of a fault. It cannot be activated externally via terminal 10a.

Parameter 32 = 1:

The air valve can be activated externally via input 10a even during a fault, e.g. for cooling.

4.8 Manual mode

For convenient setting of the burner or analyzing faults.

The parameter display is not available in Manual mode.

Manual mode can be accessed only if the burner control unit was not in Fault state before switching off. The following times/functions are not active in Manual mode: start-up attempts, restart, minimum operating time and cycle lock.

If the Reset/Information button is pressed for 2 s during switch-on, the PFU reverts to Manual mode. Two dots blink on the display.

In this operating mode, the burner control unit operates independently of the status of the inputs (apart from the pre-purge input and the safety interlocks. These are of higher priority and will be processed first).

Each time after the button is pressed again, the PFU moves to the next section of the program sequence and stops there. After approx. 3 s, the flame signal will be displayed instead of the program parameter. Briefly pressing the Reset/Information button (< 1 s) displays the relevant Manual mode step. If there is flame simulation during start-up, the flame signal is displayed immediately.

On units with air valve control, the air valve can be opened and closed repeatedly by pressing the button during operation. Manual mode can be terminated by switching off the PFU (On/Off button).

4.8.1 Manual mode limited to 5 minutes

Parameter 34

Parameter 34 determines when Manual mode is terminated.

Parameter 34 = 0:

Manual mode is not limited in time. If this function has been selected, operation of the furnace may be continued manually in the event of failure of the central control system.

Parameter 34 = 1:

Manual mode ends automatically five minutes after the last time the button was pressed. The PFU then moves abruptly back to start-up position/standby.

4.9 Password

Parameter 50:

(Four-digit) password saved to protect parameter settings. To prevent unauthorized changes to parameter settings, a password is stored in parameter 50. Changes to parameter settings can only be made once this number has been entered. The password can be changed using BCSoft.

Note the effect of parameter settings on the safe functioning of your system.

The password set at the factory can be found in the delivery note supplied.

5 Selection

5.1 Calculating the safety time t_{SA}

See www.adlatus.org

5.2 Selection table

Option	PFU
Series 700	7
Version for pilot and main burners	80
Air valve control	L
Mains voltage	-3, T , N
Digital input for high temperature operation	D*
Configured and prepared for UVC 1	U*
Replacement for PFU 778/798	K2*

* If "none", this specification is omitted.

Order example

PFU 780LT

5.2.1 Type code

PFU	Burner control unit
7	Series 700
60	Standard version
80	Version for pilot and main burners
L	Air valve control
T	Mains voltage 220/240 V AC, 50/60 Hz, for grounded and ungrounded mains
N	Mains voltage 110/120 V AC, 50/60 Hz, for grounded and ungrounded mains
D	Digital input for high temperature operation
U	Configured and prepared for UVC 1
K1	Replacement for PFS/PFD
K2	Replacement for PFU 778/798

6 Project planning information

6.1 Cable selection

Use mains cable suitable for the type of operation and complying with local regulations. Do not route PFU 780 cables in the same cable duct as frequency converter cables or cables emitting strong fields.

6.1.1 Ignition cable

Use unscreened high-voltage cable, see page 51 (High-voltage cable). Cable length: max. 5 m, recommended < 1 m. Screw the ignition cable securely into the ignition transformer and run to the burner by the shortest possible route.

The longer the ignition cable, the lower the ignition capacity. Only use radio interference suppressed terminal boots (with 1 k Ω resistor) for spark electrodes, see page 52 (Radio interference suppressed terminal boots). Do not lay UV/ionization cable and ignition cable together and lay them as far apart as possible.

6.1.2 Ionization cable

Use unscreened high-voltage cable, see page 51 (High-voltage cable). Cable length: max. 100 m. External electrical interference must be avoided. Install as far as possible from mains and ignition cables and interference from electromagnetic sources. If possible, do not lay in a metal conduit. Several ionization cables can be routed together.

6.1.3 UV cable

Cable length: max. 100 m. External electrical interference must be avoided. Install as far as possible from mains and ignition cables and interference from electromagnetic

sources. If possible, do not lay in a metal conduit. Several UV cables can be routed together.

6.2 Spark electrode

6.2.1 Electrode gap

Gap between electrode and burner ground:
2 mm \pm 0,5 mm.

6.2.2 Star electrodes

We recommend using 7.5 kV ignition transformers on burners with star electrodes.

6.3 Minimum operating time

Even if the start-up signal (ϑ) is applied only briefly, the time set under parameter 20 elapses before the burner control unit shuts down the burner or signals a fault. To stabilize the burner operation, a minimum operating time can be set independently of the central control system. If the start-up signal (ϑ) drops once the second safety time t_{SA2} has started to elapse, the burner remains in operation for at least time t_B . The minimum operating time t_B starts to elapse following controller enable. If the start-up signal drops before the second safety time t_{SA2} , e.g. during pre-purge, the control unit reverts directly to standby and the burner is not ignited.

The signal inputs for the pilot/main burner start-up signal cannot be used for a safety shut-down because the unit controls the valves until the minimum operating time has elapsed.

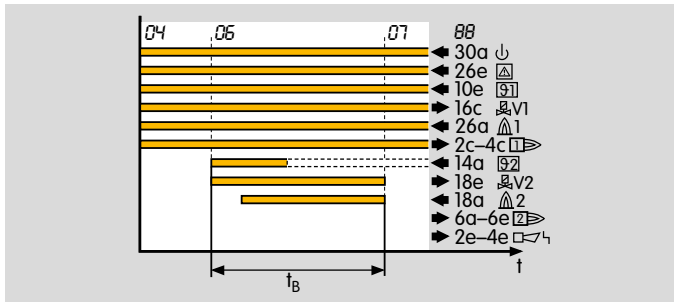

In the case of pilot/main burner monitoring, the minimum operating time only has an effect on the behaviour of the main burner. The minimum operating time for the pilot burner is limited to the safety time on start-up (t_{SA1}).

Reason: the pilot burner is only used in single-stage operation.

6.4 Safety interlocks (limits)

The limiters in the safety interlock (linking of all the relevant safety-related control and switching equipment for the use of the application, e.g. safety temperature limiter, minimum and maximum gas pressure, tightness control) must isolate terminal 26e from the voltage supply. If the safety interlock is interrupted, this is indicated by a blinking 5f on the display.

If the safety interlocks fail, an immediate program abort with switch-off of all outputs occurs (even during the safety time). If the safety interlocks are operational again or the unit is switched back on, the program run is restarted in standby.

6.5 Emergency stop

6.5.1 In the event of fire or electric shock

If there is a risk of fire, electric shock or similar, inputs L1, N and 26e (safety interlocks) of the PFU should be disconnected from the electrical power supply – this should be reflected in the wiring on site.

6.5.2 Via the safety interlocks (limits)

The safety interlocks turn off the power to input 26e, such as in the event of low air pressure or similar.

6.6 Reset

6.6.1 Parallel reset

Several burner control units can be reset in parallel using the external button. The PFU cannot be reset by mains failure.

6.6.2 Permanent remote reset

Several burner control units can be reset in parallel using the external button. The PFU cannot be reset by mains failure.

6.6.3 Automatic remote reset (PLC)

In the case of automatic remote reset (PLC), the reset pulse duration should not exceed 1 second. Check compliance with Standards.

If a fault is acknowledged by remote reset too often, error  (Too many remote resets) is displayed. The error can only be acknowledged with the Reset/Information button on the unit.

The burner malfunction must be remedied. The malfunction cannot be remedied by changing the method of activation.

6.6.4 Burner start

A furnace start may only be initiated, if it has been ensured using an appropriate procedure that there is no combustible mixture in the combustion/processing chamber, in the connected areas or in the flue gas system (heat exchanger, dust collector). This can be achieved by pre-purge, which occurs immediately before ignition or within the period specified in the operating instructions.

In the case of multiple burner applications, pre-purge is not necessary after a controlled burner shut-down.

Note the requirements of the Standards. For exceptions, see Standards.

6.6.5 Restart and start-up attempts

The precondition for a restart/start-up attempt is that activation of the restart allows the burner to restart as intended (in all operating phases). It must be ensured that the program sequence started by the PFU matches the application in this case.

Note the requirements of the Standards. For exceptions, see Standards.

6.7 Fault signal

The fault signalling contact opens, as soon as the mains voltage fails.

6.8 Protecting the pilot burner from overload

To protect the unit against overload by frequent cycling, the maximum number of start-ups per minute is limited for the PFU. Excessive cycling triggers a fault message (blinking 53). The max. number of start-ups per minute depends on the safety time t_{SA} :

t [s]	Ignition transformer TZI	Max. start-ups/min.
3	5-15/100	6
5	5-15/100	5
10	5-15/100	4

6.9 Installation

Installation position as required. Installation in 19" module subracks only, see page 52 (Module subrack).

Install in clean environment ensuring enclosure IP 54 or higher, whereby no condensation is permitted. Cable length between PFU and burner: max. 100 m.

6.10 Wiring

The PFU is suitable for hard wiring only. Do not reverse phase and neutral conductor. Different phases of a three-phase current system must not be installed at the PFU. No voltage may be connected to the valve and ignition outputs.

6.10.1 UVS sensor wiring

Connect the UVS sensor directly to the PFU. Operating the sensor with incorrect polarity or voltage can lead to destruction of the sensor.

6.11 PFU switched off

The PFU cannot be activated when no mains voltage is applied or when it is switched off. The fault signalling contact is only closed when the unit is supplied with voltage and switched on.

If the unit is switched off, an immediate program abort with switch-off of all outputs occurs (even during the safety time). When the unit is switched on, the program run is restarted in standby.

6.12 Furnace control

Switch on the system to start up the furnace, then release the burner start via the safety interlocks and afterwards start the burner control so that the burner control unit may monitor the burners as intended. To shut down the furnace, first disconnect the burner control unit from the temperature control (burner ON signal), then disconnect the safety interlocks and finally switch off the system.

6.13 Note on EC-type examination

Since EN 298 (1993) does not describe all functions of the PFU, the operator is responsible for ensuring that all parameters and functions are matched to the respective application.

6.14 Mains switch

The mains switch in the unit isolates the PFU on two poles from the mains. It does not meet the requirements of EN 50156-1:2004 (5.2.2 Disconnecting switch) set out in chapter 5 for a device to disconnect the power supply. Although the mains switch cannot be used for disconnecting from the electrical power supply in accordance with EN 50156, it does allow the burner to be isolated functionally from the central control system. This function is required for manual operation and, in the case of PROFIBUS units, to switch off the unit without causing bus errors. Disconnection for electrical maintenance work is to be implemented with an external switch per unit or group only, in accordance with Standard EN 50156.

6.15 Changing parameters

In certain cases, it may be necessary to change the default settings. Using a separate software package and a PC opto-adapter, it is possible to modify certain parameters on the PFU, such as the switch-off threshold of the flame amplifier, the behaviour in the event of a flame failure or whether the pilot burner is to burn permanently in the case of pilot and main burner monitoring.

The software package with PC opto-adapter, as well as “Changed parameters” stickers, are available as accessories, see page 51 (Accessories).

The device parameters set at the factory are specified in the delivery note.

Document changed parameters in BCSOFT using the protocol function and enclose the protocol with the plant documentation.

If a replacement is ordered for a PFU with changed parameters, refer to the protocol for details.

7 Flame control

7.1 With flame rod

The PFU generates an alternating voltage (230 V AC) between the sensing electrode and burner ground. The flame rectifies this voltage. Only the DC signal (depending on the switch-off threshold, page 17 (Switch-off threshold of the flame amplifier)) is recognized by the burner control unit as a flame signal. A flame cannot be simulated. Ignition and monitoring with a single electrode is possible.

7.2 With UV sensor

A UV tube inside the UV sensor detects the ultraviolet light of a flame. It does not respond to sunlight, incandescent bulb light or infrared radiation emitted by hot workpieces or red-hot furnace walls.

In the event of incident UV radiation, the UV sensor rectifies the supplied alternating voltage. As with ionization control, the burner control unit only detects this DC signal.

When using UV sensors of Type UVS, the burner control unit may be used for intermittent operation only. This means that operation must be interrupted at least once every 24 hours. This can be programmed using parameter 35.

For more information: see brochure UVS. The burner control unit PFU..U is prepared for UV sensor UVD 1. This enables continuous operation. For more information: see Technical Information UVD.

7.3 Via the temperature in high temperature equipment

High temperature equipment is defined as a thermoprocessing installation, in which the wall temperature of the combustion chamber and/or the processing chamber exceeds 750°C. Burner control unit PFU..D features a special “High temperature operation” function. During heating up, standard monitoring methods (ionization or UV) must be used for flame control. When the working temperature has exceeded 750°C, indirect flame control can be taken over by a central monitoring device. When the DI input (terminal 22a) is activated, the burner control unit reverts to this operating mode.

Attention: in “High temperature operation”, i.e. with the DI input being activated, burner control unit PFU..D does not evaluate the flame signal. The safety function of the burner control unit’s flame control is deactivated during this operating phase.

8 Accessories

8.1 High-voltage cable

FZLSi 1/7 -50°C (-58°F) to +180°C (+356°F),
Order No.: 04250410,
FZLK 1/7 -5°C (23°F) to +80°C (176°F),
Order No.: 04250409.

8.2 BCSoft

The current software can be downloaded from our Internet site at www.docuthek.com. To do so, you need to register in the DOCUTHEK.

8.2.1 Opto-adaptor PCO 200



Including BCSoft CD-ROM,
Order No.: 74960625.

8.3 Stickers for labelling



For printing with laser printers, plotters or engraving machines, 27 × 18 mm or 28 × 17.5 mm.

Colour: silver

8.4“Changed parameters” stickers



Affix on the connection diagram of the PFU following changes to device parameters set at the factory.

100 pcs, Order No.: 74921492.

8.5 Radio interference suppressed terminal boots

Right-angle terminal boot, 4 mm, interference-suppressed, Order No. 04115308.

Straight terminal boot, 6 mm, interference-suppressed, Order No. 04115306.

8.6 Socket connectors

Type	Order No.
Socket connector E, 48-pin solder tag connection	04120148
Socket connector E, 48-pin wire-wrap connection	04120158

8.7 Module subrack

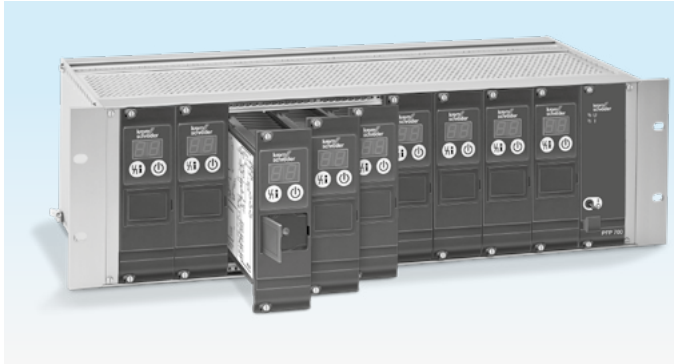

Module subrack BGT S-9U/1 for PFP 700, PFU 780 comprising:

module subrack, printed-circuit board with rear terminal strip, function-tested, standard documentation, guide rails, without partial front plates, screw terminals at the rear.

Slots 1–9 for PFU 760/780, slot 10 for PFP 700, Order No. 84402281

Module subrack BGT SM-8/1/1 for MPT 700, PFU 780 comprising:

module subrack, printed-circuit board with rear terminal strip, function-tested, standard documentation, guide rails, without partial front plates, screw terminals at the rear, single-zone operation for MPT 700 operating modes 1–4, two-zone operation for MPT 700 operating modes 1–4, but max. 4 burners per zone.

Slot 1 for MPT 700, slots 2–9 for PFU 760/780, slot 10 for PFP 700

Order No. 84402282 (no illustration provided)

Module subrack BGT SA for PFA 700/PFU 760 and PFA 710/PFU 780

comprising:

module subrack, printed-circuit board with rear terminal strip, function-tested, standard documentation, guide rails, without partial front plates, screw terminals at the rear, relays and screw terminals for four free inputs and four free outputs, connection to PROFIBUS DP with D-Sub socket.

BGT SA-9: slot 1 for PFA 700, slots 2–10 for PFU 760,

BGT SA-8: slot 1 for PFA 710, slots 2–9 for PFU 780

Order No.

BGT SA-9U/1 DP700: 84402291

BGT SA-8U/1 DP710: 84402292 (no illustration provided)

8.8 Power supply PFP 700

For supplying the control inputs of burner control unit PFU or for supplying the auxiliary voltage to relay module PFR 704. Operating status display on the front panel. PFP switches off in the event of an output overload.

Output voltage 24 V, output rating 14 VA.

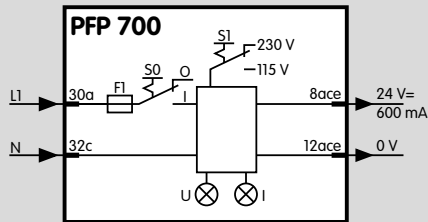

8.9 Relay module PFR 704

For contact multiplication, e.g. if several air valves are activated via one control signal for pre-purge, or for heating/cooling switchover when using an MPT. Switching status display on the front panel.

Input voltage: 110/120 V AC, -15/+10%, 50/60 Hz,
220/240 V AC, -15/+10%, 50/60 Hz, 24 V AC/DC, ±10%.

Current per relay: 25 mA.

Contact rating of floating outputs: max. 2 A, 264 V (not fused internally).

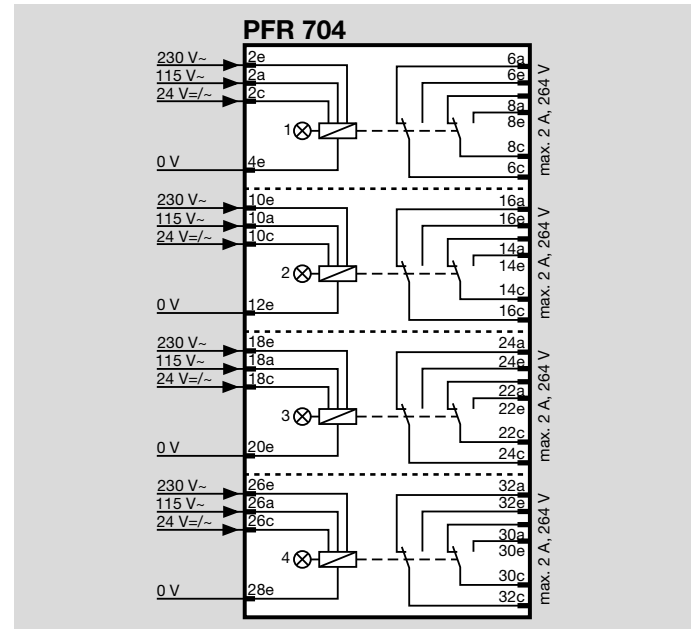

8.10 Fieldbus interface PFA 700

For connection of up to nine burner control units PFU 760 to industrial communication networks using PROFIBUS DP, in order to transfer measuring, control and regulation signals as a bundle. 4 digital inputs: 24 V DC, $\pm 10\%$, $< 10\text{ mA}$, 4 digital outputs: relay contact, max. 1 A, 264 V (not fused internally). Mains voltage: 110–240 V AC, $-15/+10\%$, 50/60 Hz. For further information, see Technical Information PFA.

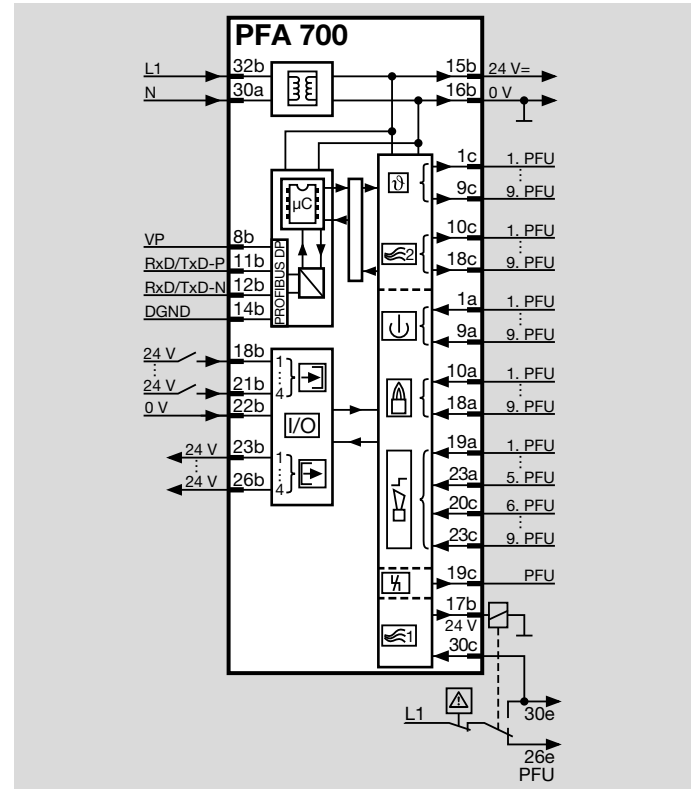

8.11 Impulse system MPT 700

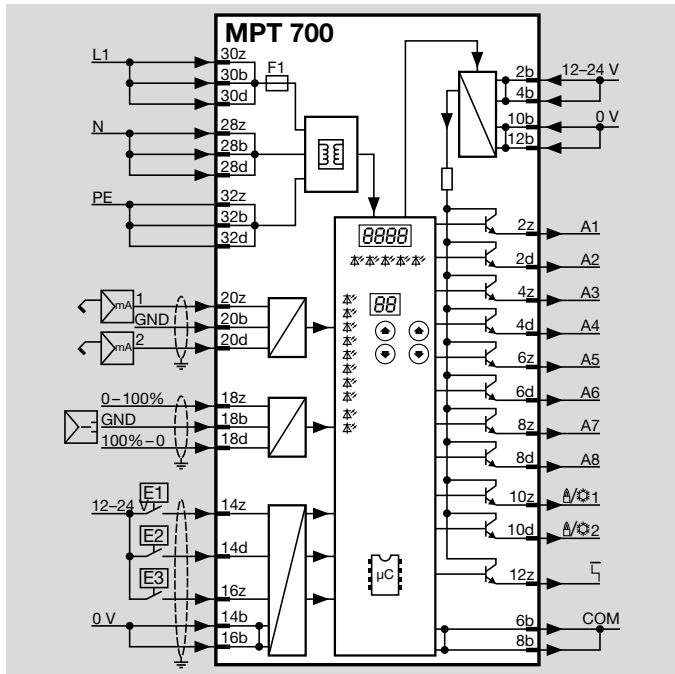
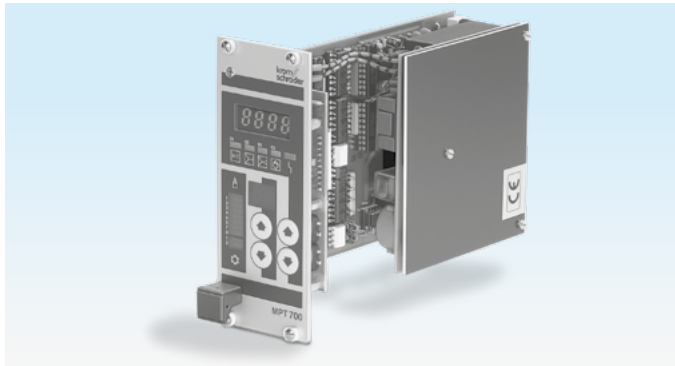

With 11 outputs for activation of burner control units PFU 780. The furnace atmosphere is circulated thanks to intermittent operation, and thereby constant temperature distribution and shorter heating-up periods for all gas-fired heat treatment furnaces are ensured.

Mains voltage: 95–240 V AC, $\pm 10\%$, 50/60 Hz.

Power consumption: 10 VA.

Additional auxiliary voltage: 12–24 V DC, $\pm 10\%$, max. 1.1 A.

Controller inputs: 2 x 0(4) to 20 mA with common ground, floating, load impedance approx. 225 Ω .

Three-point step input: floating, 12–24 V DC, load impedance approx. 2.7 k Ω .

Digital inputs E1–E3: with common ground, floating, 12–24 V DC, load impedance approx. 2.7 k Ω .

Order No.: 84395050

For further information, see brochure MPT.

9 Technical data

Ambient conditions

Condensation and dew in and on the unit are not permitted.
Avoid direct sunlight or radiation from red-hot surfaces on the unit.

Avoid corrosive influences, e.g. salty ambient air or SO₂.

Ambient temperature: -20 to +60°C (-4 to +140°F).

No condensation permitted.

Enclosure: IP 00, after installing in a module subrack BGT..1DP700 or

BGT..1DP710 according to the instructions, the front corresponds to IP 20 pursuant to IEC 529.

Permitted operating altitude: < 2000 m AMSL.

Mechanical data

Number of operating cycles:

max. 1,000,000 for 1 A resistive load.

Mains switch: 1000,

Reset/Information button: 1000.

Weight: approx. 0.65 kg (1.43 lb).

Electrical data

Mains voltage:

PFU..T: 220/240 V AC, -15/+10%, 50/60 Hz,

PFU..N: 110/ 120 V AC, -15/+10%, 50/60 Hz,

for grounded or ungrounded mains. Voltage for valves = mains voltage.

Input voltage of signal inputs:

Rated value	110/120 V AC	220/240 V AC
Signal "1"	80–132 V	160–264 V
Signal "0"	0–20 V	0–40 V
Frequency	50/60 Hz	50/60 Hz

Rated value	24 V DC
Signal "1"	24 V, ±10%
Signal "0"	< 1 V

Inherent current: Signal "1" = typ. 5 mA

Power consumption:

8 VA plus inherent consumption of the ignition transformer.

Inherent consumption of ignition transformer:

TZI 5-15/100:		
Input	230 V AC,	0.45 A at 50 Hz,
		0.35 A at 60 Hz.
	115 V AC,	0.9 A at 50 Hz,
		0.7 A at 60 Hz.
Output	5000 V AC,	15 mA at 50 Hz,
		11 mA at 60 Hz.

TZI 7-25/20:		
Input	230 V AC,	1.1 A at 50 Hz,
		0.8 A at 60 Hz.
	115 V AC,	2.2 A at 50 Hz,
		1.6 A at 60 Hz.
Output	7000 V AC,	25 mA at 50 Hz,
		18 mA at 60 Hz.

TZI 7.5-20/33:		
Input	230 V AC,	0.9 A at 50 Hz,
		0.7 A at 60 Hz.
	115 V AC,	1.8 A at 50 Hz,
		1.35 A at 60 Hz.
Output	7500 V AC,	20 mA at 50 Hz,
		15 mA at 60 Hz.

TZI 7.5-12/100:		
Input	230 V AC,	0.6 A at 50 Hz,

TZI 7.5-12/100:

		0.45 A at 60 Hz.
	115 V AC,	1.2 A at 50 Hz,
		0.9 A at 60 Hz.
Output	7500 V AC,	12 mA at 50 Hz,
		9 mA at 60 Hz.

Output current: max. 2 A per output, but total current for valves and ignition transformer:

max. 2.5 A. Operation and fault signalling contacts:
dry contact (floating), max. 1 A, 24 V, not fused internally.

Flame control:

sensor voltage: approx. 230 V AC,

sensor current: > 1 μ A.

Length of sensor cable:

max. 100 m (328 ft).

Fuse in unit:

F1: 3.15 A, slow-acting, H,

pursuant to IEC 127-2/5,

F3: 3.15 A, slow-acting, H,

pursuant to IEC 127-2/5.

Fail-safe inputs and outputs:

All the inputs and outputs marked “” (see page 11 (Connection diagram)) may be used for safety tasks.

9.1 Safety-specific characteristic values for SIL and PL

Certificates – see www.docuthek.com.

Pursuant to EN ISO 13849-1:2006, Table 4, the PFU can be used up to PL e.

Max. service life under operating conditions:
20 years after date of production, plus max. 6 months in storage prior to first use.

For a glossary of terms, see page 63 (Glossary).

Suitable for Safety Integrity Level	SIL 3
Diagnostic coverage DC	97.9%
Type of subsystem	Type B to EN 61508-2, 7.4.3.1.4
Mode of operation	High demand mode pursuant to EN 61508-4, 3.5.12
Mean probability of dangerous failure PFH _D	1.34×10^{-8} 1/h
Mean time to dangerous failure MTTF _d	$MTTF_d = 1/PFH_D$
Safe failure fraction SFF	99.2%

The specified values apply for the combination with flame rod (sensor) and PFU 780 (logic).

Relationship between the Performance Level (PL) and the Safety Integrity Level (SIL)

PL	SIL
a	–
b	1
c	1
d	2
e	3

9.2 Operating controls

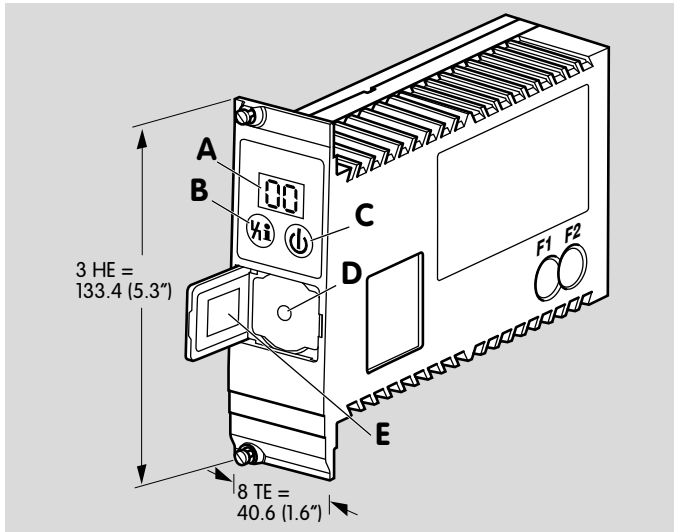

A: 2-digit 7-segment display

B: Reset/Information button to reset the system after a fault or to scan parameters on the display.

C: Mains switch

D: Optical interface

E: Type label

10 Maintenance cycles

The products PFU 780 require little servicing.

11 Legend

	Display
	Blinking display
	Safety interlocks (Limits)
	Start-up signal, pilot burner
	Start-up signal, main burner
	Digital input
	Ignition transformer
	Gas valve
	Air valve
	Flame signal
	Purge
	Ext. air valve control
	Operating signal, pilot burner
	Operating signal, main burner
	Fault signal
	Reset/Information
	Reset
	Input signal
	Output signal
	Flame simulation check
	Ignition/High voltage
	Ionization
	Input/Output safety circuit
t_w	Waiting time

t_{LV}	Flame simulation delay time
t_z	Ignition time
t_{SA}	Safety time on start-up 3 s, 5 s or 10 s
t_{SB}	Safety time during operation < 1 s or < 2 s
t_{FS}	Flame proving period
t_B	Minimum combustion time
t_{BP}	Minimum burner pause time
t_{KN}	Low fire over run time

12 Glossary

12.1 Waiting time t_W

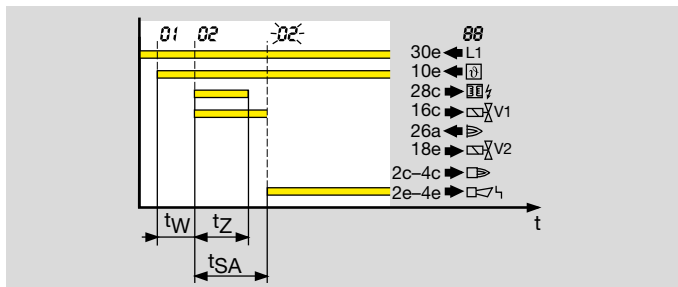

Once the start-up signal ϑ has been applied, the waiting time t_W starts to elapse. During this time, a self-test is conducted to detect errors in internal and external circuit components. If no malfunction is detected, the burner will start up.

12.2 Safety time on start-up t_{SA1}

This refers to the period of time between switching on and switching off of the gas valve, when no flame signal is detected. The safety time on start-up t_{SA1} is the minimum operating time of the burner 1 and burner control unit.

12.3 Ignition time t_Z

If no malfunction is detected during the waiting time t_W , the ignition time t_Z then starts to elapse. Voltage is supplied to the pilot gas valve V1 and the ignition transformer and the burner is ignited. The duration of the ignition time is either 2, 3 or 7 seconds (depending on safety time t_{SA} selected).

12.4 Flame simulation/Flame simulation delay time t_{LV}

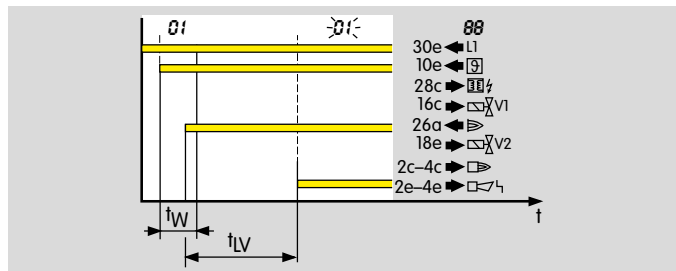

An extraneous signal (flame simulation) is a flame signal that is detected, although there should be no flame according to the program sequence. If such an extraneous signal is detected, the flame simulation delay time t_{LV} starts to elapse. If the flame simulation is discontinued during the flame simulation delay time t_{LV} , start-up can be initiated or operation continued. Otherwise, a fault lock-out occurs.

12.5 Safety time during operation t_{SB}

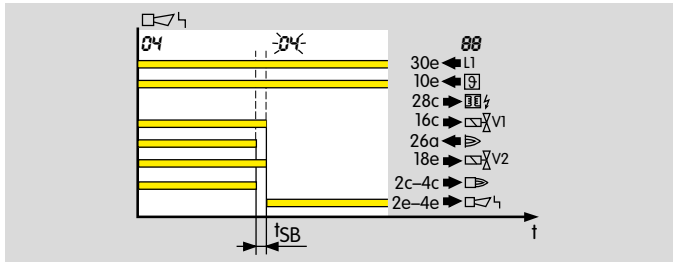

If the flame fails during operation, the valve outputs are disconnected within the safety time t_{SB} .

The default safety time during operation t_{SB} in accordance with EN 298 is 1 s. Under EN 746-2, the safety time of the installation during operation (including closing time of the valves) must not exceed 3 s, see page 45 (Project planning information). Note the requirements of the standards!

12.6 Flame signal

If a flame is detected, the flame detector will supply a flame signal.

12.7 Fault lock-out

In the event of a fault lock-out, all valves and the ignition transformer are disconnected from the electrical power supply, and a fault is signalled. Resetting must take place manually following a fault lock-out.

12.8 Safety interlocks (Limits)

The limiters in the safety interlock (linking of all the relevant safety control and switching equipment for the use of the

application, e.g. safety temperature limiter, minimum/maximum gas pressure) must isolate input (Δ) from the voltage supply.

12.9 Pilot gas valve V1

The start fuel flow rate for the pilot burner is released by pilot gas valve V1. It opens when the safety time on start-up t_{SA1} starts to elapse. It remains open until the burner is switched off again by a controlled shut-down or fault lock-out.

12.10 Main gas valve V2

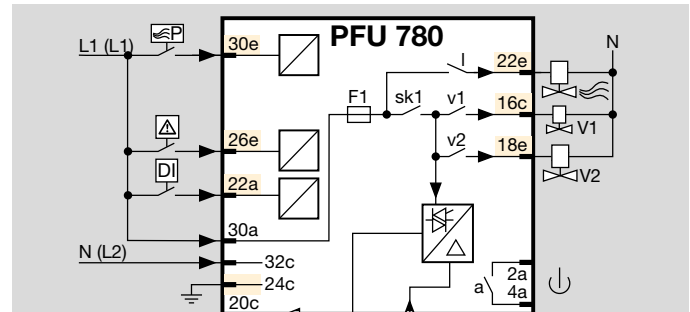

The start fuel flow rate for the main burner is released by main gas valve V2. It opens when the safety time on start-up t_{SA2} starts to elapse. It remains open until the burner is switched off again by a controlled shut-down or fault lock-out.

12.11 Continuous operation

The gas burner runs continuously for more than 24 hours.

12.12 Air valve

The air valve can be used

- for cooling,
- for purging,
- to control the burner capacity in ON/OFF mode and in High/Low mode when using a pneumatic air/gas ratio control system.

12.13 Diagnostic coverage DC

Measure of the effectiveness of diagnostics, which may be determined as the ratio between the failure rate of detected dangerous failures and the failure rate of total dangerous failures

NOTE: Diagnostic coverage can exist for the whole or parts of a safety-related system. For example, diagnostic coverage could exist for sensors and/or logic system and/or final elements. Unit: %

see EN ISO 13849-1

12.14 Mode of operation

High demand mode or continuous mode

Operating mode, where the frequency of demands for operation made on a safety-related system is greater than one per year or greater than twice the proof-test frequency

see EN 61508-4

12.15 Safe failure fraction SFF

Fraction of safe failures related to all failures, which are assumed to appear

see EN 13611/A2

12.16 Probability of dangerous failure PFH_D

Value describing the likelihood of dangerous failure per hour of a component for high demand mode or continuous mode. Unit: 1/h

see EN 13611/A2

12.17 Mean time to dangerous failure MTTF_D

Expectation of the mean time to dangerous failure

see EN ISO 13849-1:2008

Fore more information

The Honeywell Thermal Solutions family of products includes Honeywell Combustion Safety, Eclipse, Exothermics, Hauck, Kromschroder and Maxon. To learn more about our products, visit ThermalSolutions.honeywell.com or contact your Honeywell Sales Engineer.

Elster GmbH
Strotheweg 1, D-49504 Lotte
T +49 541 1214-0
hts.lotte@honeywell.com
www.kromschroeder.com

© 2020 Elster GmbH

We reserve the right to make technical modifications in the interests of progress.

