

## Operating instructions

**Pressure regulators with solenoid valve VAD, VAG, VAV, VAH**

**Flow rate regulator VRH**

**Pressure regulators with double solenoid valve VCD, VCG, VCV, VCH**

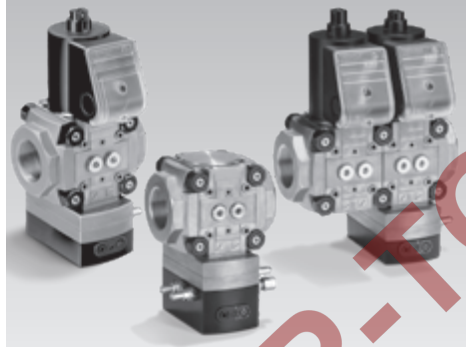

Cert. version 07.19

## Contents

<b>Pressure regulators with solenoid valve VAD, VAG, VAV, VAH</b>	<b>1</b>
<b>Flow rate regulator VRH</b>	<b>1</b>
<b>Pressure regulators with double solenoid valve VCD, VCG, VCV, VCH</b>	<b>1</b>
<b>Checking the usage</b>	<b>2</b>
<b>Installation</b>	<b>3</b>
<b>Installing the gas/air control lines</b>	<b>5</b>
<b>Wiring</b>	<b>6</b>
<b>Tightness test</b>	<b>8</b>
<b>Commissioning</b>	<b>9</b>
<b>Replacing the actuator</b>	<b>11</b>
<b>Maintenance</b>	<b>11</b>
<b>Accessories</b>	<b>11</b>
Pressure switch for gas DG..VC	11
Bypass/pilot gas valves	12
Checking the bypass/pilot gas valve for tightness	13
Cable gland set for double solenoid valves	14
Attachment block	15
Seal set for sizes 1–3	15
Cable gland with pressure equalization element	15
<b>Technical data</b>	<b>16</b>
<b>Logistics</b>	<b>18</b>
<b>Certification</b>	<b>18</b>
<b>Contact</b>	<b>20</b>

## Safety

### Please read and keep in a safe place



Please read through these instructions carefully before installing or operating. Following the installation, pass the instructions on to the operator. This unit must be installed and commissioned in accordance with the regulations and standards in force. These instructions can also be found at www.docuthek.com.

### Explanation of symbols

■, **1**, **2**, **3**... = Action  
 ▷ = Instruction

### Liability

We will not be held liable for damage resulting from non-observance of the instructions and non-compliant use.

### Safety instructions

Information that is relevant for safety is indicated in the instructions as follows:

#### **⚠ DANGER**

Indicates potentially fatal situations.

#### **⚠ WARNING**

Indicates possible danger to life and limb.

#### **! CAUTION**

Indicates possible material damage.

All interventions may only be carried out by qualified gas technicians. Electrical interventions may only be carried out by qualified electricians.

### Conversion, spare parts

All technical changes are prohibited. Only use OEM spare parts.

## Changes to edition 01.19

The following chapters have been changed:

- Cert. version

## Checking the usage

### Intended use

#### Pressure regulators with solenoid valve VAD, VAG, VAV, VAH

Type	Designation of regulator type
VAD	Pressure regulator with solenoid valve
VAG	Air/gas ratio control with solenoid valve
VAV	Variable air/gas ratio control with solenoid valve
VAH	Flow rate regulator with solenoid valve

Constant pressure governor VAD for shut-off and precise control of the gas supply to excess air burners, atmospheric burners or force draught gas burners. Air/gas ratio control VAG for shut-off and for maintaining a constant air/gas pressure ratio of 1:1 for modulating-controlled burners or with bypass valve for stage-controlled burners. Can be used as zero governor for gas engines.

Variable air/gas ratio control VAV for shut-off and for maintaining a constant air/gas pressure ratio for modulating-controlled burners. The transmission ratio of gas to air can be set from 0.6:1 to 3:1. Pressure fluctuations in the combustion chamber can be compensated via the combustion chamber control pressure  $p_{sc}$ .

Flow rate regulator VAH for maintaining a constant gas/air ratio for modulating-controlled and stage-controlled burners. The gas flow rate is controlled proportionally to the air flow rate. In addition, the flow rate regulator with gas solenoid valve shuts off the gas or air supply safely.

#### Flow rate regulator VRH

Type	Designation of regulator type
VRH	Flow rate regulator

Flow rate regulator VRH for maintaining a constant gas/air ratio for modulating-controlled and stage-controlled burners. The gas flow rate is controlled proportionally to the air flow rate.

#### Pressure regulators with double solenoid valve VCD, VCG, VCV, VCH

Type	Combination of gas solenoid valve + regulator with solenoid valve
VCD	VAS + VAD
VCG	VAS + VAG
VCV	VAS + VAV
VCH	VAS + VAH

Gas solenoid valves VAS for safeguarding gas or air on various appliances. Pressure regulators with double solenoid valve VCx are combinations of two gas solenoid valves with a pressure regulator.

This function is only guaranteed when used within the specified limits – see page 16 (Technical data). Any other use is considered as non-compliant.

### Type code

Code	Description
<b>VAD</b>	Pressure regulator with solenoid valve
<b>VAG</b>	Air/gas ratio control with solenoid valve
<b>VAV</b>	Variable air/gas ratio control with solenoid valve
<b>VAH</b>	Flow rate regulator with solenoid valve
<b>VRH</b>	Flow rate regulator
<b>1-3</b>	Size
<b>T</b>	T-product
<b>15-50</b>	Nominal inlet and outlet diameter
<b>R</b>	Rp internal thread
<b>N</b>	NPT internal thread
<b>F</b>	ISO flange
<b>/N<sup>1)</sup></b>	Quick opening, quick closing
<b>K<sup>1)</sup></b>	Mains voltage: 24 V DC
<b>P<sup>1)</sup></b>	Mains voltage: 100 V AC; 50/60 Hz
<b>Q<sup>1)</sup></b>	Mains voltage: 120 V AC; 50/60 Hz
<b>Y<sup>1)</sup></b>	Mains voltage: 200 V AC; 50/60 Hz
<b>W<sup>1)</sup></b>	Mains voltage: 230 V AC; 50/60 Hz
<b>S<sup>1)</sup></b>	Closed position indicator
<b>G<sup>1)</sup></b>	Closed position indicator for 24 V
<b>R<sup>1)</sup></b>	Viewing side (in flow direction): from the right
<b>L<sup>1)</sup></b>	Viewing side (in flow direction): from the left
	Outlet pressure $p_d$ for VAD:
<b>-25</b>	2.5–25 mbar
<b>-50</b>	20–50 mbar
<b>-100</b>	35–100 mbar
<b>A</b>	Standard valve seat
<b>B</b>	Reduced valve seat
	Connection kit for air control pressure $p_{sa}$ :
<b>E</b>	VAG, VAV, VAH, VRH: compression fitting
<b>K</b>	VAG, VAV: plastic hose coupling
<b>A</b>	VAG, VAV, VAH, VRH: NPT 1/8 adapter
<b>N</b>	VAG: zero governor

<sup>1)</sup> Only available for VAD, VAG, VAV, VAH

### Part designations

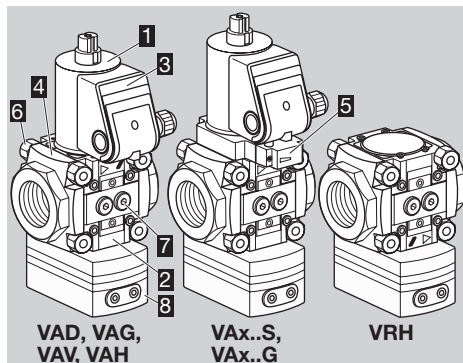

- 1 Solenoid actuator
- 2 Flow body
- 3 Connection box
- 4 Connection flange
- 5 Closed position indicator CPI
- 6 Connection parts
- 7 Sealing plug
- 8 Regulator

Mains voltage, electrical power consumption, ambient temperature, enclosure, inlet pressure and installation position: see type label.

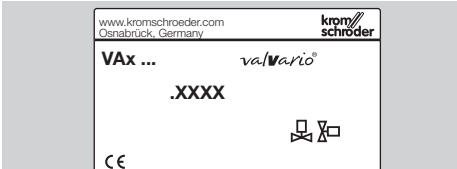

## Installation

### ! CAUTION

Please observe the following to ensure that the unit is not damaged during installation and operation:

- Dropping the device can cause permanent damage. In this event, replace the entire device and associated modules before use.
- Important! The gas must be dry in all conditions and must not contain condensate.
- Sealing material and dirt, e.g. thread cuttings, must not be allowed to get into the valve housing. Install a filter upstream of every system.
- Always install an activated carbon filter upstream of the regulator when air is the medium. Otherwise, the ageing of elastomer materials will be accelerated.
- It is not permitted to install gas solenoid valve VAS downstream of flow rate regulator VAH/VRH and upstream of fine-adjusting valve VMV. The VAS would no longer be able to perform its function as a second safety valve if installed in the above-mentioned position.
- Do not store or install the unit in the open air.
- If more than three valVario controls are installed in line, the controls must be supported.
- Do not clamp the unit in a vice. Only secure the flange by holding the octagon with a suitable spanner. Risk of external leakage.
- Devices with POC/CPI VAX..SR/SL: actuator cannot be rotated.
- In the case of double solenoid valves, the position of the connection box can only be changed by removing the actuator and reinstalling it rotated by 90° or 180°.
- Cleaning work on the solenoid actuator may not be performed using high pressure and/or chemical cleaning agents. This can cause moisture to get into the solenoid actuator and may lead to a dangerous failure.

- Note the inlet and outlet pressures, see page 16 (Technical data).

- ▷ When using a non-return gas valve GRS, we recommend installing the non-return gas valve upstream of the regulator and downstream of the gas solenoid valves due to the permanent pressure loss on the GRS.
- ▷ When joining two valves, determine the position of the connection boxes, push through the knock-outs in the connection boxes and install a cable gland set before installation in the pipework. Order No. for cable gland set:  
Size 1: 74921985, size 2: 74921986, size 3: 74921987.
- ▷ Install the unit in the pipe free of mechanical stress.
- ▷ For retrofitting a second gas solenoid valve, use the double block seal instead of O-rings.  
Order No. for seal set:  
Size 1: 74921988, size 2: 74921989, size 3: 74921990.

- ▷ Installation position:  
VAD, VAG, VAH: black solenoid actuator in the vertical upright position or tilted up to the horizontal, not upside down.  
VAG/VAH/VRH in the horizontal position with modulating control: min. inlet pressure  $p_{u \text{ min.}} = 80 \text{ mbar (32 "WC)}$ .  
VAV: black solenoid actuator in the vertical position, not upside down.

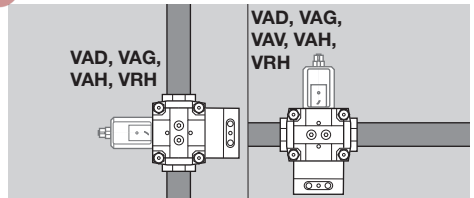

- ▷ The housing must not be in contact with masonry. Minimum clearance 20 mm (0.78").
- ▷ To prevent vibrations, keep the volume between the regulator and burner small by using short pipes ( $\leq 0.5 \text{ m, } \leq 19.7"$ ).
- ▷ The inlet pressure  $p_u$  can be measured using pressure test points on the flow body on both sides.

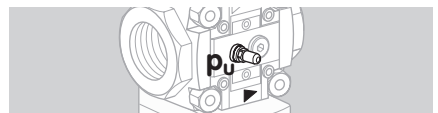

- ▷ The outlet pressure  $p_d$  ( $p_{d1}$  and  $p_{d2}$ ) and the air control pressure  $p_{sa}$  ( $p_{sa1}$  and  $p_{sa2}$ ) must only be measured at the designated places on the regulator using pressure test points.

## VAD

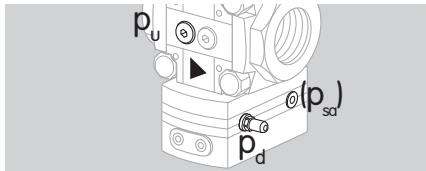

- ▷ A combustion chamber control line ( $p_{sc}$ ) can be connected at connection  $p_{sa}$  to keep the burner capacity constant (1/8" coupling with compression fitting for 6 x 1 tube).

## VAG

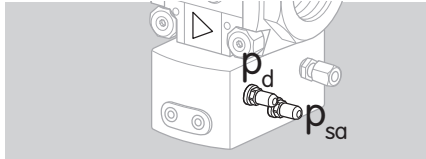

## VAV

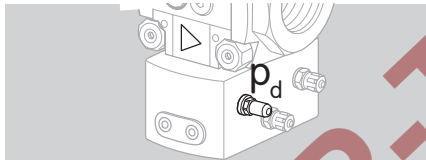

## VAH, VRH

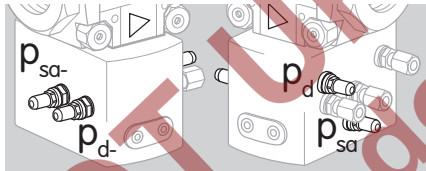

- ▷ To increase the control accuracy, an external impulse line can be connected, instead of the pressure test point  $p_d$ :  
Gas impulse line  $p_d$ : distance from flange  $\geq 3 \times DN$ , use a steel tube 8 x 1 mm and a G1/8.. coupling for D = 8 mm.

## ! CAUTION

Do not bridge downstream VAS with external impulse line.

## Strainer

- ▷ A strainer must be fitted in the unit on the inlet side. If two or more gas solenoid valves are installed in line, then a strainer only needs to be fitted on the inlet side of the first valve.

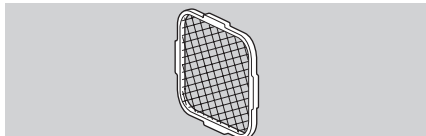

## Differential pressure orifice

- ▷ An appropriate differential pressure orifice with rubber seals (**G**) must be inserted at the outlet of the unit, depending on the pipe.

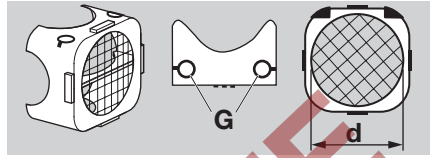

Size	Pipe	Differential pressure orifice Colour/Outlet diameter $\varnothing$
1	DN 15	yellow/ $\varnothing$ 18,5 mm
1	DN 20	green/ $\varnothing$ 25 mm
1	DN 25	transparent/ $\varnothing$ 30 mm
2	DN 40	transparent/ $\varnothing$ 46 mm
3	DN 50	transparent/ $\varnothing$ 58 mm

- ▷ If pressure regulator VAD/VAG/VAV 1 is retrofitted upstream of gas solenoid valve VAS 1, a DN 25 differential pressure orifice with outlet opening  $d = 30$  mm (1.18") must be inserted at the outlet of the pressure regulator.  
In the case of pressure regulator VAX 115 or VAX 120, the DN 25 differential pressure orifice must be ordered separately and retrofitted, Order No. 74922240.
- ▷ The retaining frame must be fitted to secure the differential pressure orifice at the outlet of the regulator.

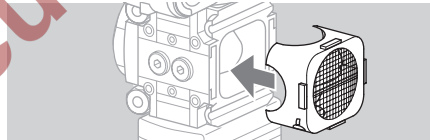

## Retaining frame

- ▷ If two controls (regulators or valves) are assembled, a retaining frame with double block seal must be fitted.

Order No. for seal set:

Size 1: 74921988, size 2: 74921989, size 3: 74921990.

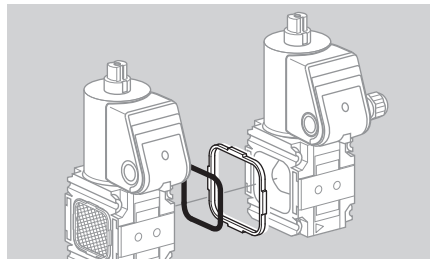

- ▷ The seals in some gas compression fittings are approved for temperatures of up to 70°C (158°F). This temperature limit will not be exceeded if the flow through the pipe is at least 1 m<sup>3</sup>/h (35.31 SCFH) of gas and the maximum ambient temperature is 50°C (122°F).

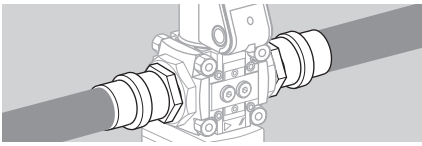

### Regulator with flanges

- 1 Note direction of flow.

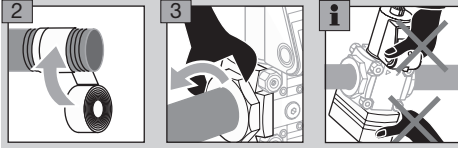

### Regulator without flanges

- 1 Note direction of flow.

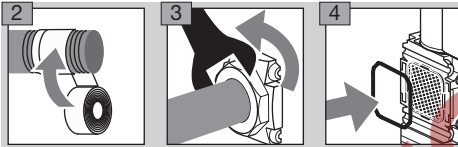

- ▷ O-ring and strainer (Fig. 4) must be fitted.

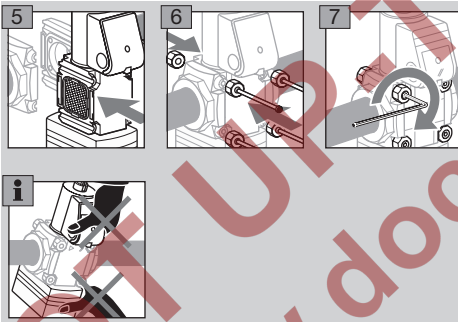

## Installing the gas/air control lines

### ! CAUTION

Please observe the following to ensure that the unit is not damaged during operation:

- Fit control lines so that no condensation can enter the unit.
- The control lines must be as short as possible. Internal diameter  $\geq 3.9$  mm (0.15").
- Any bends, restriction points, deviations or air control valves must be at a distance of at least  $5 \times DN$  from the connection.
- Pressures, adjusting range, transmission ratio and pressure differentials, see page 16 (Technical data).

## VAG

### Installing the air control line $p_{sa}$

- 1 Install the connection for the air control line in the centre of a straight pipeline which is at least  $10 \times DN$  long.
- ▷ VAG..K: 1 1/8" coupling for plastic hose (internal dia. 3.9 mm (0.15"), external dia. 6.1 mm (0.24")) or
  - VAG..E: 1 1/8" coupling with compression fitting for  $6 \times 1$  tube.
  - ▷ VAG..N: connection  $p_{sa}$  must remain open.

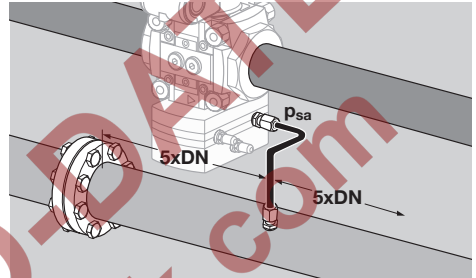

## VAV

### Installing the air control line $p_{sa}$ and the combustion chamber control line $p_{sc}$

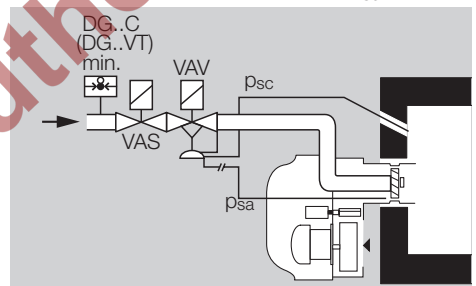

- ▷ VAV..K: 2 plastic hose couplings (internal dia. 3.9 mm (0.15"); external dia. 6.1 mm (0.24")) available.
- ▷ Do not remove the couplings or replace them with other types of coupling.
- 1 Route air control line  $p_{sa}$  and combustion chamber control line  $p_{sc}$  to the test points for air and combustion chamber pressure.
- ▷ If  $p_{sc}$  is not connected, do not plug the opening!
- 2 Install the connection for the air control line in the centre of a straight pipeline which is at least  $10 \times DN$  long.

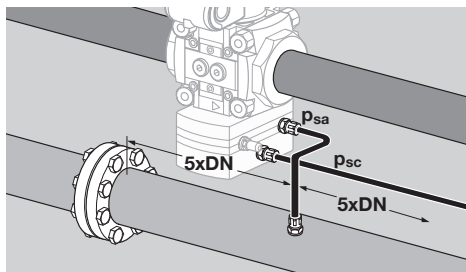

## VAH/VRH

### Installing the air control lines $p_{sa}/p_{sa-}$ and the gas control line $p_d$ .

▷ 3 1/8" couplings with compression fitting for 6 x 1 tube.

**1** To measure the differential air pressure, install a measuring orifice in the air line, ensuring that the inlet and outlet section is  $\geq 5$  DN.

**2** Connect the air control line  $p_{sa}$  to the inlet of the measuring orifice and the air control line  $p_{sa-}$  to the outlet of the measuring orifice.

▷  $p_d$  is an internal hole/feedback in the unit.

## VAH

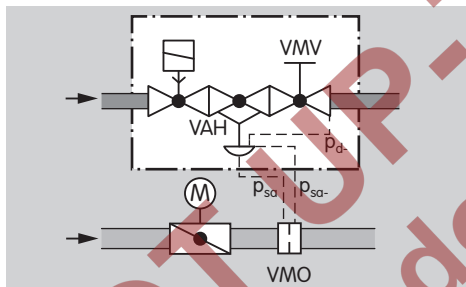

## VRH

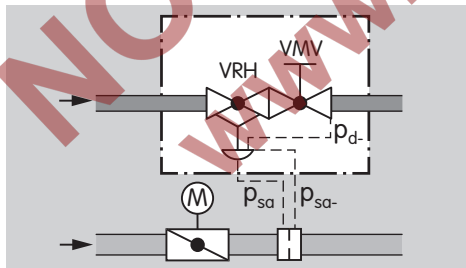

**3** We recommend installing a fine-adjusting valve VMV directly downstream of the regulator in the gas line. See "Filter module VMF, measuring orifice VMO, fine-adjusting valve VMV" operating instructions. The instruction manual can also be found at [www.docuthek.com](http://www.docuthek.com).

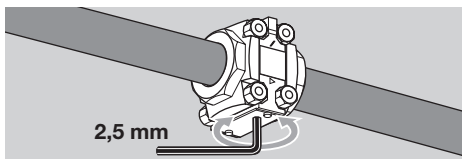

▷ If, instead of installing a VMV, a measuring orifice is installed in the gas line, ensure that the inlet and outlet section is  $\geq 5$  DN.

**4** Connect the gas control line  $p_d$  to the VMV or to the measuring orifice.

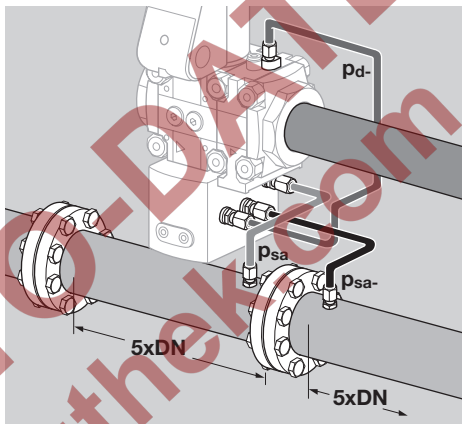

## Wiring

### ⚠ WARNING

Please observe the following to ensure that no damage occurs:

- Electric shocks can be fatal! Before working on possible live components, ensure the unit is disconnected from the power supply.
- The solenoid actuator heats up during operation. Surface temperature approx. 85°C (approx. 185°F).



## VAD, VAG, VAV, VAH

▷ Use temperature-resistant cable ( $> 90^\circ\text{C}$ ).

**1** Disconnect the system from the electrical power supply.

**2** Shut off the gas supply.

▷ Wiring to EN 60204-1.

▷ UL requirements for the NAFTA market. To maintain the UL environmental rating Type 2, the enclosure openings shall be closed with fittings rated UL Type 2; 3; 3R; 3RX; 3S; 3SX; 3X; 4X; 5; 6; 6P; 12; 12K or 13. Gas solenoid valves shall be protected by a branch circuit protective device not exceeding 15 A.

- ▷ When joining two valves, install a cable gland set between the connection boxes.  
Order No. for cable gland set:  
Size 1: 74921985, size 2: 74921986, size 3: 74921987.

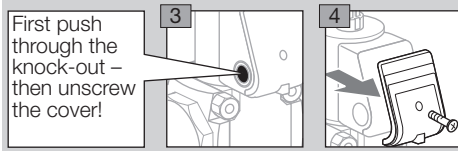

- ▷ If the M20 cable gland or plug is already fitted, it is not necessary to push through the knock-out.

### M20 cable gland

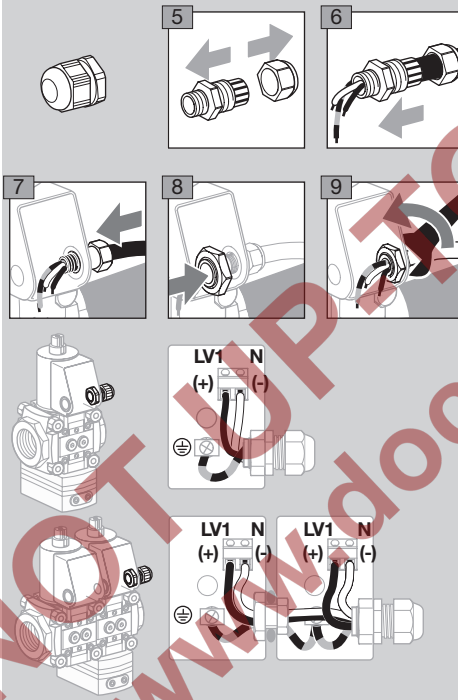

### Plug

LV1<sub>V1</sub> (+) = black, LV1<sub>V2</sub> (+) = brown, N (-) = blue

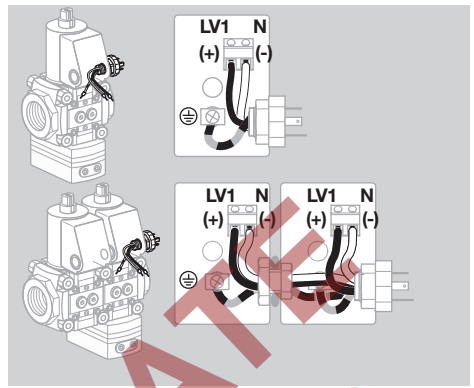
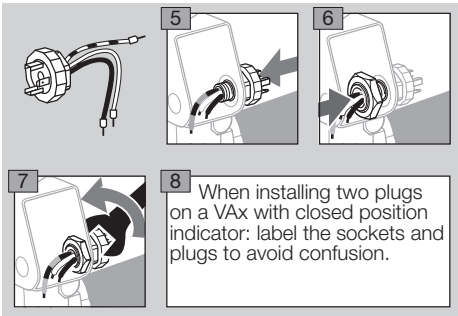

### Socket

1 = N (-), 2 = LV1<sub>V1</sub> (+), 3 = LV1<sub>V2</sub> (+)

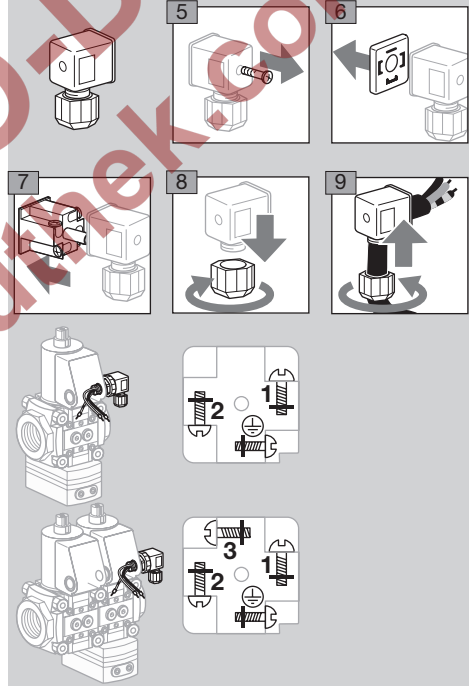

### Closed position indicator

- ▷ VAX open: contacts **1** and **2** closed, VAX closed: contacts **1** and **3** closed.
- ▷ Indicator of CPI: red = VAX closed, white = VAX open.
- ▷ Double solenoid valve: if a plug with socket is fitted, either the POC or the CPI can be connected.

## ! CAUTION

Please observe the following to ensure smooth operation:

- The closed position indicator is not suitable for frequent cycling operation.
- Route valve and closed position indicator cables separately through M20 cable glands or use two separate plugs. Otherwise, there is a risk of interference between valve voltage and closed position indicator voltage.

- ▷ To make wiring easier, the connection terminal for the closed position indicator can be removed.

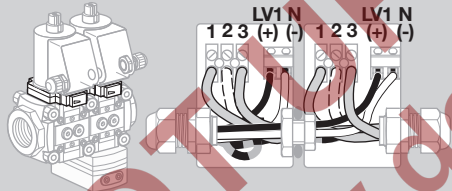
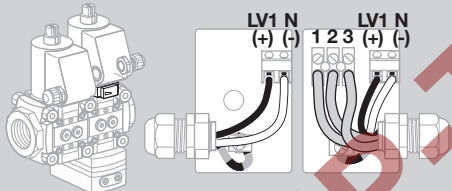
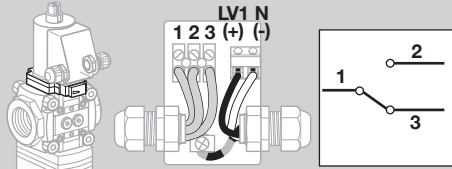

LV1<sub>V1</sub> (+) = black, N (-) = blue

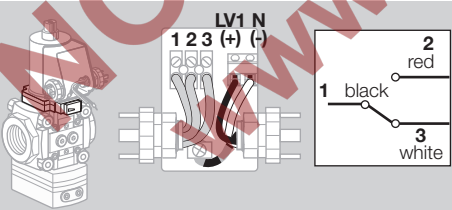

- ▷ Label the plugs to avoid confusion.

1 = N (-), 2 = LV1<sub>V1</sub> (+)

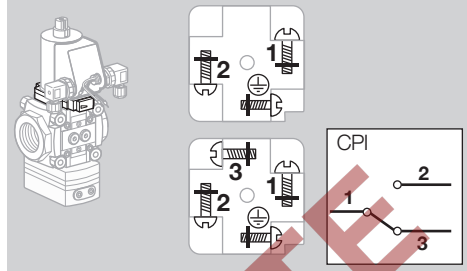

- ▷ Ensure that the connection terminal for the CPI has been reconnected.

## Finishing the wiring

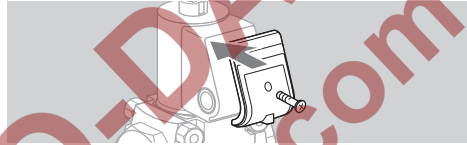

## Tightness test

- 1 Close the gas solenoid valve.
- 2 To be able to check the tightness, shut off the downstream pipeline close to the regulator.
  - ▷ On the VAH/VRH, the control line  $p_d$  leads to gas-filled space in the regulator. It must be connected before the tightness test.

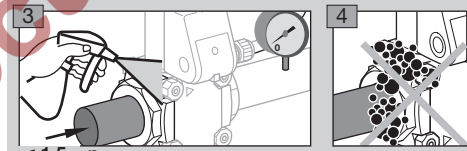

$\leq 1,5 \times p_{u \max}$

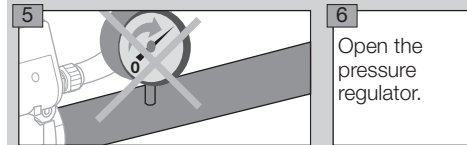

5

6 Open the pressure regulator.

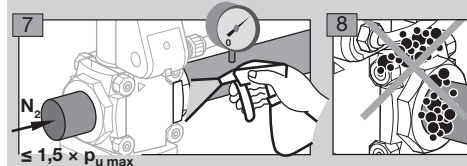

7

$\leq 1,5 \times p_{u \max}$

- 9 Tightness OK: open the pipeline.
  - ▷ Pipeline leaking: replace O-ring on flange.  
Order No. for seal set:  
Size 1: 74921988, size 2: 74921989, size 3: 74921990.  
Then check for tightness once again.
  - ▷ Unit leaking: remove the pressure regulator and return it to the manufacturer.



## Commissioning

- ▷ During the measurement process, ensure that the length of the tube is as short as possible for the determining of the pressures.

### VAD

#### Setting the outlet pressure $p_d$

- ▷ The outlet pressure is set to  $p_d = 10$  mbar at the factory.

	[mbar]	$p_d$	["WC]
VAD...-25	2.5–25		1–10
VAD...-50	20–50		8–19.7
VAD...-100	35–100		14–40

- 1 Switch on the burner.
- ▷ Breathing orifice **A** must remain open.
- 2 Set the regulator to the required outlet pressure.

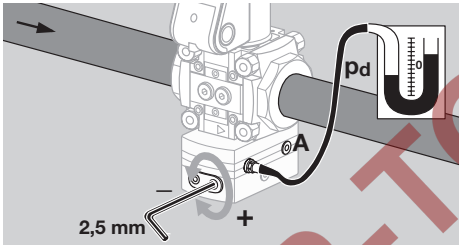

- 3 Close off the test point again once the pressure has been set.

### VAG

$p_d$  = outlet pressure

$p_{sa}$  = air control pressure

- ▷ Factory setting:  $p_d = p_{sa} - 1.5$  mbar (0.6 "WC); actuator pointing upwards and an inlet pressure of 20 mbar (7.8 "WC).

- 1 Switch on the burner.

#### Setting the low-fire rate

- ▷ In applications with excess air, the values for  $p_d$  and  $p_{sa}$  may be below the limit, see Technical data, page 16 (VAG). No situation which would jeopardize safety must arise. Avoid CO formation.

- 2 Set the regulator to the required outlet pressure.

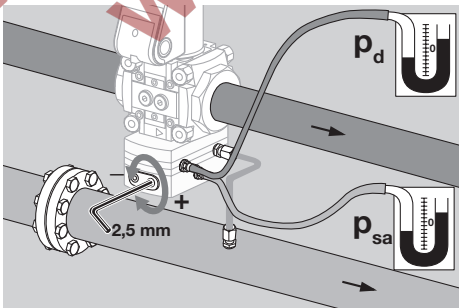

- 3 Close off the test point again once the pressure has been set.

### Setting the high-fire rate

- ▷ Set the high-fire rate using restricting orifices or adjustment elements on the burner.

### VAV

$p_d$  = outlet pressure

$p_{sa}$  = air control pressure

$p_{sc}$  = combustion chamber control pressure

#### Setting the low-fire rate

- ▷ If the burner operates at low-fire rate, the gas/air mixture can be changed by adjusting the adjusting screw "N".

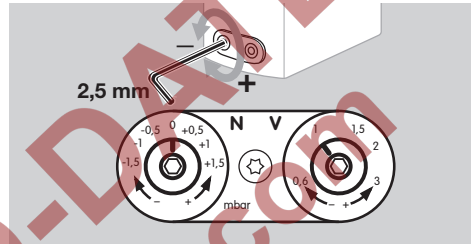

### ! CAUTION

$p_{sa} - p_{sc} \geq 0.4$  mbar ( $\geq 0.15$  "WC).

Controller acting time for the reference variable (air butterfly valve):

min. to max. > 5 s, max. to min. > 5 s.

- ▷ Factory setting for transmission ratio of gas to air:  $V = 1:1$ , zero point  $N = 0$ .

### Pre-setting

- 1 Set zero point **N** and transmission ratio **V** to scale in accordance with burner manufacturer's specifications.
- 2 Measure gas pressure  $p_d$ .

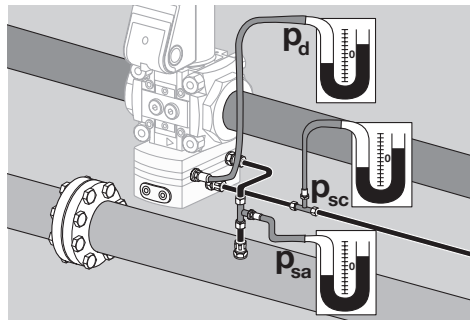

- 3 Start the burner at low-fire rate. If the burner does not start, turn **N** slightly in direction + and repeat start.
- 4 Gradually increase the burner to high fire and, if necessary, adjust the gas pressure at **V**.
- 5 Set the minimum and maximum capacity on the air control valve in accordance with burner manufacturer's specifications.

## Final adjustment

- 6 Set the burner to low fire.
  - 7 Conduct a flue gas analysis and set the gas pressure at **N** to the desired analysis value.
  - 8 Set the burner to high fire and set the gas pressure at **V** to the desired analysis value.
  - 9 Repeat the analysis at low and high fire and correct **N** and **V** if necessary.
  - 10 Close off all test points. Do not close off connection  $p_{sc}$  if not used!
- ▷ It is advisable to start the burner at a level higher than the minimum setting (start gas rate) to ensure reliable flame formation.

## Calculation

If the combustion chamber control pressure  $p_{sc}$  is not connected:

$$p_d = V \times p_{sa} + N$$

If combustion chamber control pressure  $p_{sc}$  is connected:

$$(p_d - p_{sc}) = V \times (p_{sa} - p_{sc}) + N$$

## Testing control capacity

### ⚠ DANGER

Risk of explosion! If the control capacity is insufficient, the system may not be operated.

- 11 Set the burner to high fire.
- 12 Measure the gas pressure at the inlet and outlet.
- 13 Slowly close the manual valve upstream of the regulator until the gas inlet pressure  $p_i$  drops.
  - ▷ The gas outlet pressure  $p_d$  should not drop as well. Otherwise, the setting should be re-checked and adjusted.
- 14 Reopen the manual valve.

## VAH, VRH

$p_i$  = inlet pressure

$p_d$  = outlet pressure

$\Delta p_d$  = differential gas pressure (outlet pressure)

$p_{sa}$  = air control pressure

$\Delta p_{sa}$  = differential air pressure (air control pressure)

▷ A gas/air mixture may be applied at the  $p_{sa}$ -connection for the air control pressure.

- ▷ Inlet pressure  $p_i$ : max. 500 mbar
- ▷ Air control pressure  $p_{sa}$ : 0.6 to 100 mbar
- ▷ Differential air pressure  $\Delta p_{sa}$  ( $p_{sa} - p_{sa-}$ ) = 0.6 to 50 mbar
- ▷ Differential gas pressure  $\Delta p_d$  ( $p_d - p_d-$ ) = 0.6 to 50 mbar
- ▷ The impulse lines  $p_{sa}$ ,  $p_{sa-}$  and  $p_d-$  must be laid correctly.

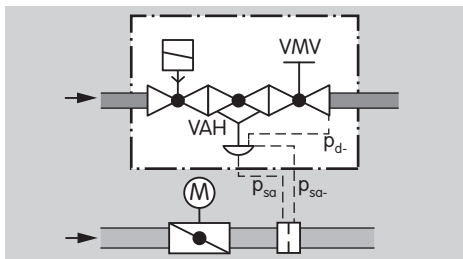

## Pre-setting

- 1 Set the minimum and maximum capacity on the air control valve in accordance with burner manufacturer's specifications.
- 2 Switch on the burner.

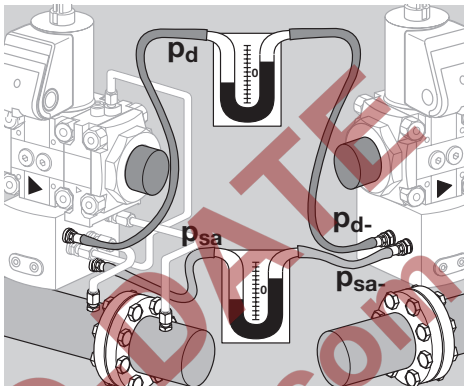

- 3 Open the fine-adjusting valve VMV slowly, from the ignitable mixture with excess air to the required value.

## Setting the high-fire rate

- 4 Slowly increase the burner to high fire and set the differential gas pressure on the fine-adjusting valve VMV in accordance with burner manufacturer's specifications.

## Setting the low-fire rate

- ▷ If the burner operates at low-fire rate, the gas/air mixture can be changed by adjusting the adjusting screw **N**.

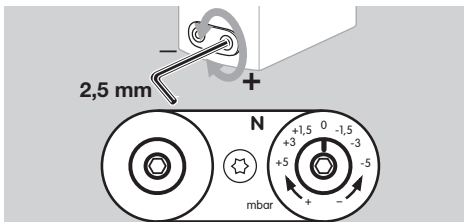

- ▷ Factory setting: zero point **N** = -1.5 mbar

### ! CAUTION

$\Delta p_{sa} = p_{sa} - p_{sa-} \geq 0.6 \text{ mbar}$  ( $\geq 0.23 \text{ "WC}$ ).  
Controller acting time for the reference variable (air butterfly valve): min. to max. > 5 s, max. to min. > 5 s.

- 5 Set the burner to low fire.
- 6 Conduct a flue gas analysis and set the gas pressure at **N** to the desired analysis value.
- 7 Set the burner to high fire and set the differential gas pressure to the desired analysis value.
- 8 Repeat the analysis at low and high fire and correct if necessary.
- 9 Close off all test points.

## Replacing the actuator

See operating instructions enclosed with spare part or see [www.docuthek.com](http://www.docuthek.com).

## Maintenance

### ! CAUTION

In order to ensure smooth operation, check the tightness and function of the pressure regulator:

- Once per year, twice per year in the case of biogas; check for internal and external tightness, see page 8 (Tightness test).
  - Check electrical installations once a year in line with local regulations; pay particular attention to the PE wire, see page 6 (Wiring).
- ▷ If more than one valVario control is installed in series: the controls may only be removed from the pipeline and reinstalled on the inlet and outlet flange all at once.
- ▷ We recommend replacing the seals, see page 15 (Seal set for sizes 1–3).
- ▷ If the flow rate has dropped, clean the strainer and the differential pressure orifice.

- 1 Disconnect the system from the electrical power supply.
- 2 Shut off the gas supply.
- 3 Detach control line(s).

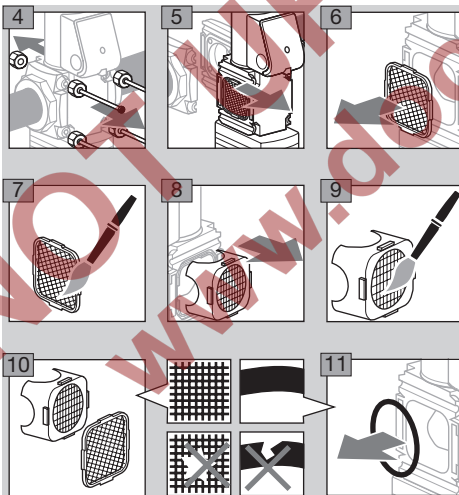

- 12 Once the seals have been replaced, refit the strainer and the differential pressure orifice and install the pressure regulator in the pipeline again.
- 13 Reattach control line(s) to the regulator.
  - ▷ The pressure regulator remains closed.
- 14 Then check the unit for internal and external tightness, see page 8 (Tightness test).

## Accessories

### Pressure switch for gas DG..VC

- ▷ The pressure switch for gas monitors the inlet pressure  $p_U$ , the outlet pressure  $p_D$  and the interspace pressure  $p_Z$ .

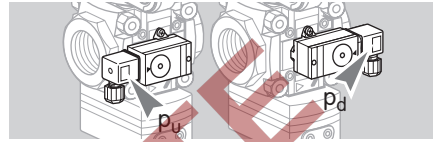

- ▷ When using two pressure switches on the same side of the double solenoid valve, only the combination DG..C..1 and DG..C..9 may be used for design reasons.

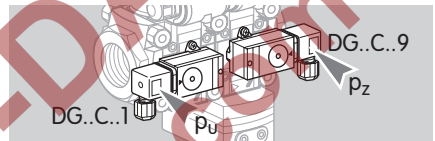

- ▷ When retrofitting the pressure switch for gas, see enclosed operating instructions “Pressure switches for gas DG..C”, section entitled “Mounting the DG..C..1, DG..C..9 on valVario gas solenoid valves”.
- ▷ The switching point is adjustable via hand wheel.

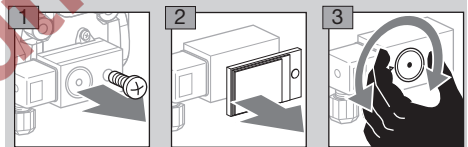

	Adjusting range (adjusting tolerance = ± 15% of the scale value)		Mean switching differential at min. and max. setting	
	[mbar]	[“WC]	[mbar]	[“WC]
DG 17VC	2–17	0.8–6.8	0.7–1.7	0.3–0.8
DG 40VC	5–40	2–16	1–2	0.4–1
DG 110VC	30–110	12–44	3–8	0.8–3.2
DG 300VC	100–300	40–120	6–15	2.4–8

- ▷ Deviation from the switching point during testing pursuant to EN 1854 Gas pressure switches: ± 15%.

## Bypass/pilot gas valves

- 1 Disconnect the system from the electrical power supply.
  - 2 Shut off the gas supply.
  - 3 Prepare the installed main valve.
- ▷ Turn the actuator so that the side on which the bypass/pilot gas valve is to be installed is accessible.

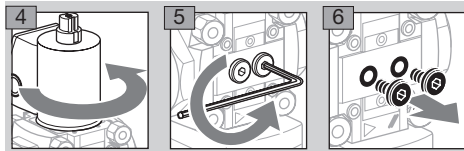

## VBY for VAX 1

### Scope of delivery

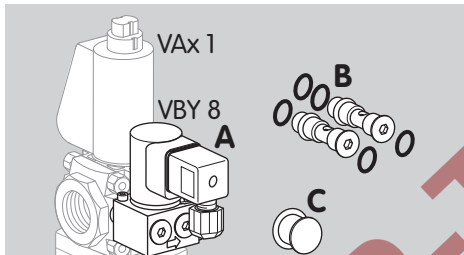

### Bypass valve VBY..I

- A 1 x bypass valve VBY..I
  - B 2 x retaining screws with 4 x O-rings: both retaining screws have a bypass orifice
  - C Grease for O-rings
- ▷ The screw plug at the outlet remains in place.

### Pilot gas valve VBY..R

- A 1 x pilot gas valve VBY..R
  - B 2 x retaining screws with 5 x O-rings: one retaining screw has a bypass orifice (2 x O-rings), the other does not (3 x O-rings)
  - C Grease for O-rings
- ▷ Remove the screw plug at the outlet and connect the Rp 1/4 pilot gas line.

### Mounting the VBY

- 7 Grease O-rings B.

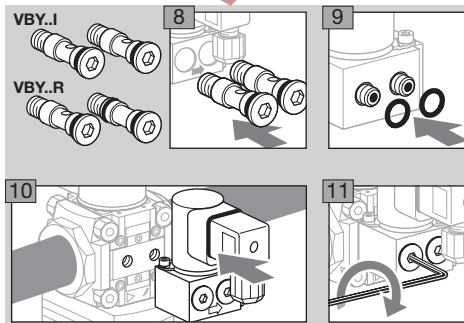

- ▷ Tighten the retaining screws alternately so that VBY and the main valve are flush.

## Setting the flow rate

- ▷ The flow rate can be set by turning the flow rate restrictor (4 mm hexagon socket) 1/4 of a turn.

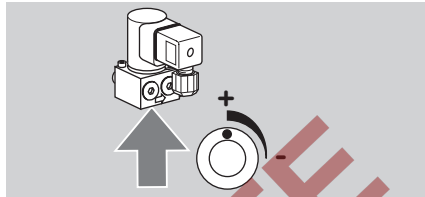

- ▷ Only adjust the flow rate restrictor in the marked range, otherwise the required gas volume will not be reached.
- 12 Wire the socket, see page 6 (Wiring).
  - 13 Check for tightness, see page 13 (Checking the bypass/pilot gas valve for tightness).

## VAS 1 for VAX 1, VAX 2, VAX 3

### Scope of delivery

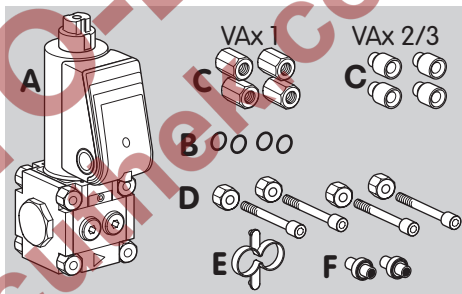

- A 1 x bypass/pilot gas valve VAS 1
- B 4 x O-rings
- C 4 x double nuts for mounting to VAS 1 or 4 x spacer sleeves for mounting to VAS 2/3
- D 4 x connection parts
- E 1 x mounting aid

### Bypass valve VAS 1

- F 2 x connection pipes, if the bypass valve has a blind flange on the outlet side.

### Pilot gas valve VAS 1

- F 1 x connection pipe, 1 x sealing plug, if the pilot gas valve has a threaded flange on the outlet side.

## Mounting the bypass/pilot gas valve VAS 1

- ▷ Always use a connection pipe **F** at the inlet of the main valve.
- ▷ For a bypass valve: use connection pipe **F** Ø 10 mm (0.39") at the outlet of the main valve if the bypass valve's outlet flange is designed as a blind flange.
- ▷ For the pilot gas valve: insert sealing plug **F** at the outlet of the main valve if the pilot gas valve's outlet flange is designed as a threaded flange.

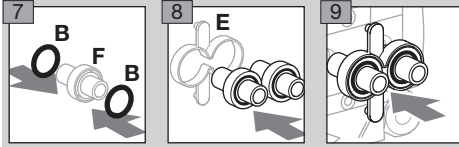

- 10** Remove the sealing plugs on the mounting side of the bypass valve.

### VAS 1 to VAX 1

- 11** Remove the nuts from the connection parts on the mounting side of the main valve.
- 12** Remove the connection parts of the bypass/pilot gas valve.
- ▷ Use the new connection parts **C** and **D** from the scope of delivery for the bypass/pilot gas valve.

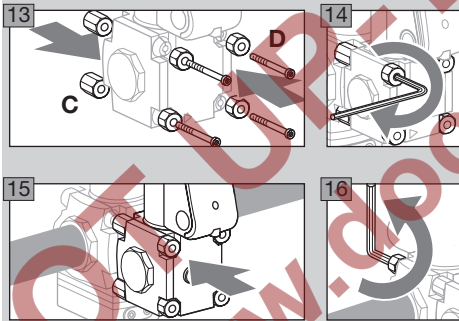

- 17** Wire the bypass/pilot gas valve VAS 1, see page 6 (Wiring).
- 18** Check for tightness, see page 13 (Checking the bypass/pilot gas valve for tightness).

## VAS 1 for VAX 2 or VAX 3

- ▷ The connection parts of the main valve remain mounted.
- 11** Remove the connection parts of the bypass/pilot gas valve.
- ▷ Use the new connection parts **C** and **D** from the scope of delivery for the bypass/pilot gas valve. For VAX 2 and VAX 3, the connection parts consist of self-tapping screws.

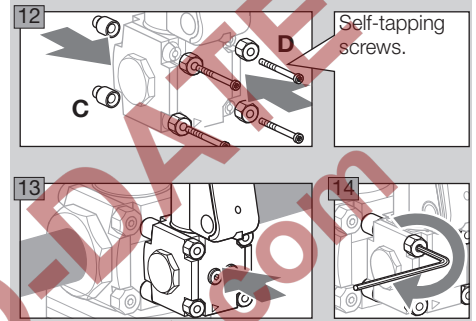

- 15** Wire the bypass/pilot gas valve VAS 1, see page 6 (Wiring).
- 16** Check for tightness, see page 13 (Checking the bypass/pilot gas valve for tightness).

### Checking the bypass/pilot gas valve for tightness

- 1** To be able to check the tightness, shut off the downstream pipeline as close as possible to the valve.
- 2** Close the main valve.
- 3** Close the bypass/pilot gas valve.

### ! CAUTION

If the actuator of the VBY is rotated, the tightness can no longer be guaranteed. To ensure that there are no leaks, check the actuator of the VBY for tightness.

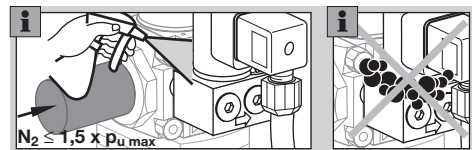

Check the bypass/pilot gas valve for tightness at the inlet and outlet.

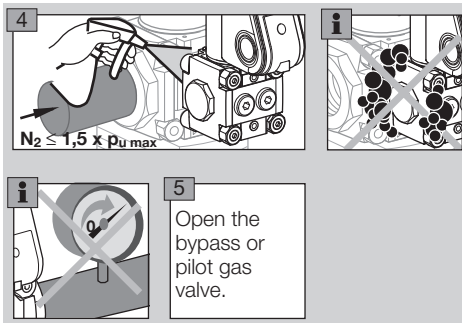

### Bypass valve

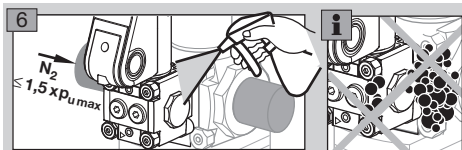

5 Open the bypass or pilot gas valve.

### Pilot gas valve

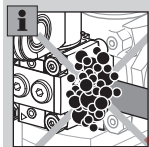
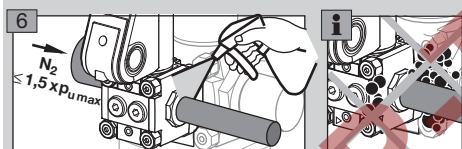

### Cable gland set for double solenoid valves

- ▷ When wiring a double solenoid valve, the connection boxes are to be connected using a cable gland set.

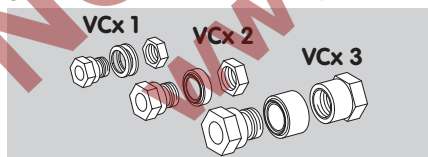

- ▷ Order No. for size 1: 74921985, size 2: 74921986, size 3: 74921987.
- ▷ We recommend preparing the connection boxes before the double solenoid valve is installed in the pipework. Alternatively, one of the actuators must be dismantled as described below and reinstalled rotated by 90° in preparation for installation of the double solenoid valve.
- ▷ The cable gland set can only be used if the connection boxes are at the same height and on the same side.

- 1 Disconnect the system from the electrical power supply.
- 2 Shut off the gas supply.

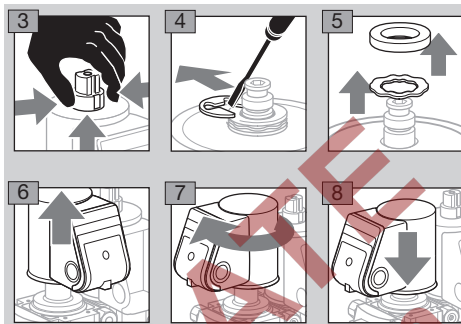

- ▷ In both connection boxes, push through the knock-out for the cable gland set – then remove the covers. The covers must not be taken off before pushing through the knock-outs as it prevents damage to the connection boxes.



## Attachment block

- ▷ For locked installation of pressure gauge or other accessories, the attachment block is mounted to the solenoid valve.

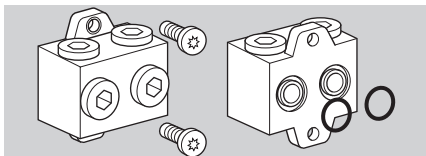

- ▷ Order No. 74922228
- 1 Disconnect the system from the electrical power supply.
- 2 Shut off the gas supply.
- ▷ Use the enclosed self-tapping screws for installation.

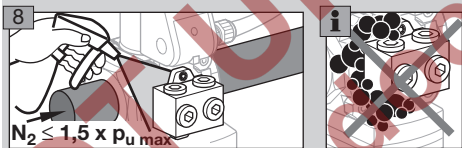
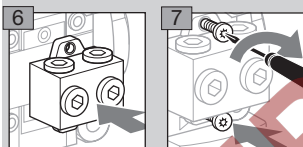
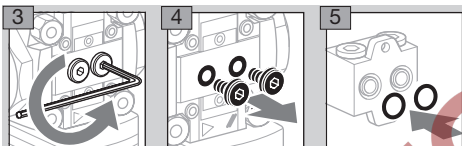

- 9 Shut off the downstream gas pipeline close to the pressure regulator.
- 10 Open the pressure regulator.



## Seal set for sizes 1–3

- ▷ When retrofitting accessories or a second valVario control or when servicing, we recommend replacing the seals.

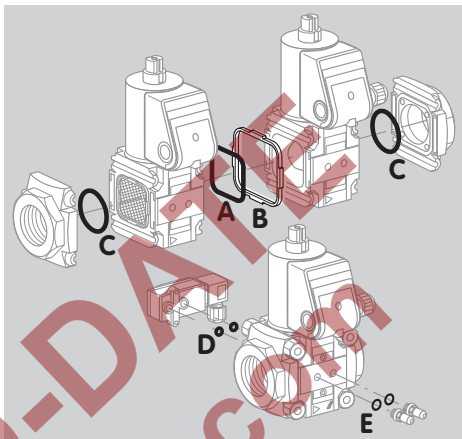

- ▷ Order No. for size 1: Order No. 74921988, size 2: Order No. 74921989, size 3: Order No. 74921990.
- ▷ Scope of delivery:
  - A 1 x double block seal,
  - B 1 x retaining frame,
  - C 2 x O-rings (flange),
  - D 2 x O-rings (pressure switch), for pressure test point/screw plug:
  - E 2 x sealing rings (flat sealing), 2 x profiled sealing rings.

## Cable gland with pressure equalization element

- ▷ To avoid the formation of condensation, the cable gland with pressure equalization element can be used instead of the standard M20 cable gland. The diaphragm in the gland is designed to ventilate the device, without allowing water to enter.
- ▷ 1 x cable gland, Order No.: 74924686

## Technical data

### Ambient conditions

icing, condensation and dew in and on the unit are not permitted.

Avoid direct sunlight or radiation from red-hot surfaces on the unit. Note the maximum medium and ambient temperatures!

Avoid corrosive influences, e.g. salty ambient air or SO<sub>2</sub>.

The unit may only be stored/installed in enclosed rooms/buildings.

The unit is suitable for a maximum installation height of 2000 m AMSL.

Ambient temperature:

VAX: -20 to +60°C (-4 to +140°F),

VBY: 0 to +60°C (32 to 140°F).

Long-term use in the upper ambient temperature range accelerates the ageing of the elastomer materials and reduces the service life (please contact manufacturer).

Enclosure:

VAD, VAG, VAV, VAH: IP 65,

VBY: IP 54.

This unit is not suitable for cleaning with a high-pressure cleaner and/or cleaning products.

### Mechanical data

Gas types: natural gas, LPG (gaseous), biogas (max. 0.1 %-by-vol. H<sub>2</sub>S) or clean air; other types of gas on request.

The gas must be clean and dry in all temperature conditions and must not contain condensate.

Medium temperature → ambient temperature.

CE and FM approved and UL listed, max. inlet pressure p<sub>u</sub>: 10–500 mbar (1–200 "WC).

FM approved, non operational pressure:

700 mbar (10 psig).

ANSI/CSA approved:

350 mbar (5 psig).

Opening times:

VAX...N quick opening: ≤ 1 s,

closing time: quick closing: < 1 s.

Valve housing: aluminium, valve seal: NBR.

Connection flanges with internal thread:

Rp to ISO 7-1, NPT to ANSI/ASME.

Class A, Group 2 safety valve pursuant to EN 13611 and EN 161, 230 V AC, 120 V AC, 24 V DC:

Factory Mutual (FM) Research Class:

7400 and 7411, ANSI Z21.21 and CSA 6.5,

ANSI Z21.18 and CSA 6.3.

Control class A to EN 88-1.

Control range: up to 10:1.

### VAD

Outlet pressure p<sub>d</sub>:

VAD..-25: 2.5–25 mbar (1–10 "WC),

VAD..-50: 20–50 mbar (8–19.7 "WC),

VAD..-100: 35–100 mbar (14–40 "WC).

Combustion chamber control pressure p<sub>sc</sub> (connection p<sub>sa</sub>): -20 to +20 mbar (-7.8 to +7.8 "WC).

### VAG

Outlet pressure p<sub>d</sub>:

0.5–100 mbar (0.2–40 "WC).

Air control pressure p<sub>sa</sub>:

0.5–100 mbar (0.2–40 "WC).

In applications with excess air, p<sub>d</sub> and p<sub>sa</sub> may be below the limit of 0.5 mbar. No situation which would jeopardize safety must arise. Avoid CO formation.

Adjusting range at low fire: ±5 mbar (±2 "WC).

Transmission ratio of gas to air: 1:1.

▷ The inlet pressure must always be higher than the air control pressure p<sub>sa</sub> + pressure loss Δp + 5 mbar (+ 2 "WC).

Connection options for air control pressure p<sub>sa</sub>:

VAG..K: 1 1/8" coupling for plastic hose (internal dia. 3.9 mm (0.15"), external dia. 6.1 mm (0.24")),

VAG..E: 1 1/8" coupling with compression fitting for 6 x 1 tube,

VAG..A: 1 NPT 1/8 adapter,

VAG..N: zero governor with breathing orifice.

### VAV

Outlet pressure p<sub>d</sub>:

0.5–30 mbar (0.2–11.7 "WC).

Air control pressure p<sub>sa</sub>:

0.4–30 mbar (0.15–11.7 "WC).

Combustion chamber control pressure p<sub>sc</sub>:

-20 to +20 mbar (-7.8 to +7.8 "WC).

Min. control pressure differential p<sub>sa</sub> - p<sub>sc</sub>:

0.4 mbar (0.15 "WC).

Min. pressure differential p<sub>d</sub> - p<sub>sc</sub>:

0.5 mbar (0.2 "WC).

Adjusting range at low fire:

±1.5 mbar (±0.6 "WC).

Transmission ratio of gas to air: 0.6:1 – 3:1.

▷ The inlet pressure p<sub>d</sub> must always be higher than the air control pressure p<sub>sa</sub> x transmission ratio V + pressure loss Δp + 1.5 mbar (0.6 "WC).

Connection of air control pressure p<sub>sa</sub> and combustion chamber control pressure p<sub>sc</sub>:

VAV..K: 2 plastic hose couplings (internal dia. 3.9 mm (0.15"); external dia. 6.1 mm (0.24")) fitted.



## VAH, VRH

- ▷ The inlet pressure must always be higher than the differential air pressure  $\Delta p_{sa}$  + max. gas pressure on burner + pressure loss  $\Delta p$  + 5 mbar (+ 2 "WC).

Differential air pressure  $\Delta p_{sa}$  ( $p_{sa} - p_{sa-}$ ) =  
0.6 – 50 mbar (0.24 – 19.7 "WC).

Differential gas pressure  $\Delta p_d$  ( $p_d - p_{d-}$ ) =  
0.6 – 50 mbar (0.24 – 19.7 "WC).

Adjusting range at low fire:

±5 mbar (±2 "WC).

Connection of air control pressure  $p_{sa}$ :

3 1/8" couplings with compression fitting for  
6 x 1 tube.

## Air flow rate Q

Air flow rate Q for a pressure loss of  $\Delta p = 10$  mbar  
(4 "WC)

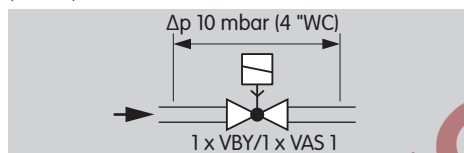

Type	Air flow rate	
	Q [m³/h]	Q [SCFH]
Bypass valve VBY	0.85	30.01
Pilot gas valve VBY	0.89	31.43

Type	Ø [mm]	Air flow rate		
		Q [m³/h]	Ø ["]	Q [SCFH]
Bypass valve VAS 1	1	0.2	0.04	7.8
	2	0.5	0.08	17.7
	3	0.8	0.12	28.2
	4	1.5	0.16	53.1
	5	2.3	0.20	81.2
	6	3.1	0.24	109.5
	7	3.9	0.28	137.7
	8	5.1	0.31	180.1
	9	6.2	0.35	218.9
	10	7.2	0.39	254.2
Pilot gas valve VAS 1	10	8.4	0.39	296.6

## Electrical data

Mains voltage:

230 V AC, +10/-15%, 50/60 Hz;

200 V AC, +10/-15%, 50/60 Hz;

120 V AC, +10/-15%, 50/60 Hz;

100 V AC, +10/-15%, 50/60 Hz;

24 V DC, ±20%.

Cable gland: M20 x 1.5.

Electrical connection: electrical cable with  
max. 2.5 mm² (AWG 12) or plug with socket to  
EN 175301-803.

Power consumption:

Type	Voltage	Power
VAx 1	24 V DC	25 W –
	100 V AC	25 W (26 VA)
	120 V AC	25 W (26 VA)
	200 V AC	25 W (26 VA)
	230 V AC	25 W (26 VA)
VAx 2, VAx 3	24 V DC	36 W –
	100 V AC	36 W (40 VA)
	120 V AC	40 W (44 VA)
	200 V AC	40 W (44 VA)
	230 V AC	40 W (44 VA)
VBY	24 V DC	8 W –
	120 V AC	8 W –
	230 V AC	9.5 W –

Duty cycle: 100%.

Power factor of the solenoid coil:  $\cos \varphi = 0.9$ .

Closed position indicator contact rating:

Type	Voltage	Min. current (resistive load)	Max. current (resistive load)
VAx..S	12–250 V AC, 50/60 Hz	100 mA	3 A
VAx..G	12–30 V DC	2 mA	0.1 A

Closed position indicator switching frequency:  
max. 5 x per minute.

Switching current [A]	Switching cycles*	
	$\cos \varphi = 1$	$\cos \varphi = 0.6$
0,1	500,000	500,000
0,5	300,000	250,000
1	200,000	100,000
3	100,000	–

\* Limited to max. 200,000 cycles for heating  
systems.

## Designed lifetime

This information on the designed lifetime is based on  
using the product in accordance with these operating  
instructions. Once the designed lifetime has been  
reached, safety-relevant products must be replaced.  
Designed lifetime (based on date of manufacture) in  
accordance with EN 13611, EN 161 for Vxx:

Type	Designed lifetime	
	Switching cycles	Time [years]
VAx 110 to 225	500,000	10
VAx 232 to 365	200,000	10
VRH	–	10

You can find further explanations in the applicable  
rules and regulations and on the afecor website  
([www.afecor.org](http://www.afecor.org)).

This procedure applies to heating systems. For  
thermoprocessing equipment, observe local regu-  
lations.

## Logistics

### Transport

Protect the unit from external forces (blows, shocks, vibration).

Transport temperature:

VAX: -20 to +60°C (-4 to +140°F),

VBY: 0 to +60°C (32 to 140°F).

The ambient conditions described apply to transport.

Report any transport damage on the unit or packaging without delay.

Check that the delivery is complete, see page 2 (Part designations).

### Storage

Storage temperature:

VAX: -20 to +40°C (-4 to +104°F),

VBY: 0 to +40°C (32 to 104°F).

Storage is subject to the ambient conditions described.

Storage time: 6 months in the original packaging before using for the first time. If stored for longer than this, the overall service life will be reduced by the corresponding amount of extra storage time.

### Packaging

The packaging material is to be disposed of in accordance with local regulations.

### Disposal

Components are to be disposed of separately in accordance with local regulations.

## Certification

### Declaration of conformity



We, the manufacturer, hereby declare that the products VAD/VAG/VAV/VAH/VRH with product ID No. CE-0063BO1580 comply with the requirements of the listed Directives and Standards.

Directives:

– 2014/35/EU – LVD

– 2014/30/EU – EMC

Regulation:

– (EU) 2016/426 – GAR

Standards:

– EN 161:2011+A3:2013

– EN 88-1:2011+A1:2016

– EN 126:2012

– EN 1854:2010

The relevant product corresponds to the tested type sample.

The production is subject to the surveillance procedure pursuant to Regulation (EU) 2016/426 Annex III paragraph 3.

Elster GmbH

Scan of the Declaration of conformity (D, GB) – see [www.docuthek.com](http://www.docuthek.com)

### SIL, PL

The devices VAD/VAG/VAV/VAH 1–3 are suitable for single-channel systems (HFT = 0) up to SIL 2/PL d, and up to SIL 3/PL e when two redundant solenoid valves are installed in a double-channel architecture (HFT = 1), provided that the complete system complies with the requirements of EN 61508/ISO 13849. The safety function value which is actually achieved is derived by taking all components into account (sensor – logic – actuator). For this, the demand rate and structural measures to avoid/detect nonconformity are to be observed (e.g. redundancy, diversity, monitoring).

**Characteristic values for SIL/PL: HFT = 0 (1 device), HFT = 1 (2 devices), SFF > 90, DC = 0, type A/category B, 1, 2, 3, 4, high demand mode, CCF > 65,  $\beta \geq 2$ .**

$$PFH_D = \lambda_D = \frac{1}{MTTF_d} = \frac{0.1}{B_{10d}} \times n_{op}$$

VAD/VAG/VAV/VAH	B <sub>10d</sub> value
Size 1	10,094,360
Size 2	8,229,021
Size 3	6,363,683

**VAD, VAG, VAV, VAH: FM approved\***



Factory Mutual (FM) Research Class: 7400 and 7411  
Safety overpressure slam shut valves.  
Designed for applications pursuant to NFPA 85 and  
NFPA 86.

**VAD, VAG: ANSI/CSA approved\***



Canadian Standards Association – ANSI Z21.21 and  
CSA 6.5, ANSI Z21.18 and CSA 6.3

**VAD, VAG, VAV: UL listed (for 120 V only)**



Underwriters Laboratories – UL 429  
“Electrically operated valves”.

**VAD, VAG, VAV: AGA approved\***



Australian Gas Association

**Eurasian Customs Union**



The product VAD/VAG/VAV/VAH/VRH/VCS meets  
the technical specifications of the Eurasian Customs  
Union.

**Directive on the restriction of the use of  
hazardous substances (RoHS) in China**

Scan of the Disclosure Table China RoHS2 – see  
certificates at [www.docuthek.com](http://www.docuthek.com)

\* Approval does not apply for 100 V AC or  
200 V AC.

NOT UP-TO-DATE  
[www.docuthek.com](http://www.docuthek.com)

## Contact

If you have any technical questions, please contact your local branch office/agent. The addresses are available on the Internet or from Elster GmbH.

We reserve the right to make technical modifications in the interests of progress.

**Honeywell**

**krom//  
schroder**

Elster GmbH  
Strotheweg 1, D-49504 Lotte (Büren)

Tel. +49 541 1214-0

Fax +49 541 1214-370

[hts.lotte@honeywell.com](mailto:hts.lotte@honeywell.com), [www.kromschroeder.com](http://www.kromschroeder.com)